

STATE OF NORTH CAROLINA
DEPARTMENT OF TRANSPORTATION
RALEIGH, N.C.

C204410

CONTRACT AND
CONTRACT BONDS
FOR CONTRACT NO. C204410

WBS 38454.3.1 0070245

T.I.P NO. B-4654

COUNTY OF WAKE

THIS IS THE ROADWAY & STRUCTURE CONTRACT

ROUTE NUMBER NC-50 LENGTH 0.396 MILES

LOCATION BRIDGE #69 OVER US-70 ON NC-50 (BENSON RD).

CONTRACTOR BLYTHE CONSTRUCTION INC

ADDRESS P.O. BOX 31635

CHARLOTTE, NC 28231

BIDS OPENED APRIL 16, 2024

CONTRACT EXECUTION 05/08/2024

STATE OF NORTH CAROLINA
DEPARTMENT OF TRANSPORTATION
RALEIGH, N.C.

PROPOSAL

DATE AND TIME OF BID OPENING: **Apr 16, 2024 AT 02:00 PM**

CONTRACT ID C204410
WBS 38454.3.1

FEDERAL-AID NO. 0070245
COUNTY WAKE
T.I.P NO. B-4654
MILES 0.396
ROUTE NO. NC-50
LOCATION BRIDGE #69 OVER US-70 ON NC-50 (BENSON RD).

TYPE OF WORK GRADING, DRAINAGE, PAVING, AND STRUCTURES.

NOTICE:

ALL BIDDERS SHALL COMPLY WITH ALL APPLICABLE LAWS REGULATING THE PRACTICE OF GENERAL CONTRACTING AS CONTAINED IN CHAPTER 87 OF THE GENERAL STATUTES OF NORTH CAROLINA WHICH REQUIRES THE BIDDER TO BE LICENSED BY THE N.C. LICENSING BOARD FOR CONTRACTORS WHEN BIDDING ON ANY NON-FEDERAL AID PROJECT WHERE THE BID IS \$30,000 OR MORE, EXCEPT FOR CERTAIN SPECIALTY WORK AS DETERMINED BY THE LICENSING BOARD. BIDDERS SHALL ALSO COMPLY WITH ALL OTHER APPLICABLE LAWS REGULATING THE PRACTICES OF ELECTRICAL, PLUMBING, HEATING AND AIR CONDITIONING AND REFRIGERATION CONTRACTING AS CONTAINED IN CHAPTER 87 OF THE GENERAL STATUTES OF NORTH CAROLINA. NOTWITHSTANDING THESE LIMITATIONS ON BIDDING, THE BIDDER WHO IS AWARDED ANY FEDERAL - AID FUNDED PROJECT SHALL COMPLY WITH CHAPTER 87 OF THE GENERAL STATUTES OF NORTH CAROLINA FOR LICENSING REQUIREMENTS WITHIN 60 CALENDAR DAYS OF BID OPENING.

BIDS WILL BE RECEIVED AS SHOWN BELOW:

THIS IS A ROADWAY & STRUCTURE PROPOSAL

5% BID BOND OR BID DEPOSIT REQUIRED

**PROPOSAL FOR THE CONSTRUCTION OF
CONTRACT No. C204410 IN WAKE COUNTY, NORTH CAROLINA
DEPARTMENT OF TRANSPORTATION,
RALEIGH, NORTH CAROLINA**

The Bidder has carefully examined the location of the proposed work to be known as Contract No. **C204410** has carefully examined the plans and specifications, which are acknowledged to be part of the proposal, the special provisions, the proposal, the form of contract, and the forms of contract payment bond and contract performance bond; and thoroughly understands the stipulations, requirements and provisions. The undersigned bidder agrees to bound upon his execution of the bid and subsequent award to him by the Board of Transportation in accordance with this proposal to provide the necessary contract payment bond and contract performance bond within fourteen days after the written notice of award is received by him. The undersigned Bidder further agrees to provide all necessary machinery, tools, labor, and other means of construction; and to do all the work and to furnish all materials, except as otherwise noted, necessary to perform and complete the said contract in accordance with the *2024 Standard Specifications for Roads and Structures* by the dates(s) specified in the Project Special Provisions and in accordance with the requirements of the Engineer, and at the unit or lump sum prices, as the case may be, for the various items given on the sheets contained herein.

The Bidder shall provide and furnish all the materials, machinery, implements, appliances and tools, and perform the work and required labor to construct and complete Contract No. **C204410** in **Wake County**, for the unit or lump sum prices, as the case may be, bid by the Bidder in his bid and according to the proposal, plans, and specifications prepared by said Department, which proposal, plans, and specifications show the details covering this project, and hereby become a part of this contract.

The published volume entitled *North Carolina Department of Transportation, Raleigh, Standard Specifications for Roads and Structures, January 2024* with all amendments and supplements thereto, is by reference incorporated into and made a part of this contract; that, except as herein modified, all the construction and work included in this contract is to be done in accordance with the specifications contained in said volume, and amendments and supplements thereto, under the direction of the Engineer.

If the proposal is accepted and the award is made, the contract is valid only when signed either by the Contract Officer or such other person as may be designated by the Secretary to sign for the Department of Transportation. The conditions and provisions herein cannot be changed except over the signature of the said Contract Officer.

The quantities shown in the itemized proposal for the project are considered to be approximate only and are given as the basis for comparison of bids. The Department of Transportation may increase or decrease the quantity of any item or portion of the work as may be deemed necessary or expedient.

An increase or decrease in the quantity of an item will not be regarded as sufficient ground for an increase or decrease in the unit prices, nor in the time allowed for the completion of the work, except as provided for the contract.

Accompanying this bid is a bid bond secured by a corporate surety, or certified check payable to the order of the Department of Transportation, for five percent of the total bid price, which deposit is to be forfeited as liquidated damages in case this bid is accepted and the Bidder shall fail to provide the required payment and performance bonds with the Department of Transportation, under the condition of this proposal, within 14 calendar days after the written notice of award is received by him, as provided in the *Standard Specifications*; otherwise said deposit will be returned to the Bidder.



State Contract Officer

DocuSigned by:

Ronald Elton Davenport, Jr.

52C46046381F443...

03/13/2024

TABLE OF CONTENTS

**COVER SHEET
PROPOSAL SHEET**

PROJECT SPECIAL PROVISIONS

BUILD AMERICA, BUY AMERICA (BABA): G-1
 CONTRACT TIME AND LIQUIDATED DAMAGES: G-1
 INTERMEDIATE CONTRACT TIME NUMBER 1 AND LIQUIDATED DAMAGES: G-2
 INTERMEDIATE CONTRACT TIME NUMBER 2 AND LIQUIDATED DAMAGES: G-2
 INTERMEDIATE CONTRACT TIME NUMBER 3 AND LIQUIDATED DAMAGES: G-3
 INTERMEDIATE CONTRACT TIME NUMBER 4 AND LIQUIDATED DAMAGES: G-4
 INTERMEDIATE CONTRACT TIME NUMBER 5 AND LIQUIDATED DAMAGES: G-4
 INTERMEDIATE CONTRACT TIME NUMBER 6 AND LIQUIDATED DAMAGES: G-4
 INTERMEDIATE CONTRACT TIME NUMBER 7 AND LIQUIDATED DAMAGES: G-5
 PERMANENT VEGETATION ESTABLISHMENT:..... G-5
 MAJOR CONTRACT ITEMS: G-6
 SPECIALTY ITEMS:..... G-6
 FUEL PRICE ADJUSTMENT:..... G-6
 STEEL PRICE ADJUSTMENT:..... G-8
 SCHEDULE OF ESTIMATED COMPLETION PROGRESS:..... G-19
 DISADVANTAGED BUSINESS ENTERPRISE: G-19
 CERTIFICATION FOR FEDERAL-AID CONTRACTS: G-33
 RESTRICTIONS ON ITS EQUIPMENT AND SERVICES:..... G-34
 USE OF UNMANNED AIRCRAFT SYSTEM (UAS): G-34
 EQUIPMENT IDLING GUIDELINES:..... G-34
 U.S. DEPARTMENT OF TRANSPORTATION HOTLINE: G-35
 SUBSURFACE INFORMATION:..... G-35
 PORTABLE CONCRETE BARRIER - (Partial Payments for Materials):..... G-35
 TWELVE MONTH GUARANTEE:..... G-36
 EROSION AND SEDIMENT CONTROL/STORMWATER CERTIFICATION: G-36
 PROCEDURE FOR MONITORING BORROW PIT DISCHARGE:..... G-42

 ROADWAYR-1

STANDARD SPECIAL PROVISIONS

AVAILABILITY OF FUNDS – TERMINATION OF CONTRACTSSSP-1
 NCDOT GENERAL SEED SPECIFICATION FOR SEED QUALITYSSP-2
 ERRATA.....SSP-5
 PLANT AND PEST QUARANTINESSSP-6
 TITLE VI AND NONDISCRIMINATION:SSP-7
 MINORITY AND FEMALE EMPLOYMENT REQUIREMENTSSSP-16
 REQUIRED CONTRACT PROVISIONS FEDERAL-AID CONSTR CONTRACTSSSP-19
 ON-THE-JOB TRAININGSSP-33
 MINIMUM WAGESSSP-36

UNIT PROJECT SPECIAL PROVISIONS

GEOTECHNICAL.....GT-0.1
GEOENVIRONMENTAL..... GV-1
LIGHTING ECS-1
UTILITY CONSTRUCTION.....UC-1
UTILITY BY OTHERS..... UBO-1
EROSION CONTROL EC-1
TRAFFIC SIGNALSTS-1
STRUCTURE/CULVERTSST-1

PERMITS P-1

PROPOSAL ITEM SHEET

ITEM SHEET(S)

PROJECT SPECIAL PROVISIONS**GENERAL****BUILD AMERICA, BUY AMERICA (BABA):**

(11-15-22)(Rev. 1-16-24)

106

SP1 G04

Revise the *Standard Specifications* as follows:

Page 1-48, Article 106-1 GENERAL REQUIREMENTS, add the following after line 49:

(C) Build America, Buy America (BABA)

All manufactured products and construction materials permanently incorporated into any project must meet requirements of the Build America, Buy America (BABA) Act of the Infrastructure Investment and Jobs Act (IIJA). Before any material or product shown on the Department's Build America, Buy America (BABA) List is included for payment on a monthly estimate, the Contractor shall furnish the Engineer with a notarized certification certifying that the items conform to the BABA Act. The Department's Build America Buy America (BABA) List can be found on the Department's website.

<https://connect.ncdot.gov/letting/LetCentral/NCDOT%20BABA%20Materials%20List.pdf>

Each purchase order issued by the Contractor or a subcontractor for items on the BABA List to be permanently incorporated into any project shall contain in bold print a statement advising the supplier that the manufactured products and construction materials must be produced in the United States of America. The Contractor and all affected subcontractors shall maintain a separate file for BABA List items so that verification of the Contractor's efforts to purchase items produced in the United States can readily be verified by an authorized representative of the Department or the Federal Highway Administration (FHWA).

CONTRACT TIME AND LIQUIDATED DAMAGES:

(8-15-00) (Rev. 5-16-23)

108

SP1 G08 A

The date of availability for this contract is **May 29, 2024**, except that work in jurisdictional waters and wetlands shall not begin until a meeting between the DOT, Regulatory Agencies, and the Contractor is held as stipulated in the permits contained elsewhere in this proposal. This delay in availability has been considered in determining the contract time for this project.

The completion date for this contract is **March 30, 2027**.

Except where otherwise provided by the contract, observation periods required by the contract will not be a part of the work to be completed by the completion date and/or intermediate contract times stated in the contract. The acceptable completion of the observation periods that extend beyond the final completion date shall be a part of the work covered by the performance and payment bonds.

The liquidated damages for this contract are **Two Hundred Dollars (\$ 200.00)** per calendar day. These liquidated damages will not be cumulative with any liquidated damages which may become chargeable under Intermediate Contract Time Number 1.

INTERMEDIATE CONTRACT TIME NUMBER 1 AND LIQUIDATED DAMAGES:

(7-1-95) (Rev. 2-21-12)

108

SP1 G13 A

Except for that work required under the Project Special Provisions entitled *Planting, Reforestation* and/or *Permanent Vegetation Establishment*, included elsewhere in this proposal, the Contractor will be required to complete all work included in this contract and shall place and maintain traffic on same.

The date of availability for this intermediate contract time is **May 29, 2024**.

The completion date for this intermediate contract time is **October 1, 2026**.

The liquidated damages for this intermediate contract time are **Two Thousand Dollars (\$ 2,000.00)** per calendar day.

Upon apparent completion of all the work required to be completed by this intermediate date, a final inspection will be held in accordance with Article 105-17 and upon acceptance, the Department will assume responsibility for the maintenance of all work except *Planting, Reforestation* and/or *Permanent Vegetation Establishment*. The Contractor will be responsible for and shall make corrections of all damages to the completed roadway caused by his planting operations, whether occurring prior to or after placing traffic through the project.

INTERMEDIATE CONTRACT TIME NUMBER 2 AND LIQUIDATED DAMAGES:

(2-20-07)

108

SP1 G14 A

The Contractor shall complete the required work of installing, maintaining, and removing the traffic control devices for lane closures and restoring traffic to the existing traffic pattern. The Contractor shall not close or narrow a lane of traffic on **NC 50, US 70 and/or Any Other Road** during the following time restrictions:

DAY AND TIME RESTRICTIONS

**Monday thru Friday
6:00 a.m. to 9:00 a.m. & 3:00 p.m. to 6:00 p.m.**

In addition, the Contractor shall not narrow or close a lane of traffic on **NC 50, US 70 and/or Any Other Road**, detain and /or alter the traffic flow on or during holiday weekends, special events, or any other time when traffic is unusually heavy, including the following schedules:

HOLIDAY AND HOLIDAY WEEKEND LANE CLOSURE RESTRICTIONS

1. For **unexpected occurrence** that creates unusually high traffic volumes, as directed by the Engineer.

2. For **New Year's Day**, between the hours of **6:00 a.m.** December 31st and **6:00 p.m.** January 2nd. If New Year's Day is on a Friday, Saturday, Sunday or Monday, then until **6:00 p.m.** the following Tuesday.
3. For **Easter**, between the hours of **6:00 a.m.** Thursday and **6:00 p.m.** Monday.
4. For **Memorial Day**, between the hours of **6:00 a.m.** Friday and **6:00 p.m.** Tuesday.
5. For **Independence Day**, between the hours of **6:00 a.m.** the day before Independence Day and **6:00 p.m.** the day after Independence Day.

If **Independence Day** is on a Friday, Saturday, Sunday or Monday, then between the hours of **6:00 a.m.** the Thursday before Independence Day and **6:00 p.m.** the Tuesday after Independence Day.
6. For **Labor Day**, between the hours of **6:00 a.m.** Friday and **6:00 p.m.** Tuesday.
7. For **Thanksgiving**, between the hours of **6:00 a.m.** Tuesday and **6:00 p.m.** Monday.
8. For **Christmas**, between the hours of **6:00 a.m.** the Friday before the week of Christmas Day and **6:00 p.m.** the following Tuesday after the week of Christmas Day.

The time of availability for this intermediate contract work shall be the time the Contractor begins to install all traffic control devices for lane closures according to the time restrictions listed herein.

The completion time for this intermediate contract work shall be the time the Contractor is required to complete the removal of all traffic control devices for lane closures according to the time restrictions stated herein and place traffic in the existing traffic pattern.

The liquidated damages are **Two Hundred Fifty Dollars (\$ 250.00)** per fifteen (15) minute time period.

INTERMEDIATE CONTRACT TIME NUMBER 3 AND LIQUIDATED DAMAGES:

(2-20-07)

108

SPI G14 D

The Contractor shall complete the required work of installing, maintaining and removing the traffic control devices for road closures and restoring traffic to the existing traffic pattern. The Contractor shall not close **US 70** during the following time restrictions:

DAY AND TIME RESTRICTIONS

**Monday thru Sunday
6:00 a.m. to 10:00 p.m.**

The time of availability for this intermediate contract time will be the time the Contractor begins to install traffic control devices required for road closures according to the time restrictions stated herein.

The completion time for this intermediate contract time will be the time the Contractor is required to complete the removal of traffic control devices required for the road closures according to the time restrictions stated herein and restore traffic to the existing traffic pattern

The liquidated damages are **Two Thousand Five Hundred Dollars (\$ 2,500.00)** per fifteen (15) minute time period.

INTERMEDIATE CONTRACT TIME NUMBER 4 AND LIQUIDATED DAMAGES:

(2-20-07) (Rev. 6-18-13)

108

SPI G14 H

The Contractor shall complete the work required of **Phase I, Step #8** as shown on Sheet **TMP-03** and shall place and maintain traffic on same.

The date of availability for this intermediate contract time is the date the Contractor elects to begin the work.

The completion date for this intermediate contract time is the date which is **ten (10)** consecutive calendar days after and including the date the Contractor begins this work.

The liquidated damages are **Two Hundred Fifty Dollars (\$ 250.00)** per calendar day.

INTERMEDIATE CONTRACT TIME NUMBER 5 AND LIQUIDATED DAMAGES:

(2-20-07) (Rev. 6-18-13)

108

SPI G14 H

The Contractor shall complete the work required of **Phase II, Steps #3 & #4** as shown on Sheet **TMP-03** and shall place and maintain traffic on same.

The date of availability for this intermediate contract time is the date the Contractor elects to begin the work.

The completion date for this intermediate contract time is the date which is **sixty (60)** consecutive calendar days after and including the date the Contractor begins this work.

The liquidated damages are **Four Thousand Dollars (\$ 4,000.00)** per calendar day.

INTERMEDIATE CONTRACT TIME NUMBER 6 AND LIQUIDATED DAMAGES:

(2-20-07) (Rev. 6-18-13)

108

SPI G14 H

The Contractor shall complete the work required of **Phase II, Step #6** as shown on Sheet **TMP-3** and shall place and maintain traffic on same.

The date of availability for this intermediate contract time is the date the Contractor elects to begin the work.

The completion date for this intermediate contract time is the date which is **twenty-one (21)** consecutive calendar days after and including the date the Contractor begins this work.

The liquidated damages are **Five Thousand Dollars (\$ 5,000.00)** per calendar day.

INTERMEDIATE CONTRACT TIME NUMBER 7 AND LIQUIDATED DAMAGES:

(2-20-07)(Rev. 6-18-13)

108

SP1 G14 H

The Contractor shall complete the work required of **Phase III, Step #3** as shown on Sheet **TMP-03A** and shall place and maintain traffic on same.

The date of availability for this intermediate contract time is the date the Contractor elects to begin the work.

The completion date for this intermediate contract time is the date which is **fourteen (14)** consecutive calendar days after and including the date the Contractor begins this work.

The liquidated damages are **Two Thousand Dollars (\$ 2,000.00)** per calendar day.

PERMANENT VEGETATION ESTABLISHMENT:

(2-16-12)(Rev. 1-16-24)

104

SP1 G16

Establish a permanent stand of the vegetation mixture shown in the contract. During the period between initial vegetation planting and final project acceptance, perform all work necessary to establish permanent vegetation on all erodible areas within the project limits, as well as, in borrow and waste pits. This work shall include erosion control device maintenance and installation, repair seeding and mulching, supplemental seeding and mulching, mowing, and fertilizer topdressing, as directed. All work shall be performed in accordance with the applicable section of the *Standard Specifications*. All work required for initial vegetation planting shall be performed as a part of the work necessary for the completion and acceptance of the Intermediate Contract Time (ICT). Between the time of ICT and Final Project acceptance, or otherwise referred to as the vegetation establishment period, the Department will be responsible for preparing the required National Pollutant Discharge Elimination System (NPDES) inspection records.

Once the Engineer has determined that the permanent vegetation establishment requirement has been achieved at an 80% vegetation density (the amount of established vegetation per given area to stabilize the soil) and no erodible areas exist within the project limits, the Contractor will be notified to remove the remaining erosion control devices that are no longer needed. The Contractor will be responsible for, and shall correct any areas disturbed by operations performed in permanent vegetation establishment and the removal of temporary erosion control measures, whether occurring prior to or after placing traffic on the project.

Payment for *Response for Erosion Control, Seeding and Mulching, Repair Seeding, Supplemental Seeding, Mowing, Fertilizer Topdressing, Silt Excavation, and Stone for Erosion Control* will be made at contract unit prices for the affected items. Work required that is not represented by contract line items will be paid in accordance with Articles 104-7 or 104-3 of the *Standard Specifications*. No additional compensation will be made for maintenance and removal of temporary erosion control items.

MAJOR CONTRACT ITEMS:

(2-19-02)(Rev. 1-16-24)

104

SP1 G28

The following listed items are the major contract items for this contract (see Article 104-5 of the *Standard Specifications*):

Line #	Description
8	Temporary Shoring
227	MSE Retaining Wall No W2
233	Reinforced Concrete Deck Slab
235	Class A Concrete (Bridge)
239	54" Prestressed Concrete Girders

SPECIALTY ITEMS:

(7-1-95)(Rev. 1-16-24)

108-6

SP1 G37

Items listed below will be the specialty items for this contract (see Article 108-6 of the *Standard Specifications*).

Line #	Description
66-72	Guardrail
73-74	Fencing
77-85	Signing
103-106, 112-115	Long-Life Pavement Markings
107	Removable Tape
117-118	Permanent Pavement Markers
119-122, 124	Lighting
125-153	Utility Construction
154-185	Erosion Control
186-225	Signals/ITS System

FUEL PRICE ADJUSTMENT:

(11-15-05)(Rev. 1-16-24)

109-8

SP1 G43

Page 1-82, Article 109-8, FUEL PRICE ADJUSTMENTS, add the following:

The base index price for DIESEL #2 FUEL is \$ **2.7781** per gallon. Where any of the following are included as pay items in the contract, they will be eligible for fuel price adjustment.

The pay items and the fuel factor used in calculating adjustments to be made will be as follows:

Description	Units	Fuel Usage Factor Diesel
Unclassified Excavation	Gal/CY	0.29
Borrow Excavation	Gal/CY	0.29
Class IV Subgrade Stabilization	Gal/Ton	0.55
Aggregate Base Course	Gal/Ton	0.55
Sub-Ballast	Gal/Ton	0.55
Erosion Control Stone	Gal/Ton	0.55
Rip Rap, Class _____	Gal/Ton	0.55
Asphalt Concrete Base Course, Type _____	Gal/Ton	0.90 or 2.90
Asphalt Concrete Intermediate Course, Type _____	Gal/Ton	0.90 or 2.90
Asphalt Concrete Surface Course, Type _____	Gal/Ton	0.90 or 2.90
Open-Graded Asphalt Friction Course	Gal/Ton	0.90 or 2.90
Permeable Asphalt Drainage Course, Type _____	Gal/Ton	0.90 or 2.90
Sand Asphalt Surface Course, Type _____	Gal/Ton	0.90 or 2.90
Ultra-thin Bonded Wearing Course	Gal/Ton	0.90 or 2.90
Aggregate for Cement Treated Base Course	Gal/Ton	0.55
Portland Cement for Cement Treated Base Course	Gal/Ton	0.55
> 11" Portland Cement Concrete Pavement	Gal/SY	0.327
Concrete Shoulders Adjacent to > 11" Pavement	Gal/SY	0.327
9" to 11" Portland Cement Concrete Pavement	Gal/SY	0.272
Concrete Shoulders Adjacent to 9" to 11" Pavement	Gal/SY	0.272
< 9" Portland Cement Concrete Pavement	Gal/SY	0.245
Concrete Shoulders Adjacent to < 9" Pavement	Gal/SY	0.245

For the asphalt items noted in the chart as eligible for fuel adjustments, the bidder may include the *Fuel Usage Factor Adjustment Form* with their bid submission if they elect to use the fuel usage factor. The *Fuel Usage Factor Adjustment Form* is found at the following link:

<https://connect.ncdot.gov/letting/LetCentral/Fuel%20Usage%20Factor%20Adjustment%20Form%20-%20Starting%20Nov%202022%20Lettings.pdf>

Select either 2.90 Gal/Ton fuel factor or 0.90 Gal/Ton fuel factor for each asphalt line item on the *Fuel Usage Factor Adjustment Form*. The selected fuel factor for each asphalt item will remain in effect for the duration of the contract.

Failure to complete the *Fuel Usage Factor Adjustment Form* will result in using 2.90 gallons per ton as the Fuel Usage Factor for Diesel for the asphalt items noted above. The contractor will not be permitted to change the Fuel Usage Factor after the bids are submitted.

STEEL PRICE ADJUSTMENT:

(4-19-22)(Rev. 12-20-22)

SP1 G47

Description and Purpose

Steel price adjustments will be made to the payments due the Contractor for items as defined herein that are permanently incorporated into the work, when the price of raw steel mill products utilized on the contract have fluctuated. The Department will adjust monthly progress payments up or down as appropriate for cost changes in steel according to this provision.

Eligible Items

The list of eligible bid items for steel price adjustment can be found on the Departments website at the following address:

<https://connect.ncdot.gov/letting/LetCentral/Eligible%20Bid%20Items%20for%20Steel%20Price%20Adjustment.xlsx>

Nuts, bolts, anchor bolts, rebar chairs, connecting bands and other miscellaneous hardware associated with these items shall not be included in the price adjustment.

Adjustments will only be made for fluctuations in the material cost of the steel used in the above products as specified in the Product Relationship Table below. The producing mill is defined as the source of steel product before any fabrication has occurred (e.g., coil, plate, rebar, hot rolled shapes, etc.). No adjustment will be made for changes in the cost of fabrication, coating, shipping, storage, etc.

No steel price adjustments will be made for any products manufactured from steel having an adjustment date, as defined by the Product Relationship Table below, prior to the letting date.

Bid Submittal Requirements

The successful bidder, within 14 calendar days after the notice of award is received by him, shall provide the completed Form SPA-1 to the Department (State Contract Officer or Division Contract Engineer) along with the payment bonds, performance bonds and contract execution signature sheets in a single submittal. If Form SPA-1 is not included in the same submittal as the payment bonds, performance bonds and contract execution signature sheets, the Contractor will not be eligible for any steel price adjustment for any item in the contract for the life of the contract. Form SPA-1 can be found on the Department's website at the following address:

<https://connect.ncdot.gov/letting/LetCentral/Form%20SPA-1.xlsm>

The Contractor shall provide Form SPA-1 listing the Contract Line Number, (with corresponding Item Number, Item Description, and Category) for the steel products they wish to have an adjustment calculated. Only the contract items corresponding to the list of eligible item numbers for steel price adjustment may be entered on Form SPA-1. The Contractor may choose to have steel price adjustment applied to any, all, or none of the eligible items. However, the Contractor's selection of items for steel price adjustment or non-selection (non-participation)

may not be changed once Form SPA-1 has been received by the Department. Items the Bidder chooses for steel price adjustment must be designated by writing the word “Yes” in the column titled “Option” by each Pay Item chosen for adjustment. Should the bidder elect an eligible steel price item, the entire quantity of the line item will be subject to the price adjustment for the duration of the Contract. The Bidder’s designations on Form SPA-1 must be written in ink or typed and signed by the Bidder (Prime Contractor) to be considered complete. Items not properly designated, designated with “No”, or left blank on the Bidder’s Form SPA-1 will automatically be removed from consideration for adjustment. No steel items will be eligible for steel price adjustment on this Project if the Bidder fails to return Form SPA-1 in accordance with this provision.

Establishing the Base Price

The Department will use a blend of monthly average prices as reported from the Fastmarkets platform to calculate the monthly adjustment indices (BI and MI). This data is typically available on the first day of the month for the preceding month. The indices will be calculated by the Department for the different categories found on the Product Relationship Table below. For item numbers that include multiple types of steel products, the category listed for that item number will be used for adjusting each steel component.

- The bidding index for Category 1 Steel items is **\$ 42.56** per hundredweight.
- The bidding index for Category 2 Steel items is **\$ 63.5** per hundredweight.
- The bidding index for Category 3 Steel items is **\$ 64.78** per hundredweight.
- The bidding index for Category 4 Steel items is **\$ 48.06** per hundredweight.
- The bidding index for Category 5 Steel items is **\$ 56.56** per hundredweight.
- The bidding index for Category 6 Steel items is **\$ 66.8** per hundredweight.
- The bidding index for Category 7 Steel items is **\$ 44.34** per hundredweight.

The bidding index represents a selling price of steel based on Fastmarkets data for the month of **February 2024**.

- MI = Monthly Index. – in Dollars (\$) per hundredweight (CWT). Use the adjustment indices from the month the steel was shipped from the producing mill, received on the project, or member cast as defined in the Product Relationship Table.
- BI = Bidding Index. - in Dollars (\$) per hundredweight (CWT). Use the adjustment indices as listed in the proposal.

<i>Product Relationship Table</i>			
<i>Steel Product (Title)</i>	BI, MI*	Adjustment Date for MI	Category
Reinforcing Steel, Bridge Deck, and SIP Forms	Based on one or more Fastmarkets indices	Delivery Date from Producing Mill	1
Structural Steel and Encasement Pipe	Based on one or more Fastmarkets indices	Delivery Date from Producing Mill	2
Steel H-Piles, Soldier Pile Walls	Based on one or more Fastmarkets indices	Delivery Date from Producing Mill	3
Guardrail Items and Pipe	Based on one or more	Material Received Date**	4

Piles	Fastmarkets indices		
Fence Items	Based on one or more Fastmarkets indices	Material Received Date**	5
Overhead Sign Assembly, Signal Poles, High Mount Standards	Based on one or more Fastmarkets indices	Material Received Date**	6
Prestressed Concrete Members	Based on one or more Fastmarkets indices	Cast Date of Member	7
* BI and MI are in converted units of Dollars per Hundredweight (\$/CWT)			
** Material Received Date is defined as the date the materials are received on the project site. If a material prepayment is made for a Category 4-6 item, the Adjustment Date to be used will be the date of the prepayment request instead of the Materials Received Date.			

Submit documentation to the Engineer for all items listed in the Contract for which the Contractor is requesting a steel price adjustment.

Submittal Requirements

The items in categories 1,2, and 3, shall be specifically stored, labeled, or tagged, recognizable by color marking, and identifiable by Project for inspection and audit verification immediately upon arrival at the fabricator.

Furnish the following documentation for all steel products to be incorporated into the work and documented on Form SPA-2, found on the Departments website at the following address:

<https://connect.ncdot.gov/projects/construction/Construction%20Forms/Form%20SPA-2.xlsx>

Submit all documentation to the Engineer prior to incorporation of the steel into the completed work. The Department will withhold progress payments for the affected contract line item if the documentation is not provided and at the discretion of the Engineer the work is allowed to proceed. Progress payments will be made upon receipt of the delinquent documentation.

Step 1 (Form SPA -2)

Utilizing Form SPA-2, submit separate documentation packages for each line item from Form SPA-1 for which the Contractor opted for a steel price adjustment. For line items with multiple components of steel, each component should be listed separately. Label each SPA-2 documentation package with a unique number as described below.

- a. Documentation package number: (Insert the contract line-item) - (Insert sequential package number beginning with "1").

Example: 412 - 1,
412 - 2,
424 - 1,
424 - 2,
424 - 3, etc.

- b. The steel product quantity in pounds

- i. The following sources should be used, in declining order of precedence, to determine the weight of steel/iron, based on the Engineer's decision:
 1. Department established weights of steel/iron by contract pay item per pay unit;
 2. Approved Shop Drawings;
 3. Verified Shipping Documents;
 4. Contract Plans;
 5. Standard Drawing Sheets;
 6. Industry Standards (i.e., AISC Manual of Steel Construction, AWWA Standards, etc.); and
 7. Manufacturer's data.
- ii. Any item requiring approved shop drawings shall have the weights of steel calculated and shown on the shop drawings or submitted and certified separately by the fabricator.
- c. The date the steel product, subject to adjustment, was shipped from the producing mill (Categories 1-3), received on the project (Categories 4-6), or casting date (Category 7).

Step 2 (Monthly Calculator Spreadsheet)

For each month, upon the incorporation of the steel product into the work, provide the Engineer the following:

- 1) Completed NCDOT Steel Price Adjustment Calculator Spreadsheet, summarizing all the steel submittal packages (Form SPA-2) actually incorporated into the completed work in the given month.
 - a. Contract Number
 - b. Bidding Index Reference Month
 - c. Contract Completion Date or Revised Completion Date
 - d. County, Route, and Project TIP information
 - e. Item Number
 - f. Line-Item Description
 - g. Submittal Number from Form SPA-2
 - h. Adjustment date
 - i. Pounds of Steel
- 2) An affidavit signed by the Contractor stating the documentation provided in the NCDOT Steel Price Adjustment Calculator Spreadsheet is true and accurate.

Price Adjustment Conditions

Download the Monthly Steel Adjustment Spreadsheet with the most current reference data from the Department's website each month at the following address:

<https://connect.ncdot.gov/projects/construction/Construction%20Forms/Form%20SPA-3%20NCDOT%20Steel%20Price%20Adjustment%20Calculator.xlsx>

If the monthly Fastmarkets data is not available, the data for the most recent immediately preceding month will be used as the basis for adjustment.

Price Adjustment Calculations

The price adjustment will be determined by comparing the percentage of change in index value listed in the proposal (BI) to the monthly index value (MI). (See included sample examples). Weights and date of shipment must be documented as required herein. The final price adjustment dollar value will be determined by multiplying this percentage increase or decrease in the index by the represented quantity of steel incorporated into the work, and the established bidding index (BI) subject to the limitations herein.

Price increase/decrease will be computed as follows:

$$\text{SPA} = ((\text{MI} / \text{BI}) - 1) * \text{BI} * (\text{Q} / 100)$$

Where;

SPA = Steel price adjustment in dollars

MI = Monthly Shipping Index. – in Dollars (\$) per hundredweight (CWT). Use the adjustment indices from the month the steel was shipped from the producing mill, received on the project, or member cast as defined in the Product Relationship Table.

BI = Bidding Index. - in Dollars (\$) per hundredweight (CWT). Use the adjustment indices as listed in the proposal.

Q = Quantity of steel, product, pounds actually incorporated into the work as documented by the Contractor, or Design Build Team and verified by the Engineer.

Calculations for price adjustment shall be shown separate from the monthly progress estimate and will not be included in the total cost of work for determination of progress or for extension of Contract time in accordance with Subarticle 108-10(B)(1).

Any apparent attempt to unbalance bids in favor of items subject to price adjustment may result in rejection of the bid proposal.

Adjustments will be paid or charged to the Contractor only. Any Contractor receiving an adjustment under this provision shall distribute the proper proportional part of such adjustments to the subcontractor who performed the applicable work.

Delays to the work caused by steel shortages may be justification for a Contract time extension but will not constitute grounds for claims for standby equipment, extended office overhead, or other costs associated with such delays.

If an increase in the steel material price is anticipated to exceed 50% of the original quoted price, the contractor must notify the Department within 7 days prior to purchasing the material. Upon receipt of such notification, the Department will direct the Contractor to either (1) proceed with the work or (2) suspend the work and explore the use of alternate options.

If the decrease in the steel material exceeds 50% of the original quoted price, the contractor may submit to the Department additional market index information specific to the item in question to dispute the decrease. The Department will review this information and determine if the decrease is warranted.

When the steel product adjustment date, as defined in the Product Relationship Table, is after the approved contract completion date, the steel price adjustments will be based on the lesser value of either the MI for the month of the approved contract completion date or the MI for the actual adjustment date.

If the price adjustment is based on estimated material quantities for that time, and a revision to the total material quantity is made in a subsequent or final estimate, an appropriate adjustment will be made to the price adjustment previously calculated. The adjustment will be based on the same indices used to calculate the price adjustment which is being revised. If the adjustment date of the revised material quantity cannot be determined, the adjustment for the quantity in question, will be based on the indices utilized to calculate the steel price adjustment for the last initial documentation package submission, for the steel product subject to adjustment, that was incorporated into the particular item of work, for which quantities are being finalized.

Example: Structural steel for a particular bridge was provided for in three different shipments with each having a different mill shipping date. The quantity of structural steel actually used for the bridge was calculated and a steel price adjustment was made in a progress payment. At the conclusion of the work an error was found in the plans of the final quantity of structural steel used for the bridge. The quantity to be adjusted cannot be directly related to any one of the three mill shipping dates. The steel price adjustment for the quantity in question would be calculated using the indices that were utilized to calculate the steel price adjustment for the quantity of structural steel represented by the last initial structural steel documentation package submission. The package used will be the one with the greatest sequential number.

Extra Work/Force Account:

When steel products, as specified herein, are added to the contract as extra work, in accordance with the provisions of Article 104-7 or 104-3, the Engineer will determine and specify in the supplemental agreement, the need for application of steel price adjustments on a case-by-case basis. No steel price adjustments will be made for any products manufactured from steel having an adjustment date prior to the supplemental agreement execution date. Price adjustments will be made as provided herein, except the Bidding Index will be based on the month in which the supplemental agreement pricing was executed.

For work performed on force account basis, reimbursement of actual material costs, along with the specified overhead and profit markup, will be considered to include full compensation for the current cost of steel and no steel price adjustments will be made.

Examples Form SPA-2

Steel Price Adjustment Submission Form

Contract Number C203394 Bid Reference Month January 2019

Submittal Date 8/31/2019

Contract Line Item 237

Line Item Description APPROX....LBS Structural Steel

Sequential Submittal Number 2

Supplier	Description of material	Location information	Quantity in lbs.	Adjustment Date
XYZ mill	Structural Steel	Structure 3, Spans A-C	1,200,000	May 4, 2020
ABC distributing	Various channel & angle shapes	Structure 3 Spans A-C	35,000	July 14, 2020
		Total Pounds of Steel	1,235,000	

- Note: Attach the following supporting documentation to this form.
- Bill of Lading to support the shipping dates
 - Supporting information for weight documentation (e.g., Pay item reference, Shop drawings, shipping documents, Standards Sheets, industry standards, or manufacturer's data)

By providing this data under my signature, I attest to the accuracy of and validity of the data on this form and certify that no deliberate misrepresentation in any manner has occurred.

Printed Name _____

Signature _____

Examples Form SPA-2
Steel Price Adjustment Submission Form

Contract Number C203394 Bid Reference Month January 2019

Submittal Date August 31, 2019

Contract Line Item 237

Line Item Description SUPPORT, OVRHD SIGN STR -DFEB – STA 36+00

Sequential Submittal Number 2

Supplier	Description of material	Location information	Quantity in lbs.	Adjustment Date
XYZ mill	Tubular Steel (Vertical legs)	<u>-DFEB – STA 36+00</u>	12000	December 11, 2021
PDQ Mill	4” Tubular steel (Horizontal legs)	<u>-DFEB – STA 36+00</u>	5900	December 11, 2021
ABC distributing	Various channel & angle shapes (see quote)	<u>-DFEB – STA 36+00</u>	1300	December 11, 2021
	Catwalk assembly	<u>-DFEB – STA 36+00</u>	2000	December 11, 2021
Nucor	Flat plate	<u>-DFEB – STA 36+00</u>	650	December 11, 2021
		Total Pounds of Steel	21,850	

Note: Attach the following supporting documentation to this form.

- Bill of Lading to support the shipping dates
- Supporting information for weight documentation (e.g., Pay item reference, Shop drawings, shipping documents, Standards Sheets, industry standards, or manufacturer's data)

By providing this data under my signature, I attest to the accuracy of and validity of the data on this form and certify that no deliberate misrepresentation in any manner has occurred.

Printed Name

Signature

Price Adjustment Sample Calculation (increase)

Project bid on September 17, 2019

Line Item 635 "Structural Steel" has a plan quantity of 2,717,000 lbs.

Bidding Index for Structural Steel (Category 2) in the proposal was \$36.12/CWT = BI

450,000 lbs. of Structural Steel for Structure 2 at Station 44+08.60 were shipped to fabricator from the producing mill in same month, May 2021.

Monthly Index for Structural Steel (Category 2) for May 2021 was \$64.89/CWT = MI

The Steel Price Adjustment formula is as follows:

$$\text{SPA} = ((\text{MI} / \text{BI}) - 1) * \text{BI} * (\text{Q} / 100)$$

Where; SPA = Steel price adjustment in dollars

BI = Bidding Index – in dollars (\$) per hundredweight (CWT). Use the adjustment indices as listed in the proposal.

MI = Mill Shipping Index – in dollars (\$) per hundredweight (CWT). Use the adjustment indices from the month the steel was shipped from the producing mill, received on the project, or member cast as defined in the Product Relationship Table.

Q = Quantity of steel product, in pounds (lbs.) actually incorporated into the work as documented by the Contractor, or Design Build Team and verified by the Engineer.

$$\text{BI} = \$36.12 / \text{CWT}$$

$$\text{MI} = \$64.89 / \text{CWT}$$

$$\% \text{ change} = ((\text{MI} / \text{BI}) - 1) = (\$64.89 / \$36.12 - 1) = (1.79651 - 1) = 0.79651162791$$

$$\text{Q} = 450,000 \text{ lbs.}$$

$$\text{SPA} = 0.79651162791 \times \$36.12 \times (450,000 / 100)$$

$$\text{SPA} = 0.79651162791 * \$36.12 * 4,500$$

$$\text{SPA} = \$129,465 \text{ pay adjustment to Contractor for Structural Steel (Structure 2 at Station 44+08.60)}$$

Price Adjustment Sample Calculation (decrease)

Project bid on December 18, 2018

Line Item 635 Structural Steel has a plan quantity of 2,717,000 lbs.

Bidding Index for Structural Steel (Category 2) in the proposal was \$46.72/CWT = BI

600,000 lbs. of Structural Steel for Structure 1 at Station 22+57.68 were shipped to fabricator from the producing mill in same month, August 2020.

Monthly Index for Structural Steel (Category 2) for August 2020 was \$27.03/CWT = MI

The Steel Price Adjustment formula is as follows:

$$\text{SPA} = ((\text{MI} / \text{BI}) - 1) * \text{BI} * (\text{Q} / 100)$$

Where; SPA = Steel price adjustment in dollars

BI = Bidding Index – in dollars (\$) per hundredweight (CWT). Use the adjustment indices as listed in the proposal.

MI = Mill Shipping Index – in dollars (\$) per hundredweight (CWT). Use the adjustment indices from the month the steel was shipped from the producing mill, received on the project, or member cast as defined in the Product Relationship Table.

Q = Quantity of steel product, in pounds (lbs.) actually incorporated into the work as documented by the Contractor, or Design Build Team and verified by the Engineer.

$$\text{BI} = \$46.72 / \text{CWT}$$

$$\text{MI} = \$27.03 / \text{CWT}$$

$$\% \text{ change} = ((\text{MI} / \text{BI}) - 1) = (\$27.03 / \$46.72 - 1) = (0.57855 - 1) = -0.421446917808$$

$$\text{Q} = 600,000 \text{ lbs.}$$

$$\text{SPA} = -0.421446917808 * \$46.72 * (600,000 / 100)$$

$$\text{SPA} = -0.421446917808 * \$46.72 * 6,000$$

$$\text{SPA} = \$ 118,140.00 \text{ Credit to the Department for Structural Steel (Structure 1 at Station 22+57.68)}$$

Price Adjustment Sample Calculation (increase)

Project bid on July 16, 2020

Line Item 614 Reinforced Concrete Deck Slab has a plan quantity of 241974 lbs.

Bidding Index Reference Month was May 2020. Bidding Index for Reinforced Concrete Deck Slab (Category 1) in the proposal was \$29.21/CWT = BI

51,621 lbs. of reinforcing steel and 52,311 lbs. of epoxy coated reinforcing steel for Structure 2 at Station 107+45.55 -L- was shipped to fabricator from the producing mill in same month, May 2021.

Monthly Index for Reinforced Concrete Deck Slab (Category 1) for May 2021 was \$43.13/CWT = MI

The Steel Price Adjustment formula is as follows:

$$\text{SPA} = ((\text{MI} / \text{BI}) - 1) * \text{BI} * (\text{Q} / 100)$$

Where; SPA = Steel price adjustment in dollars

BI = Bidding Index – in dollars (\$) per hundredweight (CWT). Use the adjustment indices as listed in the proposal.

MI = Mill Shipping Index – in dollars (\$) per hundredweight (CWT). Use the adjustment indices from the month the steel was shipped from the producing mill, received on the project, or member cast as defined in the Product Relationship Table.

Q = Quantity of steel product, in pounds (lbs.) actually incorporated into the work as documented by the Contractor, or Design Build Team and verified by the Engineer.

$$\text{BI} = \$29.21 / \text{CWT}$$

$$\text{MI} = \$43.13 / \text{CWT}$$

$$\% \text{ change} = ((\text{MI} / \text{BI}) - 1) = (\$43.13 / \$29.21 - 1) = (1.47655 - 1) = 0.47654912701$$

$$\text{Q} = 103932 \text{ lbs.}$$

$$\text{SPA} = 0.47654912701 * \$29.21 * (103,932 / 100)$$

$$\text{SPA} = 0.47654912701 * \$29.21 * 1,039.32$$

SPA = \$14,467.33 Pay Adjustment to Contractor for Reinforced Concrete Deck Slab (Category 1) at Station 107+45.55 -L-

SCHEDULE OF ESTIMATED COMPLETION PROGRESS:

(7-15-08)(Rev. 1-16-24)

108-2

SP1 G58

The Contractor's attention is directed to the Standard Special Provision entitled *Availability of Funds Termination of Contracts* included elsewhere in this proposal. The Department of Transportation's schedule of estimated completion progress for this project as required by that Standard Special Provision is as follows:

	<u>Fiscal Year</u>	<u>Progress (% of Dollar Value)</u>
2024	(7/01/23 - 6/30/24)	4% of Total Amount Bid
2025	(7/01/24 - 6/30/25)	56% of Total Amount Bid
2026	(7/01/25 - 6/30/26)	35% of Total Amount Bid
2027	(7/01/26 - 6/30/27)	5% of Total Amount Bid

The Contractor shall also furnish his own progress schedule in accordance with Article 108-2 of the *Standard Specifications*. Any acceleration of the progress as shown by the Contractor's progress schedule over the progress as shown above shall be subject to the approval of the Engineer.

DISADVANTAGED BUSINESS ENTERPRISE:

(10-16-07)(Rev. 1-16-24)

102-15(J)

SP1 G61

Description

The purpose of this Special Provision is to carry out the U.S. Department of Transportation's policy of ensuring nondiscrimination in the award and administration of contracts financed in whole or in part with Federal funds. This provision is guided by 49 CFR Part 26.

Definitions

Additional DBE Subcontractors - Any DBE submitted at the time of bid that will not be used to meet the DBE goal. No submittal of a Letter of Intent is required.

Committed DBE Subcontractor - Any DBE submitted at the time of bid that is being used to meet the DBE goal by submission of a Letter of Intent. Or any DBE used as a replacement for a previously committed DBE firm.

Contract Goal Requirement - The approved DBE participation at time of award, but not greater than the advertised contract goal.

DBE Goal - A portion of the total contract, expressed as a percentage, that is to be performed by committed DBE subcontractor(s).

Disadvantaged Business Enterprise (DBE) - A firm certified as a Disadvantaged Business Enterprise through the North Carolina Unified Certification Program.

Goal Confirmation Letter - Written documentation from the Department to the bidder confirming the Contractor's approved, committed DBE participation along with a listing of the committed DBE firms.

Manufacturer - A firm that operates or maintains a factory or establishment that produces on the premises, the materials or supplies obtained by the Contractor.

Regular Dealer - A firm that owns, operates, or maintains a store, warehouse, or other establishment in which the materials or supplies required for the performance of the contract are bought, kept in stock, and regularly sold to the public in the usual course of business. A regular dealer engages in, as its principal business and in its own name, the purchase and sale or lease of the products in question. A regular dealer in such bulk items as steel, cement, gravel, stone, and petroleum products need not keep such products in stock, if it owns and operates distribution equipment for the products. Brokers and packagers are not regarded as manufacturers or regular dealers within the meaning of this section.

Replacement / Substitution – A full or partial reduction in the amount of work subcontracted to a committed (or an approved substitute) DBE firm.

North Carolina Unified Certification Program (NCUCP) - A program that provides comprehensive services and information to applicants for DBE certification, such that an applicant is required to apply only once for a DBE certification that will be honored by all recipients of USDOT funds in the state and not limited to the Department of Transportation only. The Certification Program is in accordance with 49 CFR Part 26.

United States Department of Transportation (USDOT) - Federal agency responsible for issuing regulations (49 CFR Part 26) and official guidance for the DBE program.

Forms and Websites Referenced in this Provision

DBE Payment Tracking System - On-line system in which the Contractor enters the payments made to DBE subcontractors who have performed work on the project.
<https://apps.dot.state.nc.us/Vendor/PaymentTracking/>

DBE-IS Subcontractor Payment Information - Form for reporting the payments made to all DBE firms working on the project. This form is for paper bid projects only.
<https://connect.ncdot.gov/business/Turnpike/Documents/Form%20DBE-IS%20Subcontractor%20Payment%20Information.pdf>

RF-1 DBE Replacement Request Form - Form for replacing a committed DBE.
<https://connect.ncdot.gov/projects/construction/Construction%20Forms/DBE%20MBE%20WBE%20Replacement%20Form%20and%20Instructions.pdf>

SAF Subcontract Approval Form - Form required for approval to sublet the contract.
<https://connect.ncdot.gov/projects/construction/Construction%20Forms/SAF%20Form%20-%20Subcontract%20Approval%20Form%20Revised%2004-19.xlsm>

JC-1 Joint Check Notification Form - Form and procedures for joint check notification. The form acts as a written joint check agreement among the parties providing full and prompt disclosure of the expected use of joint checks.

<http://connect.ncdot.gov/projects/construction/Construction%20Forms/Joint%20Check%20Notification%20Form.pdf>

Error! Hyperlink reference not valid.

Letter of Intent - Form signed by the Contractor and the DBE subcontractor, manufacturer or regular dealer that affirms that a portion of said contract is going to be performed by the signed DBE for the estimated amount (based on quantities and unit prices) listed at the time of bid.

<http://connect.ncdot.gov/letting/LetCentral/Letter%20of%20Intent%20to%20Perform%20as%20a%20Subcontractor.pdf>

Listing of DBE Subcontractors Form - Form for entering DBE subcontractors on a project that will meet this DBE goal. This form is for paper bids only.

[http://connect.ncdot.gov/municipalities/Bid%20Proposals%20for%20LGA%20Content/08%20DBE%20Subcontractors%20\(Federal\).docx](http://connect.ncdot.gov/municipalities/Bid%20Proposals%20for%20LGA%20Content/08%20DBE%20Subcontractors%20(Federal).docx)

Subcontractor Quote Comparison Sheet - Spreadsheet for showing all subcontractor quotes in the work areas where DBEs quoted on the project. This sheet is submitted with good faith effort packages.

<http://connect.ncdot.gov/business/SmallBusiness/Documents/DBE%20Subcontractor%20Quote%20Comparison%20Example.xls>

DBE Goal

The following DBE goal for participation by Disadvantaged Business Enterprises is established for this contract:

Disadvantaged Business Enterprises **3.0** %

- (A) *If the DBE goal is more than zero*, the Contractor shall exercise all necessary and reasonable steps to ensure that DBEs participate in at least the percent of the contract as set forth above as the DBE goal.
- (B) *If the DBE goal is zero*, the Contractor shall make an effort to recruit and use DBEs during the performance of the contract. Any DBE participation obtained shall be reported to the Department.

Directory of Transportation Firms (Directory)

Real-time information is available about firms doing business with the Department and firms that are certified through NCUCP in the Directory of Transportation Firms. Only firms identified in the Directory as DBE certified shall be used to meet the DBE goal. The Directory can be found at the following link. [https:// www.ebs.nc.gov/VendorDirectory/default.html](https://www.ebs.nc.gov/VendorDirectory/default.html)

The listing of an individual firm in the directory shall not be construed as an endorsement of the firm's capability to perform certain work.

Listing of DBE Subcontractors

At the time of bid, bidders shall submit all DBE participation that they anticipate to use during the life of the contract. Only those identified to meet the DBE goal will be considered committed, even though the listing shall include both committed DBE subcontractors and additional DBE subcontractors. Additional DBE subcontractor participation submitted at the time of bid will be used toward the Department's overall race-neutral goal. Only those firms with current DBE certification at the time of bid opening will be acceptable for listing in the bidder's submittal of DBE participation. The Contractor shall indicate the following required information:

(A) Electronic Bids

Bidders shall submit a listing of DBE participation in the appropriate section of the electronic submittal file.

- (1) Submit the names and addresses of DBE firms identified to participate in the contract. If the bidder uses the updated listing of DBE firms shown in the electronic submittal file, the bidder may use the dropdown menu to access the name and address of the DBE firm.
- (2) Submit the contract line numbers of work to be performed by each DBE firm. When no figures or firms are entered, the bidder will be considered to have no DBE participation.
- (3) The bidder shall be responsible for ensuring that the DBE is certified at the time of bid by checking the Directory of Transportation Firms. If the firm is not certified at the time of the bid-letting, that DBE's participation will not count towards achieving the DBE goal.

(B) Paper Bids

- (1) *If the DBE goal is more than zero,*
 - (a) Bidders, at the time the bid proposal is submitted, shall submit a listing of *DBE* participation, including the names and addresses on *Listing of DBE Subcontractors* contained elsewhere in the contract documents in order for the bid to be considered responsive. Bidders shall indicate the total dollar value of the DBE participation for the contract.
 - (b) If bidders have no DBE participation, they shall indicate this on the *Listing of DBE Subcontractors* by entering the word "None" or the number "0." This form shall be completed in its entirety. **Blank forms will not be deemed to represent zero participation.** Bids submitted that do not have DBE participation indicated on the appropriate form will not be read publicly during the opening of bids. The Department will not consider these bids for award and the proposal will be rejected.

- (c) The bidder shall be responsible for ensuring that the DBE is certified at the time of bid by checking the Directory of Transportation Firms. If the firm is not certified at the time of the bid-letting, that DBE's participation will not count towards achieving the corresponding goal.
- (2) *If the DBE goal is zero, entries on the Listing of DBE Subcontractors are not required for the zero goal, however any DBE participation that is achieved during the project shall be reported in accordance with requirements contained elsewhere in the special provision.*

DBE Prime Contractor

When a certified DBE firm bids on a contract that contains a DBE goal, the DBE firm is responsible for meeting the goal or making good faith efforts to meet the goal, just like any other bidder. In most cases, a DBE bidder on a contract will meet the DBE goal by virtue of the work it performs on the contract with its own forces. However, all the work that is performed by the DBE bidder and any other DBE subcontractors will count toward the DBE goal. The DBE bidder shall list itself along with any DBE subcontractors, if any, in order to receive credit toward the DBE goal.

For example, if the DBE goal is 45% and the DBE bidder will only perform 40% of the contract work, the prime will list itself at 40%, and the additional 5% shall be obtained through additional DBE participation with DBE subcontractors or documented through a good faith effort.

DBE prime contractors shall also follow Sections A and B listed under *Listing of DBE Subcontractor* just as a non-DBE bidder would.

Written Documentation – Letter of Intent

The bidder shall submit written documentation for each DBE that will be used to meet the DBE goal of the contract, indicating the bidder's commitment to use the DBE in the contract. This documentation shall be submitted on the Department's form titled *Letter of Intent*.

The documentation shall be received in the office of the State Contractor Utilization Engineer or at DBE@ncdot.gov no later than 10:00 a.m. of the sixth calendar day following opening of bids, unless the sixth day falls on an official state holiday. In that situation, it is due in the office of the State Contractor Utilization Engineer no later than 10:00 a.m. on the next official state business day.

If the bidder fails to submit the Letter of Intent from each committed DBE to be used toward the DBE goal, or if the form is incomplete (i.e. both signatures are not present), the DBE participation will not count toward meeting the DBE goal. If the lack of this participation drops the commitment below the DBE goal, the Contractor shall submit evidence of good faith efforts, completed in its entirety, to the State Contractor Utilization Engineer or DBE@ncdot.gov no later than 10:00 a.m. on the eighth calendar day following opening of bids, unless the eighth day falls on an official state holiday. In that situation, it is due in the office of the State Contractor Utilization Engineer no later than 10:00 a.m. on the next official state business day.

Submission of Good Faith Effort

If the bidder fails to meet or exceed the DBE goal, the apparent lowest responsive bidder shall submit to the Department documentation of adequate good faith efforts made to reach the DBE goal.

A hard copy and an electronic copy of this information shall be received in the office of the State Contractor Utilization Engineer or at DBE@ncdot.gov no later than 10:00 a.m. on the sixth calendar day following opening of bids unless the sixth day falls on an official state holiday. In that situation, it is due in the office of the State Contractor Utilization Engineer no later than 10:00 a.m. on the next official state business day. If the contractor cannot send the information electronically, then one complete set and 5 copies of this information shall be received under the same time constraints above.

Note: Where the information submitted includes repetitious solicitation letters, it will be acceptable to submit a representative letter along with a distribution list of the firms that were solicited. Documentation of DBE quotations shall be a part of the good faith effort submittal. This documentation may include written subcontractor quotations, telephone log notations of verbal quotations, or other types of quotation documentation.

Consideration of Good Faith Effort for Projects with DBE Goals More Than Zero

Adequate good faith efforts mean that the bidder took all necessary and reasonable steps to achieve the goal which, by their scope, intensity, and appropriateness, could reasonably be expected to obtain sufficient DBE participation. Adequate good faith efforts also mean that the bidder actively and aggressively sought DBE participation. Mere *pro forma* efforts are not considered good faith efforts.

The Department will consider the quality, quantity, and intensity of the different kinds of efforts a bidder has made. Listed below are examples of the types of actions a bidder will take in making a good faith effort to meet the goal and are not intended to be exclusive or exhaustive, nor is it intended to be a mandatory checklist.

- (A) Soliciting through all reasonable and available means (e.g. attendance at pre-bid meetings, advertising, written notices, use of verifiable electronic means through the use of the NCDOT Directory of Transportation Firms) the interest of all certified DBEs who have the capability to perform the work of the contract. The bidder must solicit this interest within at least 10 days prior to bid opening to allow the DBEs to respond to the solicitation. Solicitation shall provide the opportunity to DBEs within the Division and surrounding Divisions where the project is located. The bidder must determine with certainty if the DBEs are interested by taking appropriate steps to follow up initial solicitations.

- (B) Selecting portions of the work to be performed by DBEs in order to increase the likelihood that the DBE goals will be achieved.
 - (1) Where appropriate, break out contract work items into economically feasible units to facilitate DBE participation, even when the prime contractor might otherwise prefer to perform these work items with its own forces.
 - (2) Negotiate with subcontractors to assume part of the responsibility to meet the contract DBE goal when the work to be sublet includes potential for DBE participation (2nd and 3rd tier subcontractors).
- (C) Providing interested DBEs with adequate information about the plans, specifications, and requirements of the contract in a timely manner to assist them in responding to a solicitation.
- (D)
 - (1) Negotiating in good faith with interested DBEs. It is the bidder's responsibility to make a portion of the work available to DBE subcontractors and suppliers and to select those portions of the work or material needs consistent with the available DBE subcontractors and suppliers, to facilitate DBE participation. Evidence of such negotiation includes the names, addresses, and telephone numbers of DBEs that were considered; a description of the information provided regarding the plans and specifications for the work selected for subcontracting; and evidence as to why additional agreements could not be reached for DBEs to perform the work.
 - (2) A bidder using good business judgment would consider a number of factors in negotiating with subcontractors, including DBE subcontractors, and would take a firm's price and capabilities as well as contract goals into consideration. However, the fact that there may be some additional costs involved in finding and using DBEs is not in itself sufficient reason for a bidder's failure to meet the contract DBE goal, as long as such costs are reasonable. Also, the ability or desire of a prime contractor to perform the work of a contract with its own organization does not relieve the bidder of the responsibility to make good faith efforts. Bidding contractors are not, however, required to accept higher quotes from DBEs if the price difference is excessive or unreasonable.
- (E) Not rejecting DBEs as being unqualified without sound reasons based on a thorough investigation of their capabilities. The bidder's standing within its industry, membership in specific groups, organizations, or associates and political or social affiliations (for example, union vs. non-union employee status) are not legitimate causes for the rejection or non-solicitation of bids in the bidder's efforts to meet the project goal.
- (F) Making efforts to assist interested DBEs in obtaining bonding, lines of credit, or insurance as required by the recipient or bidder.
- (G) Making efforts to assist interested DBEs in obtaining necessary equipment, supplies, materials, or related assistance or services.

- (H) Effectively using the services of available minority/women community organizations; minority/women contractors' groups; Federal, State, and local minority/women business assistance offices; and other organizations as allowed on a case-by-case basis to provide assistance in the recruitment and placement of DBEs. Contact within 7 days from the bid opening the Business Opportunity and Work Force Development Unit at BOWD@ncdot.gov to give notification of the bidder's inability to get DBE quotes.
- (I) Any other evidence that the bidder submits which shows that the bidder has made reasonable good faith efforts to meet the DBE goal.

In addition, the Department may take into account the following:

- (1) Whether the bidder's documentation reflects a clear and realistic plan for achieving the DBE goal.
- (2) The bidders' past performance in meeting the DBE goals.
- (3) The performance of other bidders in meeting the DBE goal. For example, when the apparent successful bidder fails to meet the DBE goal, but others meet it, you may reasonably raise the question of whether, with additional reasonable efforts the apparent successful bidder could have met the goal. If the apparent successful bidder fails to meet the DBE goal, but meets or exceeds the average DBE participation obtained by other bidders, the Department may view this, in conjunction with other factors, as evidence of the apparent successful bidder having made a good faith effort.

If the Department does not award the contract to the apparent lowest responsive bidder, the Department reserves the right to award the contract to the next lowest responsive bidder that can satisfy to the Department that the DBE goal can be met or that an adequate good faith effort has been made to meet the DBE goal.

Non-Good Faith Appeal

The State Prequalification Engineer will notify the contractor verbally and in writing of non-good faith. A contractor may appeal a determination of non-good faith made by the Goal Compliance Committee. If a contractor wishes to appeal the determination made by the Committee, they shall provide written notification to the State Prequalification Engineer or at DBE@ncdot.gov. The appeal shall be made within 2 business days of notification of the determination of non-good faith.

Counting DBE Participation Toward Meeting DBE Goal**(A) Participation**

The total dollar value of the participation by a committed DBE will be counted toward the contract goal requirement. The total dollar value of participation by a committed DBE will be based upon the value of work actually performed by the DBE and the actual payments to DBE firms by the Contractor.

(B) Joint Checks

Prior notification of joint check use shall be required when counting DBE participation for services or purchases that involves the use of a joint check. Notification shall be through submission of Form JC-1 (*Joint Check Notification Form*) and the use of joint checks shall be in accordance with the Department's Joint Check Procedures.

(C) Subcontracts (Non-Trucking)

A DBE may enter into subcontracts. Work that a DBE subcontracts to another DBE firm may be counted toward the contract goal requirement. Work that a DBE subcontracts to a non-DBE firm does not count toward the contract goal requirement. If a DBE contractor or subcontractor subcontracts a significantly greater portion of the work of the contract than would be expected on the basis of standard industry practices, it shall be presumed that the DBE is not performing a commercially useful function. The DBE may present evidence to rebut this presumption to the Department. The Department's decision on the rebuttal of this presumption is subject to review by the Federal Highway Administration but is not administratively appealable to USDOT.

(D) Joint Venture

When a DBE performs as a participant in a joint venture, the Contractor may count toward its contract goal requirement a portion of the total value of participation with the DBE in the joint venture, that portion of the total dollar value being a distinct clearly defined portion of work that the DBE performs with its forces.

(E) Suppliers

A contractor may count toward its DBE requirement 60 percent of its expenditures for materials and supplies required to complete the contract and obtained from a DBE regular dealer and 100 percent of such expenditures from a DBE manufacturer.

(F) Manufacturers and Regular Dealers

A contractor may count toward its DBE requirement the following expenditures to DBE firms that are not manufacturers or regular dealers:

- (1) The fees or commissions charged by a DBE firm for providing a *bona fide* service, such as professional, technical, consultant, or managerial services, or for

providing bonds or insurance specifically required for the performance of a DOT-assisted contract, provided the fees or commissions are determined to be reasonable and not excessive as compared with fees and commissions customarily allowed for similar services.

- (2) With respect to materials or supplies purchased from a DBE, which is neither a manufacturer nor a regular dealer, count the entire amount of fees or commissions charged for assistance in the procurement of the materials and supplies, or fees or transportation charges for the delivery of materials or supplies required on a job site (but not the cost of the materials and supplies themselves), provided the fees are determined to be reasonable and not excessive as compared with fees customarily allowed for similar services.

Commercially Useful Function

(A) DBE Utilization

The Contractor may count toward its contract goal requirement only expenditures to DBEs that perform a commercially useful function in the work of a contract. A DBE performs a commercially useful function when it is responsible for execution of the work of the contract and is carrying out its responsibilities by actually performing, managing, and supervising the work involved. To perform a commercially useful function, the DBE shall also be responsible with respect to materials and supplies used on the contract, for negotiating price, determining quality and quantity, ordering the material and installing (where applicable) and paying for the material itself. To determine whether a DBE is performing a commercially useful function, the Department will evaluate the amount of work subcontracted, industry practices, whether the amount the firm is to be paid under the contract is commensurate with the work it is actually performing and the DBE credit claimed for its performance of the work, and any other relevant factors.

(B) DBE Utilization in Trucking

The following factors will be used to determine if a DBE trucking firm is performing a commercially useful function:

- (1) The DBE shall be responsible for the management and supervision of the entire trucking operation for which it is responsible on a particular contract, and there shall not be a contrived arrangement for the purpose of meeting DBE goals.
- (2) The DBE shall itself own and operate at least one fully licensed, insured, and operational truck used on the contract.
- (3) The DBE receives credit for the total value of the transportation services it provides on the contract using trucks it owns, insures, and operates using drivers it employs.

- (4) The DBE may subcontract the work to another DBE firm, including an owner-operator who is certified as a DBE. The DBE who subcontracts work to another DBE receives credit for the total value of the transportation services the subcontracted DBE provides on the contract.
- (5) The DBE may also subcontract the work to a non-DBE firm, including from an owner-operator. The DBE who subcontracts the work to a non-DBE is entitled to credit for the total value of transportation services provided by the non-DBE subcontractor not to exceed the value of transportation services provided by DBE-owned trucks on the contract. Additional participation by non-DBE subcontractors receives credit only for the fee or commission it receives as a result of the subcontract arrangement. The value of services performed under subcontract agreements between the DBE and the Contractor will not count towards the DBE contract requirement.
- (6) A DBE may lease truck(s) from an established equipment leasing business open to the general public. The lease must indicate that the DBE has exclusive use of and control over the truck. This requirement does not preclude the leased truck from working for others during the term of the lease with the consent of the DBE, so long as the lease gives the DBE absolute priority for use of the leased truck. This type of lease may count toward the DBE's credit as long as the driver is under the DBE's payroll.
- (7) Subcontracted/leased trucks shall display clearly on the dashboard the name of the DBE that they are subcontracted/leased to and their own company name if it is not identified on the truck itself. Magnetic door signs are not permitted.

DBE Replacement

When a Contractor has relied on a commitment to a DBE subcontractor (or an approved substitute DBE subcontractor) to meet all or part of a contract goal requirement, the contractor shall not terminate the DBE subcontractor for convenience. This includes, but is not limited to, instances in which the Contractor seeks to perform the work of the terminated subcontractor with another DBE subcontractor, a non-DBE subcontractor, or with the Contractor's own forces or those of an affiliate.

The Contractor must give notice in writing both by certified mail and email to the DBE subcontractor, with a copy to the Engineer of its intent to request to terminate and/or substitute, and the reason for the request. The Contractor must give the DBE subcontractor five (5) business days to respond to the Contractor's Notice of Intent to Request Termination and/or Substitution. If the DBE subcontractor objects to the intended termination/substitution, the DBE, within five (5) business days must advise the Contractor and the Department of the reasons why the action should not be approved. The five-day notice period shall begin on the next business day after written notice is provided to the DBE subcontractor.

A committed DBE subcontractor may only be terminated after receiving the Department's written approval based upon a finding of good cause for the proposed termination and/or substitution. For purposes of this section, good cause shall include the following circumstances:

- (a) The listed DBE subcontractor fails or refuses to execute a written contract;
- (b) The listed DBE subcontractor fails or refuses to perform the work of its subcontract in a way consistent with normal industry standards. Provided, however, that good cause does not exist if the failure or refusal of the DBE subcontractor to perform its work on the subcontract results from the bad faith or discriminatory action of the prime contractor;
- (c) The listed DBE subcontractor fails or refuses to meet the prime contractor's reasonable, nondiscriminatory bond requirements;
- (d) The listed DBE subcontractor becomes bankrupt, insolvent, or exhibits credit unworthiness;
- (e) The listed DBE subcontractor is ineligible to work on public works projects because of suspension and debarment proceedings pursuant to 2 CFR Parts 180, 215 and 1,200 or applicable state law;
- (f) The listed DBE subcontractor is not a responsible contractor;
- (g) The listed DBE voluntarily withdraws from the project and provides written notice of withdrawal;
- (h) The listed DBE is ineligible to receive DBE credit for the type of work required;
- (i) A DBE owner dies or becomes disabled with the result that the listed DBE contractor is unable to complete its work on the contract;
- (j) Other documented good cause that compels the termination of the DBE subcontractor. Provided, that good cause does not exist if the prime contractor seeks to terminate a DBE it relied upon to obtain the contract so that the prime contractor can self-perform the work for which the DBE contractor was engaged or so that the prime contractor can substitute another DBE or non-DBE contractor after contract award.

The Contractor shall comply with the following for replacement of a committed DBE:

(A) Performance Related Replacement

When a committed DBE is terminated for good cause as stated above, an additional DBE that was submitted at the time of bid may be used to fulfill the DBE commitment. A good faith effort will only be required for removing a committed DBE if there were no additional DBEs submitted at the time of bid to cover the same amount of work as the DBE that was terminated.

If a replacement DBE is not found that can perform at least the same amount of work as the terminated DBE, the Contractor shall submit a good faith effort documenting the steps taken. Such documentation shall include, but not be limited to, the following:

- (1) Copies of written notification to DBEs that their interest is solicited in contracting the work defaulted by the previous DBE or in subcontracting other items of work in the contract.
- (2) Efforts to negotiate with DBEs for specific subbids including, at a minimum:
 - (a) The names, addresses, and telephone numbers of DBEs who were contacted.

- (b) A description of the information provided to DBEs regarding the plans and specifications for portions of the work to be performed.
 - (3) A list of reasons why DBE quotes were not accepted.
 - (4) Efforts made to assist the DBEs contacted, if needed, in obtaining bonding or insurance required by the Contractor.
- (B) Decertification Replacement
- (1) When a committed DBE is decertified by the Department after the SAF (*Subcontract Approval Form*) has been received by the Department, the Department will not require the Contractor to solicit replacement DBE participation equal to the remaining work to be performed by the decertified firm. The participation equal to the remaining work performed by the decertified firm will count toward the contract goal requirement.
 - (2) When a committed DBE is decertified prior to the Department receiving the SAF (*Subcontract Approval Form*) for the named DBE firm, the Contractor shall take all necessary and reasonable steps to replace the DBE subcontractor with another DBE subcontractor to perform at least the same amount of work to meet the DBE goal requirement. If a DBE firm is not found to do the same amount of work, a good faith effort must be submitted to NCDOT (see A herein for required documentation).
 - (3) Exception: If the DBE's ineligibility is caused solely by its having exceeded the size standard during the performance of the contract, the Department will not require the Contractor to solicit replacement DBE participation equal to the remaining work to be performed by the decertified firm. The participation equal to the remaining work performed by the decertified firm will count toward the contract goal requirement and overall goal.

All requests for replacement of a committed DBE firm shall be submitted to the Engineer for approval on Form RF-1 (*DBE Replacement Request*). If the Contractor fails to follow this procedure, the Contractor may be disqualified from further bidding for a period of up to 6 months.

Changes in the Work

When the Engineer makes changes that result in the reduction or elimination of work to be performed by a committed DBE, the Contractor will not be required to seek additional participation. When the Engineer makes changes that result in additional work to be performed by a DBE based upon the Contractor's commitment, the DBE shall participate in additional work to the same extent as the DBE participated in the original contract work.

When the Engineer makes changes that result in extra work, which has more than a minimal impact on the contract amount, the Contractor shall seek additional participation by DBEs unless otherwise approved by the Engineer.

When the Engineer makes changes that result in an alteration of plans or details of construction, and a portion or all of the work had been expected to be performed by a committed DBE, the Contractor shall seek participation by DBEs unless otherwise approved by the Engineer.

When the Contractor requests changes in the work that result in the reduction or elimination of work that the Contractor committed to be performed by a DBE, the Contractor shall seek additional participation by DBEs equal to the reduced DBE participation caused by the changes.

Reports and Documentation

A SAF (*Subcontract Approval Form*) shall be submitted for all work which is to be performed by a DBE subcontractor. The Department reserves the right to require copies of actual subcontract agreements involving DBE subcontractors.

When using transportation services to meet the contract commitment, the Contractor shall submit a proposed trucking plan in addition to the SAF. The plan shall be submitted prior to beginning construction on the project. The plan shall include the names of all trucking firms proposed for use, their certification type(s), the number of trucks owned by the firm, as well as the individual truck identification numbers, and the line item(s) being performed.

Within 30 calendar days of entering into an agreement with a DBE for materials, supplies or services, not otherwise documented by the SAF as specified above, the Contractor shall furnish the Engineer a copy of the agreement. The documentation shall also indicate the percentage (60% or 100%) of expenditures claimed for DBE credit.

Reporting Disadvantaged Business Enterprise Participation

The Contractor shall provide the Engineer with an accounting of payments made to all DBE firms, including material suppliers and contractors at all levels (prime, subcontractor, or second tier subcontractor). This accounting shall be furnished to the Engineer for any given month by the end of the following month. Failure to submit this information accordingly may result in the following action:

- (A) Withholding of money due in the next partial pay estimate; or
- (B) Removal of an approved contractor from the prequalified bidders' list or the removal of other entities from the approved subcontractors list.

While each contractor (prime, subcontractor, 2nd tier subcontractor) is responsible for accurate accounting of payments to DBEs, it shall be the prime contractor's responsibility to report all monthly and final payment information in the correct reporting manner.

Failure on the part of the Contractor to submit the required information in the time frame specified may result in the disqualification of that contractor and any affiliate companies from further bidding until the required information is submitted.

Failure on the part of any subcontractor to submit the required information in the time frame specified may result in the disqualification of that contractor and any affiliate companies from being approved for work on future DOT projects until the required information is submitted.

Contractors reporting transportation services provided by non-DBE lessees shall evaluate the value of services provided during the month of the reporting period only.

At any time, the Engineer can request written verification of subcontractor payments.

The Contractor shall report the accounting of payments through the Department's DBE Payment Tracking System.

Failure to Meet Contract Requirements

Failure to meet contract requirements in accordance with Subarticle 102-15(J) of the *Standard Specifications* may be cause to disqualify the Contractor.

CERTIFICATION FOR FEDERAL-AID CONTRACTS:

(3-21-90)

SP1 G85

The prospective participant certifies, by signing and submitting this bid or proposal, to the best of his or her knowledge and belief, that:

- (A) No Federal appropriated funds have been paid or will be paid, by or on behalf of the undersigned, to any person for influencing or attempting to influence an officer or employee of any Federal agency, a Member of Congress, an officer or employee of Congress, or an employee of a Member of Congress in connection with the awarding of any Federal contract, the making of any Federal grant, the making of any Federal loan, the entering into of any cooperative agreement, and the extension, continuation, renewal, amendment, or modification of any Federal contract, grant, loan, or cooperative agreement.
- (B) If any funds other than Federal appropriated funds have been paid or will be paid to any person for influencing or attempting to influence an officer or employee of any Federal agency, a Member of Congress, an officer or employee of Congress, or an employee of a Member of Congress in connection with this Federal contract, grant, loan, or cooperative agreement, the undersigned shall complete and submit Standard Form-LLL, *Disclosure Form to Report Lobbying*, in accordance with its instructions.

This certification is a material representation of fact upon which reliance was placed when this transaction was made or entered into. Submission of this certification is a prerequisite for making or entering into this transaction imposed by *Section 1352, Title 31, U.S. Code*. Any person who fails to file the required certification shall be subject to a civil penalty of not less than \$10,000 and not more than \$100,000 for each such failure.

The prospective participant also agrees by submitting his or her bid or proposal that he or she shall require that the language of this certification be included in all lower tier subcontracts, which exceed \$100,000 and that all such subrecipients shall certify and disclose accordingly.

RESTRICTIONS ON ITS EQUIPMENT AND SERVICES:

(11-17-20)

SP1 G090

All telecommunications, video or other ITS equipment or services installed or utilized on this project must be in conformance with UNIFORM ADMINISTRATIVE REQUIREMENTS, COST PRINCIPLES, AND AUDIT REQUIREMENTS FOR FEDERAL AWARDS **2 CFR, § 200.216 Prohibition on certain telecommunications and video surveillance services or equipment.**

USE OF UNMANNED AIRCRAFT SYSTEM (UAS):

(8-20-19)

SP1 G092

The Contractor shall adhere to all Federal, State and Local regulations and guidelines for the use of Unmanned Aircraft Systems (UAS). This includes but is not limited to US 14 CFR Part 107 *Small UAS Rule*, NC GS 15A-300.2 *Regulation of launch and recovery sites*, NC GS 63-95 *Training required for the operation of unmanned aircraft systems*, NC GS 63-96 *Permit required for commercial operation of unmanned aircraft system*, and NCDOT UAS Policy. The required operator certifications include possessing a current Federal Aviation Administration (FAA) Remote Pilot Certificate, a NC UAS Operator Permit as well as operating a UAS registered with the FAA.

Prior to beginning operations, the Contractor shall complete the NCDOT UAS – Flight Operation Approval Form and submit it to the Engineer for approval. All UAS operations shall be approved by the Engineer prior to beginning the operations.

All contractors or subcontractors operating UAS shall have UAS specific general liability insurance to cover all operations under this contract.

The use of UAS is at the Contractor's discretion. No measurement or payment will be made for the use of UAS. In the event that the Department directs the Contractor to utilize UAS, payment will be in accordance with Article 104-7 Extra Work.

EQUIPMENT IDLING GUIDELINES:

(1-19-21)

107

SP1 G096

Exercise reduced fuel consumption and reduced equipment emissions during the construction of all work associated with this contract. Employees engaged in the construction of this project should turn off vehicles when stopped for more than thirty (30) minutes and off-highway equipment should idle no longer than fifteen (15) consecutive minutes.

These guidelines for turning off vehicles and equipment when idling do not apply to:

1. Idling when queuing.
2. Idling to verify the vehicle is in safe operating condition.
3. Idling for testing, servicing, repairing or diagnostic purposes.
4. Idling necessary to accomplish work for which the vehicle was designed (such as operating a crane, mixing concrete, etc.).
5. Idling required to bring the machine system to operating temperature.

6. Emergency vehicles, utility company, construction, and maintenance vehicles where the engines must run to perform needed work.
7. Idling to ensure safe operation of the vehicle.
8. Idling when the propulsion engine is providing auxiliary power for other than heating or air conditioning. (such as hydraulic systems for pavers)
9. When specific traffic, safety, or emergency situations arise.
10. If the ambient temperature is less than 32 degrees Fahrenheit. Limited idling to provide for the safety of vehicle occupants (e.g. to run the heater).
11. If the ambient temperature is greater than 90 degrees Fahrenheit. Limited idling to provide for the safety of vehicle occupants of off-highway equipment (e.g. to run the air conditioning) no more than 30 minutes.
12. Diesel powered vehicles may idle for up to 30 minutes to minimize restart problems.

Any vehicle, truck, or equipment in which the primary source of fuel is natural gas or electricity is exempt from the idling limitations set forth in this special provision.

U.S. DEPARTMENT OF TRANSPORTATION HOTLINE:

(11-22-94)

108-5

SP1 G100

To report bid rigging activities call: **1-800-424-9071**

The U.S. Department of Transportation (DOT) operates the above toll-free hotline Monday through Friday, 8:00 a.m. to 5:00 p.m. eastern time. Anyone with knowledge of possible bid rigging, bidder collusion, or other fraudulent activities should use the hotline to report such activities.

The hotline is part of the DOT's continuing effort to identify and investigate highway construction contract fraud and abuse is operated under the direction of the DOT Inspector General. All information will be treated confidentially and caller anonymity will be respected.

SUBSURFACE INFORMATION:

(7-1-95)

450

SP1 G112 C

Subsurface information is available on the roadway and structure portions of this project.

PORTABLE CONCRETE BARRIER - (Partial Payments for Materials):

(7-1-95)(Rev. 1-16-24)

1170-4

SP1 G121

When so authorized by the Engineer, partial materials payments will be made up to 95 percent of the delivered cost of portable concrete barrier, provided that these materials have been delivered on the project and stored in an acceptable manner, and further provided the documents listed in Subarticle 109-5(C) of the *Standard Specifications* have been furnished to the Engineer.

The provisions of Subarticle 109-5(B) of the *Standard Specifications* will apply to the portable concrete barrier.

TWELVE MONTH GUARANTEE:

(7-15-03)

108

SP1 G145

- (A) The Contractor shall guarantee materials and workmanship against latent and patent defects arising from faulty materials, faulty workmanship or negligence for a period of twelve months following the date of final acceptance of the work for maintenance and shall replace such defective materials and workmanship without cost to the Department. The Contractor will not be responsible for damage due to faulty design, normal wear and tear, for negligence on the part of the Department, and/or for use in excess of the design.
- (B) Where items of equipment or material carry a manufacturer's guarantee for any period in excess of twelve months, then the manufacturer's guarantee shall apply for that particular piece of equipment or material. The Department's first remedy shall be through the manufacturer although the Contractor is responsible for invoking the warranted repair work with the manufacturer. The Contractor's responsibility shall be limited to the term of the manufacturer's guarantee. NCDOT would be afforded the same warranty as provided by the Manufacturer.

This guarantee provision shall be invoked only for major components of work in which the Contractor would be wholly responsible for under the terms of the contract. Examples would include pavement structures, bridge components, and sign structures. This provision will not be used as a mechanism to force the Contractor to return to the project to make repairs or perform additional work that the Department would normally compensate the Contractor for. In addition, routine maintenance activities (i.e. mowing grass, debris removal, ruts in earth shoulders,) are not parts of this guarantee.

Appropriate provisions of the payment and/or performance bonds shall cover this guarantee for the project.

To ensure uniform application statewide the Division Engineer will forward details regarding the circumstances surrounding any proposed guarantee repairs to the Chief Engineer for review and approval prior to the work being performed.

EROSION AND SEDIMENT CONTROL/STORMWATER CERTIFICATION:

(1-16-07) (Rev 12-15-20)

105-16, 225-2, 16

SP1 G180

General

Schedule and conduct construction activities in a manner that will minimize soil erosion and the resulting sedimentation and turbidity of surface waters. Comply with the requirements herein regardless of whether or not a National Pollution discharge Elimination System (NPDES) permit for the work is required.

Establish a chain of responsibility for operations and subcontractors' operations to ensure that the *Erosion and Sediment Control/Stormwater Pollution Prevention Plan* is implemented and maintained over the life of the contract.

- (A) *Certified Supervisor* - Provide a certified Erosion and Sediment Control/Stormwater Supervisor to manage the Contractor and subcontractor operations, insure compliance

with Federal, State and Local ordinances and regulations, and manage the Quality Control Program.

- (B) *Certified Foreman* - Provide a certified, trained foreman for each construction operation that increases the potential for soil erosion or the possible sedimentation and turbidity of surface waters.
- (C) *Certified Installer* - Provide a certified installer to install or direct the installation for erosion or sediment/stormwater control practices.
- (D) *Certified Designer* - Provide a certified designer for the design of the erosion and sediment control/stormwater component of reclamation plans and, if applicable, for the design of the project erosion and sediment control/stormwater plan.

Roles and Responsibilities

- (A) *Certified Erosion and Sediment Control/Stormwater Supervisor* - The Certified Supervisor shall be Level II and responsible for ensuring the erosion and sediment control/stormwater plan is adequately implemented and maintained on the project and for conducting the quality control program. The Certified Supervisor shall be on the project within 24 hours notice from initial exposure of an erodible surface to the project's final acceptance. Perform the following duties:
 - (1) **Manage Operations** - Coordinate and schedule the work of subcontractors so that erosion and sediment control/stormwater measures are fully executed for each operation and in a timely manner over the duration of the contract.
 - (a) Oversee the work of subcontractors so that appropriate erosion and sediment control/stormwater preventive measures are conformed to at each stage of the work.
 - (b) Prepare the required National Pollutant Discharge Elimination System (NPDES) Inspection Record and submit to the Engineer.
 - (c) Attend all weekly or monthly construction meetings to discuss the findings of the NPDES inspection and other related issues.
 - (d) Implement the erosion and sediment control/stormwater site plans requested.
 - (e) Provide any needed erosion and sediment control/stormwater practices for the Contractor's temporary work not shown on the plans, such as, but not limited to work platforms, temporary construction, pumping operations, plant and storage yards, and cofferdams.
 - (f) Acquire applicable permits and comply with requirements for borrow pits, dewatering, and any temporary work conducted by the Contractor in jurisdictional areas.
 - (g) Conduct all erosion and sediment control/stormwater work in a timely and workmanlike manner.
 - (h) Fully perform and install erosion and sediment control/stormwater work prior to any suspension of the work.

- (i) Coordinate with Department, Federal, State and Local Regulatory agencies on resolution of erosion and sediment control/stormwater issues due to the Contractor's operations.
 - (j) Ensure that proper cleanup occurs from vehicle tracking on paved surfaces or any location where sediment leaves the Right-of-Way.
 - (k) Have available a set of erosion and sediment control/stormwater plans that are initialed and include the installation date of Best Management Practices. These practices shall include temporary and permanent groundcover and be properly updated to reflect necessary plan and field changes for use and review by Department personnel as well as regulatory agencies.
- (2) Requirements set forth under the NPDES Permit - The Department's NPDES Stormwater permit (NCS000250) outlines certain objectives and management measures pertaining to construction activities. The permit references *NCG010000, General Permit to Discharge Stormwater* under the NPDES, and states that the Department shall incorporate the applicable requirements into its delegated Erosion and Sediment Control Program for construction activities disturbing one or more acres of land. The Department further incorporates these requirements on all contracted bridge and culvert work at jurisdictional waters, regardless of size. Some of the requirements are, but are not limited to:
- (a) Control project site waste to prevent contamination of surface or ground waters of the state, i.e. from equipment operation/maintenance, construction materials, concrete washout, chemicals, litter, fuels, lubricants, coolants, hydraulic fluids, any other petroleum products, and sanitary waste.
 - (b) Inspect erosion and sediment control/stormwater devices and stormwater discharge outfalls at least once every 7 calendar days and within 24 hours after a rainfall event equal to or greater than 1.0 inch that occurs within a 24 hour period. Additional monitoring may be required at the discretion of Division of Water Resources personnel if the receiving stream is 303(d) listed for turbidity and the project has had documented problems managing turbidity.
 - (c) Maintain an onsite rain gauge or use the Department's Multi-Sensor Precipitation Estimate website to maintain a daily record of rainfall amounts and dates.
 - (d) Maintain erosion and sediment control/stormwater inspection records for review by Department and Regulatory personnel upon request.
 - (e) Implement approved reclamation plans on all borrow pits, waste sites and staging areas.
 - (f) Maintain a log of turbidity test results as outlined in the Department's Procedure for Monitoring Borrow Pit Discharge.
 - (g) Provide secondary containment for bulk storage of liquid materials.
 - (h) Provide training for employees concerning general erosion and sediment control/stormwater awareness, the Department's NPDES Stormwater Permit NCS000250 requirements, and the applicable requirements of the *General Permit, NCG010000*.

- (i) Report violations of the NPDES permit to the Engineer immediately who will notify the Division of Water Quality Regional Office within 24 hours of becoming aware of the violation.
- (3) Quality Control Program - Maintain a quality control program to control erosion, prevent sedimentation and follow provisions/conditions of permits. The quality control program shall:
- (a) Follow permit requirements related to the Contractor and subcontractors' construction activities.
 - (b) Ensure that all operators and subcontractors on site have the proper erosion and sediment control/stormwater certification.
 - (c) Notify the Engineer when the required certified erosion and sediment control/stormwater personnel are not available on the job site when needed.
 - (d) Conduct the inspections required by the NPDES permit.
 - (e) Take corrective actions in the proper timeframe as required by the NPDES permit for problem areas identified during the NPDES inspections.
 - (f) Incorporate erosion control into the work in a timely manner and stabilize disturbed areas with mulch/seed or vegetative cover on a section-by-section basis.
 - (g) Use flocculants approved by state regulatory authorities where appropriate and where required for turbidity and sedimentation reduction.
 - (h) Ensure proper installation and maintenance of temporary erosion and sediment control devices.
 - (i) Remove temporary erosion or sediment control devices when they are no longer necessary as agreed upon by the Engineer.
 - (j) The Contractor's quality control and inspection procedures shall be subject to review by the Engineer. Maintain NPDES inspection records and make records available at all times for verification by the Engineer.
- (B) *Certified Foreman* - At least one Certified Foreman shall be onsite for each type of work listed herein during the respective construction activities to control erosion, prevent sedimentation and follow permit provisions:
- (1) Foreman in charge of grading activities
 - (2) Foreman in charge of bridge or culvert construction over jurisdictional areas
 - (3) Foreman in charge of utility activities

The Contractor may request to use the same person as the Level II Supervisor and Level II Foreman. This person shall be onsite whenever construction activities as described above are taking place. This request shall be approved by the Engineer prior to work beginning.

The Contractor may request to name a single Level II Foreman to oversee multiple construction activities on small bridge or culvert replacement projects. This request shall be approved by the Engineer prior to work beginning.

(C) *Certified Installers* - Provide at least one onsite, Level I Certified Installer for each of the following erosion and sediment control/stormwater crew:

- (1) Seeding and Mulching
- (2) Temporary Seeding
- (3) Temporary Mulching
- (4) Sodding
- (5) Silt fence or other perimeter erosion/sediment control device installations
- (6) Erosion control blanket installation
- (7) Hydraulic tackifier installation
- (8) Turbidity curtain installation
- (9) Rock ditch check/sediment dam installation
- (10) Ditch liner/matting installation
- (11) Inlet protection
- (12) Riprap placement
- (13) Stormwater BMP installations (such as but not limited to level spreaders, retention/detention devices)
- (14) Pipe installations within jurisdictional areas

If a Level I *Certified Installer* is not onsite, the Contractor may substitute a Level II Foreman for a Level I Installer, provided the Level II Foreman is not tasked to another crew requiring Level II Foreman oversight.

(D) *Certified Designer* - Include the certification number of the Level III Certified Designer on the erosion and sediment control/stormwater component of all reclamation plans and if applicable, the certification number of the Level III Certified Designer on the design of the project erosion and sediment control/stormwater plan.

Preconstruction Meeting

Furnish the names of the *Certified Erosion and Sediment Control/Stormwater Supervisor*, *Certified Foremen*, *Certified Installers* and *Certified Designer* and notify the Engineer of changes in certified personnel over the life of the contract within 2 days of change.

Ethical Responsibility

Any company performing work for the North Carolina Department of Transportation has the ethical responsibility to fully disclose any reprimand or dismissal of an employee resulting from improper testing or falsification of records.

Revocation or Suspension of Certification

Upon recommendation of the Chief Engineer to the certification entity, certification for *Supervisor*, *Certified Foremen*, *Certified Installers* and *Certified Designer* may be revoked or suspended with the issuance of an *Immediate Corrective Action (ICA)*, *Notice of Violation (NOV)*, or *Cease and Desist Order* for erosion and sediment control/stormwater related issues.

The Chief Engineer may recommend suspension or permanent revocation of certification due to the following:

- (A) Failure to adequately perform the duties as defined within this certification provision.
- (B) Issuance of an ICA, NOV, or Cease and Desist Order.
- (C) Failure to fully perform environmental commitments as detailed within the permit conditions and specifications.
- (D) Demonstration of erroneous documentation or reporting techniques.
- (E) Cheating or copying another candidate's work on an examination.
- (F) Intentional falsification of records.
- (G) Directing a subordinate under direct or indirect supervision to perform any of the above actions.
- (H) Dismissal from a company for any of the above reasons.
- (I) Suspension or revocation of one's certification by another entity.

Suspension or revocation of a certification will be sent by certified mail to the certificant and the Corporate Head of the company that employs the certificant.

A certificant has the right to appeal any adverse action which results in suspension or permanent revocation of certification by responding, in writing, to the Chief Engineer within 10 calendar days after receiving notice of the proposed adverse action.

Chief Engineer
1536 Mail Service Center
Raleigh, NC 27699-1536

Failure to appeal within 10 calendar days will result in the proposed adverse action becoming effective on the date specified on the certified notice. Failure to appeal within the time specified will result in a waiver of all future appeal rights regarding the adverse action taken. The certificant will not be allowed to perform duties associated with the certification during the appeal process.

The Chief Engineer will hear the appeal and make a decision within 7 days of hearing the appeal. Decision of the Chief Engineer will be final and will be made in writing to the certificant.

If a certification is temporarily suspended, the certificant shall pass any applicable written examination and any proficiency examination, at the conclusion of the specified suspension period, prior to having the certification reinstated.

Measurement and Payment

Certified Erosion and Sediment Control/Stormwater Supervisor, Certified Foremen, Certified Installers and Certified Designer will be incidental to the project for which no direct compensation will be made.

PROCEDURE FOR MONITORING BORROW PIT DISCHARGE:

(2-20-07) (Rev. 1-16-24)

105-16, 230, 801

SP1 G181

Water discharge from borrow pit sites shall not cause surface waters to exceed 50 NTUs (nephelometric turbidity unit) in streams not designated as trout waters and 10 NTUs in streams, lakes or reservoirs designated as trout waters. For lakes and reservoirs not designated as trout waters, the turbidity shall not exceed 25 NTUs. If the turbidity exceeds these levels due to natural background conditions, the existing turbidity level shall not be increased.

If during any operating day, the downstream water quality exceeds the standard, the Contractor shall do all of the following:

- (A) Either cease discharge or modify the discharge volume or turbidity levels to bring the downstream turbidity levels into compliance, or
- (B) Evaluate the upstream conditions to determine if the exceedance of the standard is due to natural background conditions. If the background turbidity measurements exceed the standard, operation of the pit and discharge can continue as long as the stream turbidity levels are not increased due to the discharge.
- (C) Measure and record the turbidity test results (time, date and sampler) at all defined sampling locations 30 minutes after startup and at a minimum, one additional sampling of all sampling locations during that 24-hour period in which the borrow pit is discharging.
- (D) Notify DWQ within 24 hours of any stream turbidity standard exceedances that are not brought into compliance.

During the Environmental Assessment required by Article 230-4 of the *Standard Specifications*, the Contractor shall define the point at which the discharge enters into the State's surface waters and the appropriate sampling locations. Sampling locations shall include points upstream and downstream from the point at which the discharge enters these waters. Upstream sampling location shall be located so that it is not influenced by backwater conditions and represents natural background conditions. Downstream sampling location shall be located at the point where complete mixing of the discharge and receiving water has occurred.

The discharge shall be closely monitored when water from the dewatering activities is introduced into jurisdictional wetlands. Any time visible sedimentation (deposition of sediment) on the wetland surface is observed, the dewatering activity will be suspended until turbidity levels in the stilling basin can be reduced to a level where sediment deposition does not occur. Staining of wetland surfaces from suspended clay particles, occurring after evaporation or infiltration, does not constitute sedimentation. No activities shall occur in wetlands that adversely affect the functioning of a wetland. Visible sedimentation will be considered an indication of possible adverse impacts on wetland use.

The Engineer will perform independent turbidity tests on a random basis. These results will be maintained in a log within the project records. Records will include, at a minimum, turbidity test results, time, date and name of sampler. Should the Department's test results exceed those of the Contractor's test results, an immediate test shall be performed jointly with the results superseding the previous test results of both the Department and the Contractor.

The Contractor shall use the *NCDOT Turbidity Reduction Options for Borrow Pits Matrix*, available at <https://connect.ncdot.gov/resources/roadside/FieldOperationsDocuments/TurbidityReductionOptionSheet.pdf> to plan, design, construct, and maintain BMPs to address water quality standards. Tier I Methods include stilling basins which are standard compensatory BMPs. Other Tier I methods are noncompensatory and shall be used when needed to meet the stream turbidity standards. Tier II Methods are also noncompensatory and are options that may be needed for protection of rare or unique resources or where special environmental conditions exist at the site which have led to additional requirements being placed in the DWQ's 401 Certifications and approval letters, Isolated Wetland Permits, Riparian Buffer Authorization or a DOT Reclamation Plan's Environmental Assessment for the specific site. Should the Contractor exhaust all Tier I Methods on a site exclusive of rare or unique resources or special environmental conditions, Tier II Methods may be required by regulators on a case by case basis per supplemental agreement.

The Contractor may use cation exchange capacity (CEC) values from proposed site borings to plan and develop the bid for the project. CEC values exceeding 15 milliequivalents per 100 grams of soil may indicate a high potential for turbidity and should be avoided when dewatering into surface water is proposed.

No additional compensation for monitoring borrow pit discharge will be paid.

PROJECT SPECIAL PROVISIONS**ROADWAY****CLEARING AND GRUBBING - METHOD III:**

(4-6-06)(Rev. 3-19-24)

200

SP2 R02B

Perform clearing on this project to the limits established by Method - III shown on Standard Drawing No. 200.03 of the *Roadway Standard Drawings*. Conventional clearing methods may be used except where permit drawings or conditions have been included in the proposal which require certain areas to be cleared by hand methods.

BURNING RESTRICTIONS:

(7-1-95)

200, 210, 215

SP2 R05

Open burning is not permitted on any portion of the right-of-way limits established for this project. Do not burn the clearing, grubbing or demolition debris designated for disposal and generated from the project at locations within the project limits, off the project limits or at any waste or borrow sites in this county. Dispose of the clearing, grubbing and demolition debris by means other than burning, according to state or local rules and regulations.

SHOULDER AND FILL SLOPE MATERIAL:

(5-21-02)(Rev. 1-16-24)

235, 560

SP2 R45 A

Description

Perform the required shoulder and slope construction for this project in accordance with the applicable requirements of Section 560 and Section 235 of the *Standard Specifications*.

Measurement and Payment

Where the material has been obtained from an authorized stockpile or from a borrow source and *Borrow Excavation* is not included in the contract, no direct payment will be made for this work, as the cost of this work will be part of the work being paid at the contract lump sum price for *Grading*. If *Borrow Excavation* is included in this contract and the material has been obtained from an authorized stockpile or from a borrow source, measurement and payment will be as provided in Section 230 of the *Standard Specifications* for *Borrow Excavation*.

MANUFACTURED QUARRY FINES IN EMBANKMENTS:

(01-17-17)(Rev. 4-16-24)

235

SP02 R72

Description

This specification addresses the use of manufactured quarry fines that are not classified as select materials. The specification allows the Contractor an option, with the approval of the Engineer, to use manufactured quarry fines (MQFs) in embankments as a substitute for conventional borrow material. Furnish and place geotextile for subgrade stabilization in accordance with the contract. Geotextile for subgrade stabilization is required to prevent pavement cracking and provide separation between the subgrade and pavement section at embankment locations where manufactured quarry fines are utilized and as directed by the Engineer.

Materials

Manufactured Quarry Fines.

Site specific approval of MQFs material will be required prior to beginning construction as detailed in the preconstruction requirements of this provision.

The following MQFs are unacceptable:

- (A) Frozen material,
- (B) Material with a maximum dry unit weight of less than 90 pounds per cubic foot when tested in accordance with AASHTO T 99 Method A or C.
- (C) Material with greater than 80% by weight Passing the #200 sieve

Collect and transport MQFs in a manner that will prevent nuisances and hazards to public health and safety. Moisture condition the MQFs as needed and transport in covered trucks to prevent dusting. If MQFs are blended with natural earth material, follow Borrow Criteria in Section 1018 of the *Standard Specifications*.

Preconstruction Requirements

When MQFs are to be used as a substitute for earth borrow material, request written approval from the Engineer at least ninety (90) days in advance of the intent to use MQFs and include the following details:

- (A) Description, purpose and location of project.
- (B) Estimated start and completion dates of project.
- (C) Estimated volume of MQFs to be used on project with specific locations and construction details of the placement.
- (D) The names, address, and contact information for the generator of the MQFs.
- (E) Physical location of the site at which the MQFs were generated.

The Engineer will forward this information to the State Materials Engineer for review and material approval.

Construction Methods

Place MQFs in the core of the embankment section with at least 4 feet of earth cover to the outside limits of the embankments or subgrade.

Construct embankments by placing MQFs in level uniform lifts with no more than a lift of 10 inches and compacted to at least a density of 95 percent as determined by test methods in AASHTO T 99, Determination of Maximum Dry Density and Optimum Moisture Content, Method A or C depending upon particle size of the product. Provide a moisture content at the time of compaction of within 4 percent of optimum but not greater than one percent above optimum as determined by AASHTO T 99, Method A or C.

In embankments where MQFs are incorporated, geotextile for subgrade stabilization shall be used. Refer to Article 505-2 of the *Standard Specifications* for geotextile type and Article 505-3

of the *Standard Specifications* for the geotextile construction methods.

Measurement and Payment

Borrow Excavation will be measured by truck volume and paid in cubic yards in accordance with Article 230-5 of the *Standard Specifications*. As an alternate weigh tickets can be provided and payment made by converting weight to cubic yards based on the verifiable unit weight. Where the pay item for *Borrow Excavation* is not included in the original contract then no separate payment will be made for this item and payment will be included in the lump sum price bid for *Grading*.

Geotextile for Subgrade Stabilization will be measured and paid in accordance with Article 505-4 of the *Standard Specifications*. When the pay item for *Geotextile for Subgrade Stabilization* is not included in the original contract then no payment will be made for this item and will be considered incidental to the use of MQFs in embankment.

FLOWABLE FILL:

(9-17-02) (Rev. 1-16-24)

300, 340, 1000, 1530, 1540, 1550

SP3 R30

Description

This work consists of all work necessary to place flowable fill in accordance with these provisions, the plans, and as directed.

Materials

Refer to Division 10 of the *Standard Specifications*.

Item

Flowable Fill

Section

1000-7

Construction Methods

Discharge flowable fill material directly from the truck into the space to be filled, or by other approved methods. The mix may be placed full depth or in lifts as site conditions dictate. The Contractor shall provide a method to plug the ends of the existing pipe in order to contain the flowable fill.

Measurement and Payment

At locations where flowable fill is called for on the plans and a pay item for flowable fill is included in the contract, *Flowable Fill* will be measured in cubic yards and paid as the actual number of cubic yards that have been satisfactorily placed and accepted. Such price and payment will be full compensation for all work covered by this provision including, but not limited to, the mix design, furnishing, hauling, placing and containing the flowable fill.

Payment will be made under:

Pay Item

Flowable Fill

Pay Unit

Cubic Yard

CORRUGATED ALUMINUM ALLOY CULVERT PIPE:

(9-21-21)(Rev. 1-16-24)

305, 310

SP3 R34

Revise the *Standard Specifications* as follows:

Page 3-5, Article 305-2, MATERIALS, add the following after line 16:

Item

Waterborne Paint

Hot Bitumen

Section

1080-9

1081-3

Page 3-5, Article 305-3, CONSTRUCTION METHODS, add the following after line 26:

Coating must be applied to the aluminum when in contact with concrete. Immediately prior to coating, aluminum surfaces to be coated shall be cleaned by a method that will remove all dirt, oil, grease, chips, and other foreign substances. Aluminum to be coated shall be given one coat of suitable quality coating such as:

Approved waterborne paint (Section 1080-9)

Approved Hot Bitumen (Section 1081-3)

Other coating materials may be submitted to the Engineer for approval.

Page 3-7, Article 310-6, MEASUREMENT AND PAYMENT, lines 10-11, delete the fourth sentence and replace with the following:

Select bedding and backfill material and coating will be included in the cost of the installed pipe.

BRIDGE APPROACH FILLS:

(10-19-10)(Rev. 1-16-24)

422

SP4 R02

Description

Bridge approach fills consist of backfilling behind bridge end bents with select material or aggregate to support all or part of bridge approach slabs. Install outlets and grade bridge approach fills to drain water through and away from approach fills. Install geotextiles to allow for possible future slab jacking and separate approach fills from embankment fills, natural ground and pavement sections as required. For bridge approach fills behind end bents with mechanically stabilized earth (MSE) abutment walls, reinforce bridge approach fills with MSE wall reinforcement connected to end bent caps as required. Construct bridge approach fills in accordance with the contract, accepted submittals and bridge approach fill *Roadway Standard Drawings*.

Define bridge approach fill types as follows:

Type 1 Approach Fill – Approach fill for bridge abutment in accordance with *Roadway Standard Drawing No. 423.01*;

Type 1A Approach Fill – Alternate approach fill for integral bridge abutment in accordance with *Roadway Standard Drawing No. 423.02*;

Type 2 Approach Fill – Approach fill for bridge abutment with MSE wall in accordance with *Roadway Standard Drawing No. 423.03* and

Type 2A Approach Fill – Alternate approach fill for integral bridge abutment with MSE wall in accordance with *Roadway Standard Drawing No. 423.04*.

At the Contractors option, use Type 1A or 2A approach fills instead of Type 1 or 2 approach fills, respectively, for integral bridge abutments. Type 1A and 2A approach fills consists of constructing an approach fill with a temporary geotextile wall before placing all or a portion of the concrete for the backwall and wing walls of the integral end bent cap. The temporary geotextile wall is designed for a construction surcharge, remains in place and is aligned so the wall face functions as a form for the integral end bent cap backwall and wing walls.

Materials

Refer to Division 10 of the *Standard Specifications*.

Item	Section
Geotextiles	1056
Portland Cement Concrete	1000
Select Materials	1016
Subsurface Drainage Materials	1044
Welded Wire Reinforcement	1070-3

Provide Type 1 geotextile for separation geotextiles, Type 4a geotextile for under bridge approach slabs and Class B concrete for outlet pads. Use Class V or Class VI select material for Type 1 and 1A approach fills and the same aggregate type approved for the reinforced zone in the accepted MSE wall submittal for Type 2 and 2A approach fills. For MSE wall aggregate, reinforcement and connector materials, see the *Mechanically Stabilized Earth Retaining Walls* provision. Provide outlet pipes and fittings for subsurface drainage materials. Provide 1/4" hardware cloth with 1/4 inch openings constructed from 24 gauge wire.

For temporary geotextile walls, use welded wire reinforcement for welded wire facing and Type 5a geotextile for reinforcement geotextiles. Use Type 5a geotextile with lengths as shown in *Roadway Standard Drawing No. 423.02* or *423.04*.

Construction Methods

Excavate as necessary for approach fills and, if applicable, temporary geotextile walls in accordance with the contract. Ensure limits of approach fills are graded to drain as shown in the bridge approach fill *Roadway Standard Drawings*. For Type 1 and 1A approach fills in embankment fills, place and compact a temporary 1.5:1 (H:V) fill slope in accordance with *Roadway Standard Drawing* No. 423.01 or 423.02 and in accordance with Subarticle 235-3(B) and 235-3(C) of the *Standard Specifications*. Density testing is required within the temporary fill slope and additional more frequent density testing is also required for bridge approach embankments. Wait 3 days before cutting the slope back to complete the approach fill excavation. Use excavated material elsewhere on the project to form embankments, subgrades, or shoulders. If a slope for an approach fill is excavated to flatter than what is required for access or any other reason, that same slope is required for the entire approach fill excavation. Do not backfill overexcavations that extend outside the approach fill limits shown on the *Roadway Standard Drawings* with embankment soils. Instead, expand approach fill limits to include overexcavations.

Notify the Engineer when embankment fill placement and approach fill excavation is complete. Do not place separation geotextiles or aggregate until approach fill dimensions and embankment materials below and outside approach fills are approved.

For Type 2 approach fills, cast MSE wall reinforcement or connectors into end bent cap backwalls within 3 inches of locations shown in the accepted MSE wall submittals. Install MSE wall reinforcement with the orientation, dimensions and number of layers shown in the accepted MSE wall submittals. If a Type 2 approach fill is designed with geogrid reinforcement embedded in an end bent cap, cut geogrids to the required lengths and after securing ends of geogrids in place, reroll and rewrap portions of geogrids not embedded in the cap to protect geogrids from damage. Before placing aggregate over any MSE wall geosynthetic reinforcement, pull reinforcement taut so that it is in tension and free of kinks, folds, wrinkles or creases.

For Type 1 and 1A approach fills, place pipe sleeves in wing walls so water drains towards outlets. Use sleeves that can withstand wing wall loads. Insert outlet pipes into pipe sleeves to direct water towards outlets. Attach hardware cloth in front of the outlet pipe at the wing. Connect outlet pipes and fittings with solvent cement in accordance with Article 815-3 of the *Standard Specifications* and place outlet pads in accordance with *Roadway Standard Drawing* No. 815.03.

Attach separation geotextiles to end bent cap backwalls and wing walls with adhesives, tapes or other approved methods. Overlap adjacent geotextiles of the same type at least 18 inches. Cover select material or aggregate with Type 4a geotextile at an elevation 6 inches below the bridge approach slab. Hold geotextiles in place with wire staples or anchor pins as needed. Contact the Engineer when existing or future obstructions such as foundations, pavements, pipes, inlets or utilities will interfere with geotextiles or MSE wall reinforcement.

For Type 1A and 2A approach fills, install temporary geotextile walls as shown in *Roadway Standard Drawing* No. 423.02 or 423.04. At the Contractor's option, construct the bottom portion of integral end bents before temporary geotextile walls as shown in the plans. Erect and

set welded wire facing for temporary geotextile walls so facing functions as a form for the integral end bent cap backwall. Place welded wire facing adjacent to each other in the horizontal and vertical directions to completely cover the temporary geotextile wall face. Stagger welded wire facing to create a running bond by centering facing over joints in the row below. Wrap reinforcement geotextiles at the wall face in accordance with *Roadway Standard Drawing* No. 423.02 or 423.04 and cover geotextiles with at least 3 inches of select material or aggregate. Place layers of reinforcement geotextiles within 3 inches of locations shown in *Roadway Standard Drawing* No. 423.02 or 423.04. Install reinforcement geotextiles with the direction shown in *Roadway Standard Drawing* No. 423.02 or 423.04. Orient overlapping seams in reinforcement geotextiles perpendicular to the integral end bent cap backwall. Do not overlap reinforcement geotextiles so seams are parallel to the wall face. Before placing select material or aggregate over reinforcement geotextiles, pull geotextiles taut so they are in tension and free of kinks, folds, wrinkles or creases. Temporary geotextile walls are designed for a surcharge pressure in accordance with *Roadway Standard Drawing* No. 423.02 or 423.04. If loads from construction equipment will be more than what the wall is designed for, contact the Engineer before positioning equipment on top of temporary geotextile walls.

Place select material or aggregate in 6 inch to 8 inch thick lifts. Compact fine aggregate for Type 2 and 2A approach fills in accordance with Subarticle 235-3(C) of the *Standard Specifications* except compact fine aggregate to a density of at least 98%. Compact select material for Type 1 and 1A approach fills and coarse aggregate for Type 2 and 2A approach fills with at least 4 passes of a trench roller in a direction parallel to the end bent cap backwall. Do not displace or damage geosynthetics or MSE wall reinforcement when placing and compacting select material or aggregate. End dumping directly on geosynthetics is not permitted. Do not operate heavy equipment on geosynthetics until they are covered with at least 8 inches of select material or aggregate. Replace any damaged geosynthetics to the satisfaction of the Engineer. When approach fills extend beyond bridge approach slabs, wrap Type 4a geotextiles over select material or aggregate and back under approach slabs as shown in *Roadway Standard Drawing* No. 423.03 or 423.04.

Measurement and Payment

Type 1 and 1A approach fills will be paid for at the contract lump sum price for *Type 1 Bridge Approach Fill, Station _____* and Type 2 and 2A approach fills will be paid for at the contract lump sum price for *Type 2 Bridge Approach Fill, Station _____*. The lump sum price for each approach fill will be full compensation for providing labor, tools, equipment and approach fill materials, excavating, backfilling, hauling and removing excavated materials, installing wall facing, geotextiles and outlets, compacting backfill and supplying select material, aggregate, geotextiles, pipe sleeves, outlet pipes and pads and any incidentals necessary to construct approach fills behind bridge end bents.

Compensation for the material placed within the temporary 1.5:1 (H:V) fill slopes will be made in accordance with Section 225, 226, or 230 of the *Standard Specifications*. The cost of removal, including excavating, hauling, placement, and compaction of the material elsewhere on or off the project will be included in the contract lump sum price for *Type 1 Bridge Approach Fill, Station _____*.

The contract lump sum price for *Type 2 Bridge Approach Fill, Station _____* will also be full

compensation for supplying and connecting MSE wall reinforcement to end bent caps but not designing MSE wall reinforcement and connectors. The cost of designing reinforcement and connectors for Type 2 approach fills behind bridge end bents with MSE abutment walls will be incidental to the contract unit price for *MSE Retaining Wall No.* _____.

Payment will be made under:

Pay Item	Pay Unit
Type 1 Bridge Approach Fill, Station _____	Lump Sum
Type 2 Bridge Approach Fill, Station _____	Lump Sum

PRICE ADJUSTMENT - ASPHALT BINDER FOR PLANT MIX:

(11-21-00)(Rev. 1-16-24)

620

SP6 R25

Price adjustments for asphalt binder for plant mix will be made in accordance with Section 620 of the *Standard Specifications*.

The base price index for asphalt binder for plant mix is \$ **591.88** per ton.

This base price index represents an average of F.O.B. selling prices of asphalt binder at supplier's terminals on **March 1, 2024**.

FINAL SURFACE TESTING NOT REQUIRED:

(5-18-04) (Rev. 2-16-16)

610

SP6 R45

Final surface testing is not required on this project in accordance with Section 610-13, *Final Surface Testing and Acceptance*.

MODIFIED CONCRETE FLUME WITH CONCRETE OUTLET:

(3-19-96)(Rev. 1-16-24)

825

SP8 R10

At locations shown in the plans, construct concrete flumes, concrete curb, and apron in accordance with the details in the plans. Use materials meeting the requirements of Section 825 of the *Standard Specifications* except that the concrete must be Class B or of higher compressive strength.

Each concrete flume, concrete curb, and apron completed and accepted will be paid at the contract unit price per each for *Modified Concrete Flume*. Such price and payment will be full compensation for all materials, labor, equipment, tools, removing and disposing of the temporary slope drains, and any other incidentals necessary to complete the work satisfactorily.

The concrete curb and ditch outside the pay limits of the apron will be measured and paid in accordance with Section 846 and 850 of the *Standard Specifications*.

Payment will be made under:

Pay Item	Pay Unit
Modified Concrete Flume	Each

6" CONCRETE TRUCK APRON:**Description**

Construct 6" Concrete Truck Apron in accordance with the plans and as directed by the Engineer.

Materials

Concrete shall be Class AA Concrete meeting the requirements of Section 1000 of the *2024 Standard Specifications*.

Wire mesh reinforcement shall be 6x6-W4xW4 welded wire fabric meeting the requirements of Section 1070 of the 2018 Standard Specifications. The wire mesh reinforcement shall be centered in the 6" slab.

Construction Methods

Joint spacing for the aprons shall be constructed as directed by the Engineer.

Measurement and Payment

6" Concrete Truck Apron will be measured and paid for in square yards of 6" Concrete Truck Apron that has been completed and accepted. Such price and payment will be full compensation for all work of constructing the jointed concrete truck apron, including but not limited to excavating and backfilling, furnishing, and placing concrete, constructing joints, and sealing the concrete.

Pay Item**Pay Unit**

6" Concrete Truck Apron

Square Yard

IMPACT ATTENUATOR UNITS, TYPE TL-3:

(4-20-04)(Rev. 10-17-23)

SP8 R75

Description

Furnish and install impact attenuator units and any components necessary to connect the impact attenuator units in accordance with the manufacturer's requirement, the details in the plans and at locations shown in the plans.

Materials

Furnish attenuator units listed on the NCDOT APL. Units shall not be modified by the manufacturer and installer once approved and on the NCDOT APL.

Prior to installation the Contractor shall submit to the Engineer certified working drawings and assembling instructions from the manufacturer for each impact attenuator unit in accordance with Article 105-2 of the *Standard Specifications*.

Construction Methods

Perform installation in accordance with the plans and details and assembling instructions furnished by the manufacturer.

Measurement and Payment

Impact Attenuator Unit, Type TL-3 will be measured and paid at the contract unit price per each. Such prices and payment will be full compensation for all work covered by this provision including, but not limited to, furnishing, installing and all incidentals necessary to complete the work.

Payment will be made under:

Pay Item	Pay Unit
Impact Attenuator Units, Type TL-3	Each

FOUNDATIONS AND ANCHOR ROD ASSEMBLIES FOR METAL POLES:

(1-17-12)(Rev. 1-16-24)

9, 14, 17

SP9 R05

Description

Foundations for metal poles include foundations for signals, cameras, overhead and dynamic message signs (DMS) and high mount and light standards supported by metal poles or upright trusses. Foundations consist of footings with pedestals and drilled piers with or without grade beams or wings. Anchor rod assemblies consist of anchor rods (also called anchor bolts) with nuts and washers on the exposed ends of rods and nuts and a plate or washers on the other ends of rods embedded in the foundation.

Construct concrete foundations with the required resistances and dimensions and install anchor rod assemblies in accordance with the contract and accepted submittals. Construct drilled piers consisting of cast-in-place reinforced concrete cylindrical sections in excavated holes. Provide temporary casings or polymer slurry as needed to stabilize drilled pier excavations. Use a prequalified Drilled Pier Contractor to construct drilled piers for metal poles. Define "excavation" and "hole" as a drilled pier excavation and "pier" as a drilled pier.

This provision does not apply to foundations for signal pedestals; see Section 1743 of the *Standard Specifications* and Roadway Standard Drawing No. 1743.01.

Materials

Refer to the *Standard Specifications*.

Item	Section
Conduit	1091-3
Grout, Type 2	1003
Polymer Slurry	411-2(B)(2)
Portland Cement Concrete	1000
Reinforcing Steel	1070
Rollers and Chairs	411-2(C)
Temporary Casings	411-2(A)

Provide Type 3 material certifications in accordance with Article 106-3 of the *Standard Specifications* for conduit, rollers, chairs and anchor rod assemblies. Store steel materials on blocking at least 12" above the ground and protect it at all times from damage; and when placing in the work make sure it is free from dirt, dust, loose mill scale, loose rust, paint, oil or other foreign materials. Load, transport, unload and store foundation and anchor rod assembly materials so materials are kept clean and free of damage. Bent, damaged or defective materials will be rejected.

Use conduit type in accordance with the contract. Use Class A concrete for footings and pedestals, Class Drilled Pier concrete for drilled piers and Class AA concrete for grade beams and wings including portions of drilled piers above bottom of wings elevations. Corrugated temporary casings may be accepted at the discretion of the Engineer. A list of approved polymer slurry products is available from:

connect.ncdot.gov/resources/Geological/Pages/Products.aspx

Provide anchor rod assemblies in accordance with the contract consisting of the following:

- (A) Straight anchor rods,
- (B) Heavy hex top and leveling nuts and flat washers on exposed ends of rods, and
- (C) Nuts and either flat plates or washers on the other ends of anchor rods embedded in foundations.

Do not use lock washers. Use steel anchor rods, nuts and washers that meet ASTM F1554 for Grade 55 rods and Grade A nuts. Use steel plates and washers embedded in concrete with a thickness of at least 1/4". Galvanize anchor rods and exposed nuts and washers in accordance with Article 1076-4 of the *Standard Specifications*. It is not necessary to galvanize nuts, plates and washers embedded in concrete.

Construction Methods

Install the required size and number of conduits in foundations in accordance with the plans and accepted submittals. Construct top of piers, footings, pedestals, grade beams and wings flat, level and within 1" of elevations shown in the plans or approved by the Engineer. Provide an Ordinary Surface finish in accordance with Subarticle 825-6(B) of the *Standard Specifications* for portions of foundations exposed above finished grade. Do not remove anchor bolt templates or pedestal or grade beam forms or erect metal poles or upright trusses onto foundations until concrete attains a compressive strength of at least 3,000 psi.

(A) Drilled Piers

Before starting drilled pier construction, hold a predrill meeting to discuss the installation, monitoring and inspection of the drilled piers. Schedule this meeting after the Drilled Pier Contractor has mobilized to the site. The Resident or Division Traffic Engineer, Contractor and Drilled Pier Contractor Superintendent will attend this predrill meeting.

Do not excavate holes, install piles or allow equipment wheel loads or vibrations within 20 ft of completed piers until 16 hours after Drilled Pier concrete reaches initial set.

Check for correct drilled pier alignment and location before beginning drilling. Check plumbness of holes frequently during drilling.

Construct drilled piers with the minimum required diameters shown in the plans. Install piers with tip elevations no higher than shown in the plans or approved by the Engineer.

Excavate holes with equipment of the sizes required to construct drilled piers. Depending on the subsurface conditions encountered, drilling through rock and boulders may be required. Do not use blasting for drilled pier excavations.

Contain and dispose of drilling spoils and waste concrete as directed and in accordance with Section 802 of the *Standard Specifications*. Drilling spoils consist of all materials and fluids removed from excavations.

If unstable, caving or sloughing materials are anticipated or encountered, stabilize holes with temporary casings and/or polymer slurry. Do not use telescoping temporary casings. If it becomes necessary to replace a temporary casing during drilling, backfill the excavation, insert a larger casing around the casing to be replaced or stabilize the excavation with polymer slurry before removing the temporary casing.

If temporary casings become stuck or the Contractor proposes leaving casings in place, temporary casings should be installed against undisturbed material. Unless otherwise approved, do not leave temporary casings in place for mast arm poles and cantilever signs. The Engineer will determine if casings may remain in place. If the Contractor proposes leaving temporary casings in place, do not begin drilling until a casing installation method is approved.

Use polymer slurry and additives to stabilize holes in accordance with the slurry manufacturer's recommendations. Provide mixing water and equipment suitable for polymer slurry. Maintain the required slurry properties at all times except for sand content.

Define a "sample set" as slurry samples collected from mid-height and within 2 ft of the bottom of holes. Take sample sets from excavations to test polymer slurry immediately after filling holes with slurry, at least every 4 hours thereafter and immediately before placing concrete. Do not place Drilled Pier concrete until both slurry samples from an excavation meet the required polymer slurry properties. If any slurry test results do not meet the requirements, the Engineer may suspend drilling until both samples from a sample set meet the required polymer slurry properties.

Remove soft and loose material from bottom of holes using augers to the satisfaction of the Engineer. Assemble rebar cages and place cages and Drilled Pier concrete in accordance with Subarticle 411-4(E) of the *Standard Specifications* except for the following:

- (1) Inspections for tip resistance and bottom cleanliness are not required,
- (2) Temporary casings may remain in place if approved, and
- (3) Concrete placement may be paused near the top of pier elevations for anchor rod assembly installation and conduit placement or
- (4) If applicable, concrete placement may be stopped at bottom of grade beam or wings elevations for grade beam or wing construction.

If wet placement of concrete is anticipated or encountered, do not place Drilled Pier concrete until a concrete placement procedure is approved. If applicable, temporary casings and fluids may be removed when concrete placement is paused or stopped in accordance with the exceptions above provided holes are stable. Remove contaminated concrete from exposed Drilled Pier concrete after removing casings and fluids. If holes are unstable, do not remove temporary casings until a procedure for placing anchor rod assemblies and conduit or constructing grade beams or wings is approved.

Use collars to extend drilled piers above finished grade. Remove collars after Drilled Pier concrete sets and round top edges of piers.

If drilled piers are questionable, pile integrity testing (PIT) and further investigation may be required in accordance with Article 411-5 of the *Standard Specifications*. A drilled pier will be considered defective in accordance with Subarticle 411-5(D) of the *Standard Specifications* and drilled pier acceptance is based in part on the criteria in Article 411-6 of the *Standard Specifications* except for the top of pier tolerances in Subarticle 411-6(C) of the *Standard Specifications*.

If a drilled pier is under further investigation, do not grout core holes, backfill around the pier or perform any work on the drilled pier until the Engineer accepts the pier. If the drilled pier is accepted, dewater and grout core holes and backfill around the pier with approved material to finished grade. If the Engineer determines a pier is unacceptable,

remediation is required in accordance with Article 411-6 of the *Standard Specifications*. No extension of completion date or time will be allowed for remediation of unacceptable drilled piers or post repair testing.

Permanently embed a plate in or mark top of piers with the pier diameter and depth, size and number of vertical reinforcing bars and the minimum compressive strength of the concrete mix at 28 days.

(B) Footings, Pedestals, Grade Beams and Wings

Excavate as necessary for footings, grade beams and wings in accordance with the plans, accepted submittals and Section 410 of the *Standard Specifications*. If unstable, caving or sloughing materials are anticipated or encountered, shore foundation excavations as needed with an approved method. Notify the Engineer when foundation excavation is complete. Do not place concrete or reinforcing steel until excavation dimensions and foundation material are approved.

Construct cast-in-place reinforced concrete footings, pedestals, grade beams and wings with the dimensions shown in the plans and in accordance with Section 825 of the *Standard Specifications*. Use forms to construct portions of pedestals and grade beams protruding above finished grade. Provide a chamfer with a 3/4" horizontal width for pedestal and grade beam edges exposed above finished grade. Place concrete against undisturbed soil or backfill and fill in accordance with Article 410-8 of the *Standard Specifications*. Proper compaction around footings and wings is critical for foundations to resist uplift and torsion forces.

(C) Anchor Rod Assemblies

Size anchor rods for design and the required projection above top of foundations. Determine required anchor rod projections from nut, washer and base plate thicknesses, the protrusion of 3 to 5 anchor rod threads above top nuts after tightening and the distance of one nut thickness between top of foundations and bottom of leveling nuts.

Protect anchor rod threads from damage during storage and installation of anchor rod assemblies. Before placing anchor rods in foundations, turn nuts onto and off rods past leveling nut locations. Turn nuts with the effort of one workman using an ordinary wrench without a cheater bar. Report any thread damage to the Engineer that requires extra effort to turn nuts.

Arrange anchor rods symmetrically about center of base plate locations as shown in the plans. Set anchor rod elevations based on required projections above top of foundations. Securely brace and hold rods in the correct position, orientation and alignment with a steel template. Do not weld to reinforcing steel, temporary casings or anchor rods.

Install top and leveling (bottom) nuts, washers and the base plate for each anchor rod assembly in accordance with the following procedure:

- (1) Turn leveling nuts onto anchor rods to a distance of one nut thickness between the top of foundation and bottom of leveling nuts. Place washers over anchor rods on top of leveling nuts.
- (2) Determine if nuts are level using a flat rigid template on top of washers. If necessary, lower leveling nuts to level the template in all directions or if applicable, lower nuts to tilt the template so the metal pole or upright truss will lean as shown in the plans. If leveling nuts and washers are not in full contact with the template, replace washers with galvanized beveled washers.
- (3) Verify the distance between the foundation and leveling nuts is no more than one nut thickness.
- (4) Place base plate with metal pole or upright truss over anchor rods on top of washers. High mount luminaires may be attached before erecting metal poles but do not attach cables, mast arms or trusses to metal poles or upright trusses at this time.
- (5) Place washers over anchor rods on top of base plate. Lubricate top nut bearing surfaces and exposed anchor rod threads above washers with beeswax, paraffin or other approved lubricant.
- (6) Turn top nuts onto anchor rods. If nuts are not in full contact with washers or washers are not in full contact with the base plate, replace washers with galvanized beveled washers.
- (7) Tighten top nuts to snug-tight with the full effort of one workman using a 12" wrench. Do not tighten any nut all at once. Turn top nuts in increments. Follow a star pattern cycling through each nut at least twice.
- (8) Repeat (7) for leveling nuts.
- (9) Replace washers above and below the base plate with galvanized beveled washers if the slope of any base plate face exceeds 1:20 (5%), any washer is not in firm contact with the base plate or any nut is not in firm contact with a washer. If any washers are replaced, repeat (7) and (8).
- (10) With top and leveling nuts snug-tight, mark each top nut on a corner at the intersection of 2 flats and a corresponding reference mark on the base plate. Mark top nuts and base plate with ink or paint that is not water-soluble. Use the turn-of-nut method for pretensioning. Do not pretension any nut all at once. Turn top nuts in increments for a total turn that meets the following nut rotation requirements:

NUT ROTATION REQUIREMENTS (Turn-of-Nut Pretensioning Method)	
Anchor Rod Diameter, inch	Requirement
$\leq 1 \frac{1}{2}$	1/3 turn (2 flats)
$> 1 \frac{1}{2}$	1/6 turn (1 flat)

Follow a star pattern cycling through each top nut at least twice.

- (11) Ensure nuts, washers and base plate are in firm contact with each other for each anchor rod. Cables, mast arms and trusses may now be attached to metal poles and upright trusses.
- (12) Between 4 and 14 days after pretensioning top nuts, use a torque wrench

calibrated within the last 12 months to check nuts in the presence of the Engineer. Completely erect mast arm poles and cantilever signs and attach any hardware before checking top nuts for these structures. Check that top nuts meet the following torque requirements:

TORQUE REQUIREMENTS	
Anchor Rod Diameter, inch	Requirement, ft-lb
7/8	180
1	270
1 1/8	380
1 1/4	420
≥ 1 1/2	600

If necessary, retighten top nuts in the presence of the Engineer with a calibrated torque wrench to within ± 10 ft-lb of the required torque. Do not overtighten top nuts.

- (13) Do not grout under base plate.

Measurement and Payment

Foundations and anchor rod assemblies for metal poles and upright trusses will be measured and paid for elsewhere in the contract.

No payment will be made for temporary casings that remain in drilled pier excavations. No payment will be made for PIT. No payment will be made for further investigation of defective piers. Further investigation of piers that are not defective will be paid as extra work in accordance with Article 104-7 of the *Standard Specifications*. No payment will be made for remediation of unacceptable drilled piers or post repair testing.

HIGH STRENGTH CONCRETE FOR DRIVEWAYS:

(11-21-00)(Rev. 1-16-24)

848

SP10 R02

Use high early strength concrete for all driveways shown in the plans and as directed by the Engineer. Provide high early strength concrete that meets the requirements of Article 1000-6 of the *Standard Specifications*.

Measurement and payment will be in accordance with Section 848 of the *Standard Specifications*.

TEMPORARY SHORING:

(2-20-07)(Rev. 1-16-24)

SP11 R02

Description

Temporary shoring includes cantilever, braced and anchored shoring and temporary mechanically stabilized earth (MSE) walls. Temporary shoring does not include trench boxes. At the Contractor's option, use any type of temporary shoring unless noted otherwise in the plans or as directed. Design and construct temporary shoring based on actual elevations and shoring dimensions in accordance with the contract and accepted submittals. Construct temporary shoring at locations shown in the plans and as directed. Temporary shoring is required to maintain traffic when a 2:1 (H:V) slope from the top of an embankment or bottom of an excavation will intersect the existing ground line less than 5 feet from the edge of pavement of an open travelway. This provision does not apply to pipe, inlet or utility installation unless noted otherwise in the plans.

Positive protection includes concrete barrier and temporary guardrail. Provide positive protection for temporary shoring at locations shown in the plans and as directed. Positive protection is required if temporary shoring is located in the clear zone in accordance with the *AASHTO Roadside Design Guide*.

(A) Cantilever and Braced Shoring

Cantilever shoring consists of steel sheet piles or H-piles with timber lagging. Braced shoring consists of sheet piles or H-piles with timber lagging and bracing such as beams, plates, walers, struts, rakers, etc. Define "piles" as sheet piles or H-piles.

(B) Anchored Shoring

Anchored shoring consists of sheet piles with walers or H-piles with timber lagging anchored with ground or helical anchors. Driven anchors may be accepted at the discretion of the Engineer. A ground anchor consists of a grouted steel bar or multi-strand tendon with an anchorage. A helical anchor consists of a lead section with a central steel shaft and at least one helix steel plate followed by extensions with only central shafts (no helixes) and an anchorage. Anchorages consist of steel bearing plates with washers and hex nuts for bars or steel wedge plates and wedges for strands. Use a prequalified Anchored Wall Contractor to install ground anchors. Define "anchors" as ground, helical or driven anchors.

(C) Temporary MSE Walls

Temporary MSE walls include temporary geosynthetic and wire walls. Define "temporary wall" as a temporary MSE wall and "Temporary Wall Vendor" as the vendor supplying the temporary MSE wall. Define "reinforcement" as geotextile, geogrid, geostrip, welded wire grid or metallic strip reinforcement.

Temporary geosynthetic walls consist of geotextiles or geogrids wrapped behind welded wire facing or geostrips connected to welded wire facing. Define "temporary geotextile wall" as a temporary geosynthetic wall with geotextile reinforcement, "temporary

geogrid wall” as a temporary geosynthetic wall with geogrid reinforcement and “temporary geostrip wall” as a temporary geosynthetic wall with geostrip reinforcement.

Temporary wire walls consist of welded wire grid or metallic strip reinforcement connected to welded wire facing. Define “Wire Wall Vendor” as the vendor supplying the temporary wire wall.

(D) Embedment

Define “embedment” for cantilever, braced and anchored shoring as the pile depth below the grade in front of shoring. Define “embedment” for temporary walls as the wall embedment below the grade at the wall face.

(E) Positive Protection

Define “unanchored or anchored portable concrete barrier” as portable concrete barrier (PCB) that meets *Roadway Standard Drawing* No. 1170.01. Define “concrete barrier” as unanchored or anchored PCB or an approved equal. Define “temporary guardrail” as temporary steel beam guardrail that meets *Roadway Standard Drawing* No. 862.02.

Materials

Refer to the *Standard Specifications*.

Item	Section
Concrete Barrier Materials	1170-2
Flowable Fill, Excavatable	1000-7
Geosynthetics	1056
Grout, Type 1	1003
Portland Cement	1024-1
Portland Cement Concrete	1000
Select Materials	1016
Steel Beam Guardrail Materials	862-2
Steel Plates	1072-2
Steel Sheet Piles and H-Piles	1084
Untreated Timber	1082-2
Water	1024-4
Welded Wire Reinforcement	1070-3

Provide Type 6 material certifications for shoring materials in accordance with Article 106-3 of the *Standard Specifications*. Use Class IV select material for temporary guardrail and Class A concrete that meets Article 450-2 of the *Standard Specifications* or Type 1 grout for drilled-in piles. Provide untreated timber with a thickness of at least 3 inches and a bending stress of at least 1,000 pounds per square inch for timber lagging. Provide steel bracing that meets ASTM A36.

(A) Shoring Backfill

Use Class II, Type 1, Class III, Class V or Class VI select material or material that meets AASHTO M 145 for soil classification A-2-4 with a maximum PI of 6 for shoring backfill except do not use A-2-4 soil for backfill around culverts.

(B) Anchors

Store anchor materials on blocking a minimum of 12 inches above the ground and protect it at all times from damage; and when placing in the work make sure it is free from dirt, dust, loose mill scale, loose rust, paint, oil or other foreign materials. Load, transport, unload and store anchor materials so materials are kept clean and free of damage. Bent, damaged or defective materials will be rejected.

(1) Ground Anchors

Use high-strength deformed steel bars that meet AASHTO M 275 or seven-wire strands that meet ASTM A886 or Article 1070-5 of the *Standard Specifications*. Splice bars in accordance with Article 1070-9 of the *Standard Specifications*. Do not splice strands. Use bondbreakers, spacers and centralizers that meet Article 6.3.5 of the *AASHTO LRFD Bridge Construction Specifications*.

Use neat cement grout that only contains cement and water with a water cement ratio of 0.4 to 0.5 which is approximately 5.5 gallons of water per 94 pounds of Portland cement. Provide grout with a compressive strength at 3 and 28 days of at least 1,500 and 4,000 psi, respectively.

(2) Helical Anchors

Use helical anchors with an ICC Evaluation Service, Inc. (ICC-ES) report. Provide couplers, thread bar adapters and bolts recommended by the Anchor Manufacturer to connect helical anchors together and to piles.

(3) Anchorages

Provide steel plates for bearing plates and steel washers, hex nuts, wedge plates and wedges recommended by the Anchor Manufacturer.

(C) Temporary Walls

(1) Welded Wire Facing

Use welded wire reinforcement for welded wire facing, struts and wires. For temporary wire walls, provide welded wire facing supplied by the Wire Wall Vendor or a manufacturer approved or licensed by the vendor. For temporary wire walls with separate reinforcement and facing components, provide connectors (e.g., bars, clamps, plates, etc.) and fasteners (e.g., bolts, nuts, washers, etc.) required by the Wire Wall Vendor.

(2) Geotextiles

Provide Type 2 geotextile for separation and retention geotextiles. Provide Type 5 geotextile for geotextile reinforcement with ultimate tensile strengths in accordance with the accepted submittals.

(3) Geogrid and Geostrip Reinforcement

Use geogrids with a roll width of at least 4 feet. Use geogrids for geogrid reinforcement and geostrips for geostrip reinforcement with an “approved” status code in accordance with the NCDOT Geosynthetic Reinforcement Evaluation Program. The list of approved geogrids and geostrips is available from:

connect.ncdot.gov/resources/Geological/Pages/Products.aspx

Provide geogrids and geostrips with design strengths in accordance with the accepted submittals. Geogrids and geostrips are approved for short-term design strengths (3-year design life) in the machine direction (MD) and cross-machine direction (CD) based on material type. Define material type from the website above for shoring backfill as follows:

Material Type	Shoring Backfill
Borrow	A-2-4 Soil
Fine Aggregate	Class II, Type 1 or Class III Select Material
Coarse Aggregate	Class V or VI Select Material

(4) Welded Wire Grid and Metallic Strip Reinforcement

Provide welded wire grid and metallic strip reinforcement supplied by the Wire Wall Vendor or a manufacturer approved or licensed by the vendor. Use welded wire grid reinforcement (“mesh”, “mats” and “ladders”) that meet Article 1070-3 of the *Standard Specifications* and metallic strip reinforcement (“straps”) that meet ASTM A572 or A1011.

Preconstruction Requirements

(A) Concrete Barrier

Define “clear distance” behind concrete barrier as the horizontal distance between the barrier and edge of pavement. The minimum required clear distance for concrete barrier is shown in the plans. At the Contractor’s option or if the minimum required clear distance is not available, set concrete barrier next to and up against traffic side of temporary shoring except for barrier above temporary walls. Concrete barrier with the minimum required clear distance is required above temporary walls.

(B) Temporary Guardrail

Define “clear distance” behind temporary guardrail as the horizontal distance between guardrail posts and temporary shoring. At the Contractor’s option or if clear distance for cantilever, braced and anchored shoring is less than 4 feet, attach guardrail to traffic side

of shoring as shown in the plans. Place ABC in clear distance and around guardrail posts instead of pavement. Do not use temporary guardrail above temporary walls.

(C) Temporary Shoring Designs

Before beginning temporary shoring design, survey existing ground elevations in the vicinity of shoring locations to determine actual design heights (H). Submit PDF files of working drawings and design calculations for temporary shoring designs in accordance with Article 105-2 of the *Standard Specifications*. Submit working drawings showing plan views, shoring profiles, typical sections and details of temporary shoring design and construction sequence. Do not begin shoring construction until a design submittal is accepted.

Have cantilever and braced shoring designed, detailed and sealed by an engineer licensed in the state of North Carolina. Use a prequalified Anchored Wall Design Consultant to design anchored shoring. Provide anchored shoring designs sealed by a Design Engineer approved as a Geotechnical Engineer (key person) for an Anchored Wall Design Consultant. Include details in anchored shoring working drawings of anchor locations and lock-off loads, unit grout/ground bond strengths for ground anchors or minimum installation torque and torsional strength rating for helical anchors and if necessary, obstructions extending through shoring or interfering with anchors. Include details in the anchored shoring construction sequence of pile and anchor installation, excavation and anchor testing.

Provide temporary wall designs sealed by a Design Engineer licensed in the state of North Carolina and employed or contracted by the Temporary Wall Vendor. Include details in temporary wall working drawings of geotextile and reinforcement types, locations and directions and obstructions extending through walls or interfering with reinforcement.

(1) Soil Parameters

Design temporary shoring for the assumed soil parameters and groundwater or flood elevations shown in the plans. Assume the following soil parameters for shoring backfill:

(a) Unit weight (γ) = 120 pcf,

(b)	Friction Angle (ϕ)	Shoring Backfill
	30°	A-2-4 Soil
	34°	Class II, Type 1 or Class III Select Material
	38°	Class V or VI Select Material

(c) Cohesion (c) = 0 psf.

(2) Traffic Surcharge

Design temporary shoring for a traffic surcharge of 250 pounds per square foot if

traffic will be above and within H of shoring. This traffic surcharge does not apply to construction traffic. Design temporary shoring for any construction surcharge if construction traffic will be above and within H of shoring. Design temporary shoring for a traffic (live load) surcharge in accordance with Article 11.5.6 of the *AASHTO LRFD Bridge Design Specifications*.

(3) Cantilever, Braced and Anchored Shoring Designs

Use shoring backfill for fill sections and voids between cantilever, braced and anchored shoring and the critical failure surface. Use concrete or Type 1 grout for embedded portions of drilled-in H-piles. Do not use drilled-in sheet piles.

Define “top of shoring” for cantilever, braced and anchored shoring as where the grade intersects the back of sheet piles or H-piles and timber lagging. Design cantilever, braced and anchored shoring for a traffic impact load of 2,000 pounds per foot applied 18 inches above top of shoring if concrete barrier is above and next to shoring or temporary guardrail is above and attached to shoring. Extend cantilever, braced and anchored shoring at least 32 inches above top of shoring if shoring is designed for traffic impact. Otherwise, extend shoring at least 6 inches above top of shoring.

Design cantilever, braced and anchored shoring for a maximum deflection of 3 inches if the horizontal distance to the closest edge of pavement or structure is less than H. Otherwise, design shoring for a maximum deflection of 6 inches. Design cantilever and braced shoring in accordance with the plans and *AASHTO Guide Design Specifications for Bridge Temporary Works*.

Design anchored shoring in accordance with the plans and Article 11.9 of the *AASHTO LRFD Bridge Design Specifications*. Use a resistance factor of 0.80 for tensile resistance of anchors with bars, strands or shafts. Extend the unbonded length for ground anchors and the shallowest helix for helical anchors at least 5 feet behind the critical failure surface. Do not extend anchors beyond right-of-way or easement limits. If existing or future obstructions such as foundations, guardrail posts, pavements, pipes, inlets or utilities will interfere with anchors, maintain a clearance of at least 6 inches between obstructions and anchors.

(4) Temporary Wall Designs

Use shoring backfill in the reinforced zone of temporary walls. Separation geotextiles are required between shoring backfill and backfill, natural ground or culverts along the sides of the reinforced zone perpendicular to the wall face. For Class V or VI select material in the reinforced zone, separation geotextiles are also required between shoring backfill and backfill or natural ground on top of and at the back of the reinforced zone.

Design temporary walls in accordance with the plans and Article 11.10 of the *AASHTO LRFD Bridge Design Specifications*. Embed temporary walls at least 18 inches except for walls on structures or rock as determined by the Engineer. Use

a uniform reinforcement length throughout the wall height of at least $0.7H$ or 6 feet, whichever is longer. Extend the reinforced zone at least 6 inches beyond end of reinforcement. Do not locate the reinforced zone outside right-of-way or easement limits.

Use the simplified method for determining maximum reinforcement loads in accordance with the AASHTO LRFD specifications. For geotextile reinforcement, use geotextile properties approved by the Department or default values in accordance with the AASHTO LRFD specifications. For geogrid and geostrip reinforcement, use approved geosynthetic reinforcement properties available from the website shown elsewhere in this provision. Use geosynthetic properties for the direction reinforcement will be installed, a 3-year design life and shoring backfill to be used in the reinforced zone.

Do not use more than 4 different reinforcement strengths for each temporary geosynthetic wall. Design temporary geotextile walls for a reinforcement coverage ratio (R_c) of 1.0. For temporary geogrid walls with an R_c of less than 1.0, use a maximum horizontal clearance between geogrids of 3 feet and stagger reinforcement so geogrids are centered over gaps in the reinforcement layer below.

For temporary geosynthetic walls, use “L” shaped welded wire facing with 18 to 24 inch long legs. Locate geosynthetic reinforcement so reinforcement layers are at the same level as the horizontal legs of welded wire facing. Use vertical reinforcement spacing equal to facing height. Wrap geotextile or geogrid reinforcement behind welded wire facing and extend reinforcement at least 3 feet back behind facing into shoring backfill. Attach geostrip reinforcement to welded wire facing with a connection approved by the Department.

For temporary wire walls with separate reinforcement and facing components, attach welded wire grid or metallic strip reinforcement to welded wire facing with a connection approved by the Department. For temporary geogrid, geostrip and wire walls, retain shoring backfill at welded wire facing with retention geotextiles and extend geotextiles at least 3 feet back behind facing into backfill.

(D) Preconstruction Meeting

The Engineer may require a shoring preconstruction meeting to discuss the construction, inspection and testing of the temporary shoring. If required and if this meeting occurs before all shoring submittals have been accepted, additional preconstruction meetings may be required before beginning construction of temporary shoring without accepted submittals. The Resident, District or Bridge Maintenance Engineer, Area Construction Engineer, Geotechnical Operations Engineer, Contractor and Shoring Contractor Superintendent will attend preconstruction meetings.

Construction Methods

Control drainage during construction in the vicinity of shoring. Direct run off away from shoring and shoring backfill. Contain and maintain backfill and protect material from erosion.

Install positive protection in accordance with the contract and accepted submittals. Use PCB in accordance with Section 1170 of the *Standard Specifications* and *Roadway Standard Drawing* No. 1170.01. Use temporary guardrail in accordance with Section 862 of the *Standard Specifications* and *Roadway Standard Drawing* Nos. 862.01, 862.02 and 862.03.

(A) Tolerances

Construct shoring with the following tolerances:

- (1) Horizontal wires of welded wire facing are level in all directions,
- (2) Shoring location is within 6 inches of horizontal and vertical alignment shown in the accepted submittals, and
- (3) Shoring plumbness (batter) is not negative and within 2 degrees of vertical.

(B) Cantilever, Braced and Anchored Shoring Installation

If overexcavation behind cantilever, braced or anchored shoring is shown in the accepted submittals, excavate before installing piles. Otherwise, install piles before excavating for shoring. Install cantilever, braced or anchored shoring in accordance with the construction sequence shown in the accepted submittals. Remove piles and if applicable, timber lagging when shoring is no longer needed.

(1) Pile Installation

Install piles with the minimum required embedment and extension in accordance with Subarticles 450-3(D) and 450-3(E) of the *Standard Specifications* except that a pile driving equipment data form is not required. Piles may be installed with a vibratory hammer as approved by the Engineer.

Do not splice sheet piles. Use pile excavation to install drilled-in H-piles. After filling holes with concrete or Type 1 grout to the elevations shown in the accepted submittals, remove any fluids and fill remaining portions of holes with flowable fill. Cure concrete or grout at least 7 days before excavating.

Notify the Engineer if refusal is reached before pile excavation or driven piles attain the minimum required embedment. When this occurs, a revised design submittal may be required.

(2) Excavation

Excavate in front of piles from the top down in accordance with the accepted

submittals. For H-piles with timber lagging and braced and anchored shoring, excavate in staged horizontal lifts with a maximum height of 5 feet. Remove flowable fill and material in between H-piles as needed to install timber lagging. Position lagging with at least 3 inches of contact in the horizontal direction between the lagging and pile flanges. Do not excavate the next lift until timber lagging for the current lift is installed and if applicable, bracing and anchors for the current lift are accepted. Backfill behind cantilever, braced or anchored shoring with shoring backfill.

(3) Anchor Installation

If applicable, install foundations located behind anchored shoring before installing anchors. Fabricate and install ground anchors in accordance with the accepted submittals, Articles 6.4 and 6.5 of the *AASHTO LRFD Bridge Construction Specifications* and the following unless otherwise approved:

- (a) Materials in accordance with this provision are required instead of materials conforming to Articles 6.4 and 6.5.3 of the AASHTO LRFD Specifications,
- (b) Encapsulation-protected ground anchors in accordance with Article 6.4.1.2 of the AASHTO LRFD specifications are not required, and
- (c) Corrosion protection for unbonded lengths of ground anchors and anchorage covers are not required.
- (d) Mix and place neat cement grout in accordance with Subarticles 1003-5, 1003-6 and 1003-7 of the *Standard Specifications*. Measure grout temperature, density and flow during grouting with at least the same frequency grout cubes are made for compressive strength. Perform density and flow field tests in the presence of the Engineer in accordance with American National Standards Institute/American Petroleum Institute Recommended Practice 13B-1 (Section 4, Mud Balance) and ASTM C939 (Flow Cone), respectively.

Install helical anchors in accordance with the accepted submittals and Anchor Manufacturer's instructions. Measure torque during installation and do not exceed the torsional strength rating of the helical anchor. Attain the minimum required installation torque and penetration before terminating anchor installation. When replacing a helical anchor, embed last helix of the replacement anchor at least 3 helix plate diameters past the location of the first helix of the previous anchor.

(4) Anchor Testing

Proof test and lock-off anchors in accordance with the accepted submittals and Article 6.5.5 of the *AASHTO LRFD Bridge Construction Specifications* except for the acceptance criteria in Article 6.5.5.5. For the AASHTO LRFD specifications,

“ground anchor” refers to a ground or helical anchor and “tendon” refers to a bar, strand or shaft.

(a) Anchor Acceptance

Anchor acceptance is based in part on the following criteria.

- (i) For ground and helical anchors, total movement is less than 0.04 inches between the 1 and 10 minute readings or less than 0.08 inches between the 6 and 60 minute readings.
- (ii) For ground anchors, total movement at maximum test load exceeds 80% of the theoretical elastic elongation of the unbonded length.

(b) Anchor Test Results

Submit PDF files of anchor test records including movement versus load plots for each load increment within 24 hours of completing each row of anchors. The Engineer will review the test records to determine if the anchors are acceptable.

If the Engineer determines an anchor is unacceptable, revise the anchor design or installation methods. Submit a revised anchored shoring design for acceptance and provide an acceptable anchor with the revised design or installation methods. If required, replace the anchor or provide additional anchors with the revised design or installation methods.

(C) Temporary Wall Installation

Excavate as necessary for temporary walls in accordance with the plans and accepted submittals. If applicable, install foundations located in the reinforced zone before placing shoring backfill or reinforcement unless otherwise approved. Notify the Engineer when foundation excavation is complete. Do not place shoring backfill or reinforcement until excavation dimensions and foundation material are approved.

Erect welded wire facing so the wall position is as shown in the plans and accepted submittals. Set welded wire facing adjacent to each other in the horizontal and vertical direction to completely cover the wall face with facing. Stagger welded wire facing to create a running bond by centering facing over joints in the row below.

Attach geostrip reinforcement to welded wire facing and wrap geotextile reinforcement and retention geotextiles behind welded wire facing as shown in the plans and accepted submittals. Cover geotextiles with at least 3" of shoring backfill. Overlap adjacent geotextile reinforcement and retention and separation geotextiles at least 18 inches with seams oriented perpendicular to the wall face. Hold geotextiles in place with wire staples or anchor pins as needed.

Place reinforcement within 3 inches of locations shown in the plans and accepted submittals. Before placing shoring backfill, pull geosynthetic reinforcement taut so it is

in tension and free of kinks, folds, wrinkles or creases. Install reinforcement with the direction shown in the plans and accepted submittals. For temporary wire walls with separate reinforcement and facing components, attach welded wire grid or metallic strip reinforcement to welded wire facing as shown in the accepted submittals. Do not splice or overlap reinforcement so seams are parallel to the wall face. Contact the Engineer when unanticipated existing or future obstructions such as foundations, pavements, pipes, inlets or utilities will interfere with reinforcement.

Place shoring backfill in the reinforced zone in 8 to 10 inch thick lifts. Compact A-2-4 soil and Class II, Type 1 and Class III select material in accordance with Subarticle 235-3(C) of the *Standard Specifications*. Use only hand operated compaction equipment to compact backfill within 3 feet of welded wire facing. At a distance greater than 3 feet, compact shoring backfill with at least 4 passes of an 8 to 10 ton vibratory roller in a direction parallel to the wall face. Smooth wheeled or rubber tired rollers are also acceptable for compacting backfill. Do not use sheepsfoot, grid rollers or other types of compaction equipment with feet. Do not displace or damage reinforcement when placing and compacting shoring backfill. End dumping directly on geosynthetics is not permitted. Do not operate heavy equipment on reinforcement until it is covered with at least 8 inches of shoring backfill. Replace any damaged reinforcement to the satisfaction of the Engineer.

Backfill for temporary walls outside the reinforced zone in accordance with Article 410-8 of the *Standard Specifications*. Bench temporary walls into the sides of excavations where applicable. For temporary geosynthetic walls with top of wall within 5 feet of finished grade, remove top facing and incorporate top reinforcement layer into fill when placing fill in front of wall. Temporary walls remain in place permanently unless otherwise required.

Measurement and Payment

Temporary Shoring will be measured and paid in square feet. Temporary walls will be measured as the square feet of exposed wall face area. Cantilever, braced or anchored shoring will be measured as the square feet of exposed shoring face area with the shoring height equal to the difference between the top and bottom of shoring elevations. Define “top of shoring” as where the grade intersects the back of sheet piles or H-piles and timber lagging. Define “bottom of shoring” as where the grade intersects front of sheet piles or H-piles and timber lagging. No measurement will be made for any embedment, shoring extension above top of shoring or pavement thickness above temporary walls.

The contract unit price for *Temporary Shoring* will be full compensation for providing shoring designs, submittals and materials, excavating, backfilling, hauling and removing excavated materials and supplying all labor, tools, equipment and incidentals necessary to construct temporary shoring.

No payment will be made for temporary shoring not shown in the plans or required by the Engineer including shoring for OSHA reasons or the Contractor’s convenience. No value engineering proposals will be accepted based solely on revising or eliminating shoring locations shown in the plans or estimated quantities shown in the bid item sheets as a result of actual field

measurements or site conditions.

PCB will be measured and paid in accordance with Article 1170-4 of the *Standard Specifications*. No additional payment will be made for anchoring PCB for temporary shoring. Costs for anchoring PCB will be incidental to temporary shoring.

Temporary guardrail will be measured and paid for in accordance with Article 862-6 of the *Standard Specifications*.

Payment will be made under:

Pay Item	Pay Unit
Temporary Shoring	Square Foot

CONES:

(3-19-24) 1135 SP11 R35

Revise the *Standard Specifications* as follows:

Page 11-11, Article 1135-3 CONSTRUCTION METHODS, lines 19-20, delete the third sentence of the first paragraph, “Do not use cones in the upstream taper of lane or shoulder closures for multi-lane roadways.”.

WATTLE DEVICES:

(1-1-24) 1642 SP16 R01

Page 16-23, Subarticle 1642-2(B) Wattle, lines 10-12, delete and replace with the following:

(B) Wattle and Wattle Barrier

Wattles shall meet Table 1642-1.

TABLE 1642-1	
100% CURLED WOOD (EXCELSIOR) FIBERS - WATTLE	
Property	Property Value
Minimum Diameter	12 inches
Minimum Density	2.5 pcf +/- 10%
Net Material	Synthetic
Net Openings	1 inch x 1 inch
Net Configuration	Totally Encased
Minimum Weight	20 lb +/- 10% per 10 foot length

Coir Fiber Wattles shall meet Table 1642-2.

TABLE 1642-2	
100% COIR (COCONUT) FIBERS WATTLE	
Property	Property Value
Minimum Diameter	12 inches
Minimum Density	3.5 pcf +/- 10%
Net Material	Coir Fiber
Net Openings	2 inch x 2 inch
Net Strength	90 lb
Minimum Weight	2.6 pcf +/- 10%

Wattle Barriers shall meet Table 1642-3.

TABLE 1642-3	
100% CURLED WOOD (EXCELSIOR) FIBERS – WATTLE BARRIER	
Property	Property Value
Minimum Diameter	18 inches
Minimum Density	2.9 pcf +/- 10%
Net Material	Synthetic
Net Openings	1 inch x 1 inch
Net Configuration	Totally Encased
Minimum Weight	5 pcf +/- 10%

Coir Fiber Wattle Barriers shall meet Table 1642-4.

TABLE 1642-4	
100% COIR (COCONUT) FIBERS WATTLE BARRIER	
Property	Property Value
Minimum Diameter	18 inches
Minimum Density	5 pcf +/- 10%
Net Material	Coir Fiber
Net Openings	2 inch x 2 inch
Net Strength	90 lb
Minimum Weight	10 pcf +/- 10%

Pages 16-24 & 16-25, Article 1642-5 MEASUREMENT AND PAYMENT, lines 42-47 & lines 1-2, delete and replace with the following:

Wattle will be measured and paid for by the actual number of linear feet of wattles which are installed and accepted. Such price and payment will be full compensation for all work covered by this section, including, but not limited to, furnishing all materials, labor, equipment and incidentals necessary to install the *Wattle*.

Coir Fiber Wattles will be measured and paid for by the actual number of linear feet of coir fiber wattles which are installed and accepted. Such price and payment will be full compensation for all work covered by this section, including, but not limited to, furnishing all materials, labor, equipment and incidentals necessary to install the *Coir Fiber Wattles*.

Wattle Barrier will be measured and paid as the actual number of linear feet of wattle barrier installed and accepted. Such price and payment will be full compensation for all work covered by this provision, including, but not limited to, furnishing all materials, labor, equipment and incidentals necessary to install the *Wattle Barrier*.

Coir Fiber Wattle Barrier will be measured and paid as the actual number of linear feet of coir fiber wattle barrier installed and accepted. Such price and payment will be full compensation for all work covered by this provision, including, but not limited to, furnishing all materials, labor, equipment and incidentals necessary to install the *Coir Fiber Wattle Barrier*.

Page 16-25, Article 1642-5 MEASUREMENT AND PAYMENT, after line 9, delete and replace “ ___ Wattle Check” with “Wattle”.

Page 16-25, Article 1642-5 MEASUREMENT AND PAYMENT, after line 9, delete and replace “ ___ Wattle Barrier” with “Wattle Barrier”.

Page 16-25, Article 1642-5 MEASUREMENT AND PAYMENT, after line 9, add the following:

Pay Item	Pay Unit
Coir Fiber Wattle	Linear Foot
Coir Fiber Wattle Barrier	Linear Foot

STANDARD SPECIAL PROVISION
AVAILABILITY OF FUNDS – TERMINATION OF CONTRACTS

(5-20-08)(Rev. 1-16-24)

Z-2

General Statute 143C-6-11. (h) Highway Appropriation is hereby incorporated verbatim in this contract as follows:

(h) Amounts Encumbered. – Transportation project appropriations may be encumbered in the amount of allotments made to the Department of Transportation by the Director for the estimated payments for transportation project contract work to be performed in the appropriation fiscal year. The allotments shall be multiyear allotments and shall be based on estimated revenues and shall be subject to the maximum contract authority contained in *General Statute 143C-6-11(c)*. Payment for transportation project work performed pursuant to contract in any fiscal year other than the current fiscal year is subject to appropriations by the General Assembly. Transportation project contracts shall contain a schedule of estimated completion progress, and any acceleration of this progress shall be subject to the approval of the Department of Transportation provided funds are available. The State reserves the right to terminate or suspend any transportation project contract, and any transportation project contract shall be so terminated or suspended if funds will not be available for payment of the work to be performed during that fiscal year pursuant to the contract. In the event of termination of any contract, the contractor shall be given a written notice of termination at least 60 days before completion of scheduled work for which funds are available. In the event of termination, the contractor shall be paid for the work already performed in accordance with the contract specifications.

Payment will be made on any contract terminated pursuant to the special provision in accordance with Subarticle 108-13(D) of the *Standard Specifications*.

STANDARD SPECIAL PROVISION
NCDOT GENERAL SEED SPECIFICATION FOR SEED QUALITY

(5-17-11)

Z-3

Seed shall be sampled and tested by the North Carolina Department of Agriculture and Consumer Services, Seed Testing Laboratory. When said samples are collected, the vendor shall supply an independent laboratory report for each lot to be tested. Results from seed so sampled shall be final. Seed not meeting the specifications shall be rejected by the Department of Transportation and shall not be delivered to North Carolina Department of Transportation warehouses. If seed has been delivered it shall be available for pickup and replacement at the supplier's expense.

Any re-labeling required by the North Carolina Department of Agriculture and Consumer Services, Seed Testing Laboratory, that would cause the label to reflect as otherwise specified herein shall be rejected by the North Carolina Department of Transportation.

Seed shall be free from seeds of the noxious weeds Johnsongrass, Balloonvine, Jimsonweed, Witchweed, Itchgrass, Serrated Tussock, Showy Croton, Smooth Croton, Sicklepod, Sandbur, Wild Onion, and Wild Garlic. Seed shall not be labeled with the above weed species on the seed analysis label. Tolerances as applied by the Association of Official Seed Analysts will NOT be allowed for the above noxious weeds except for Wild Onion and Wild Garlic.

Tolerances established by the Association of Official Seed Analysts will generally be recognized. However, for the purpose of figuring pure live seed, the found pure seed and found germination percentages as reported by the North Carolina Department of Agriculture and Consumer Services, Seed Testing Laboratory will be used. Allowances, as established by the NCDOT, will be recognized for minimum pure live seed as listed on the following pages.

The specifications for restricted noxious weed seed refers to the number per pound as follows:

<u>Restricted Noxious Weed</u>	<u>Limitations per Lb. Of Seed</u>	<u>Restricted Noxious Weed</u>	<u>Limitations per Lb. of Seed</u>
Blessed Thistle	4 seeds	Cornflower (Ragged Robin)	27 seeds
Cocklebur	4 seeds	Texas Panicum	27 seeds
Spurred Anoda	4 seeds	Bracted Plantain	54 seeds
Velvetleaf	4 seeds	Buckhorn Plantain	54 seeds
Morning-glory	8 seeds	Broadleaf Dock	54 seeds
Corn Cockle	10 seeds	Curly Dock	54 seeds
Wild Radish	12 seeds	Dodder	54 seeds
Purple Nutsedge	27 seeds	Giant Foxtail	54 seeds
Yellow Nutsedge	27 seeds	Horsenettle	54 seeds
Canada Thistle	27 seeds	Quackgrass	54 seeds
Field Bindweed	27 seeds	Wild Mustard	54 seeds
Hedge Bindweed	27 seeds		

Seed of Pensacola Bahiagrass shall not contain more than 7% inert matter, Kentucky Bluegrass, Centipede and Fine or Hard Fescue shall not contain more than 5% inert matter whereas a

maximum of 2% inert matter will be allowed on all other kinds of seed. In addition, all seed shall not contain more than 2% other crop seed nor more than 1% total weed seed. The germination rate as tested by the North Carolina Department of Agriculture shall not fall below 70%, which includes both dormant and hard seed. Seed shall be labeled with not more than 7%, 5% or 2% inert matter (according to above specifications), 2% other crop seed and 1% total weed seed.

Exceptions may be made for minimum pure live seed allowances when cases of seed variety shortages are verified. Pure live seed percentages will be applied in a verified shortage situation. Those purchase orders of deficient seed lots will be credited with the percentage that the seed is deficient.

FURTHER SPECIFICATIONS FOR EACH SEED GROUP ARE GIVEN BELOW:

Minimum 85% pure live seed; maximum 1% total weed seed; maximum 2% total other crop seed; maximum 144 restricted noxious weed seed per pound. Seed less than 83% pure live seed will not be approved.

Sericea Lespedeza
Oats (seeds)

Minimum 80% pure live seed; maximum 1% total weed seed; maximum 2% total other crop; maximum 144 restricted noxious weed seed per pound. Seed less than 78% pure live seed will not be approved.

Tall Fescue (all approved varieties)	Bermudagrass
Kobe Lespedeza	Browntop Millet
Korean Lespedeza	German Millet – Strain R
Weeping Lovegrass	Clover – Red/White/Crimson
Carpetgrass	

Minimum 78% pure live seed; maximum 1% total weed seed; maximum 2% total other crop seed; maximum 144 restricted noxious weed seed per pound. Seed less than 76% pure live seed will not be approved.

Common or Sweet Sundangrass

Minimum 76% pure live seed; maximum 1% total weed seed; maximum 2% total other crop seed; maximum 144 restricted noxious weed seed per pound. Seed less than 74% pure live seed will not be approved.

Rye (grain; all varieties)
Kentucky Bluegrass (all approved varieties)
Hard Fescue (all approved varieties)
Shrub (bicolor) Lespedeza

Minimum 70% pure live seed; maximum 1% total weed seed; maximum 2% total other crop seed; maximum 144 noxious weed seed per pound. Seed less than 70% pure live seed will not be approved.

Centipedegrass	Japanese Millet
Crownvetch	Reed Canary Grass

Pensacola Bahiagrass
Creeping Red Fescue

Zoysia

Minimum 70% pure live seed; maximum 1% total weed seed; maximum 2% total other crop seed; maximum 5% inert matter; maximum 144 restricted noxious weed seed per pound.

Barnyard Grass
Big Bluestem
Little Bluestem
Bristly Locust
Birdsfoot Trefoil
Indiangrass
Orchardgrass
Switchgrass
Yellow Blossom Sweet Clover

STANDARD SPECIAL PROVISION
ERRATA

(1-16-24)

Z-4

Revise the *2024 Standard Specifications* as follows:

Division 3

Page 3-5, Article 305-2 MATERIALS, after line 16, replace " 1032-3(A)(7)" with "1032-3" and add the item "Galvanized Corrugated Steel Pipe" with Section "1032-3".

Page 3-6, Article 310-2 MATERIALS, after line 9, add the item "Galvanized Corrugated Steel Pipe" with Section "1032-3".

Division 9

Page 9-17, Article 904-4 MEASUREMENT AND PAYMENT, prior to line 1, replace " Sign Erection, Relocate Type (Ground Mounted)" with "Sign Erection, Relocate Type ___ (Ground Mounted)".

Division 10

Page 10-51, Article 1024-4 WATER, prior to line 1, delete the "unpopulated blank row" in Table 1024-2 between "Time of set, deviation from control" and "Chloride Ion Content, Max.".

Page 10-170, Subarticle 1081-1(C) Requirements, line 4, replace "maximum" with "minimum".

Division 11

Page 11-15, Article 1160-4 MEASUREMENT AND PAYMENT, line 24, replace "Where barrier units are moved more than one" with "Where barrier units are moved more than once".

Division 15

Page 15-10, Article 1515-4 MEASUREMENT AND PAYMENT, lines 11, replace " All piping" with "All labor, the manhole, other materials, excavation, backfilling, piping".

Division 16

Page 16-14, Article 1633-5 MEASUREMENT AND PAYMENT, line 20-24 and prior to line 25, delete and replace with the following " *Flocculant* will be measured and paid in accordance with Article 1642-5 applied to the temporary rock silt checks."

Page 16-3, Article 1609-2 MATERIALS, after line 26, replace "Type 4" with "Type 4a".

Page 16-25, Article 1644-2 MATERIALS, after line 22, replace "Type 4" with "Type 4a".

STANDARD SPECIAL PROVISION**PLANT AND PEST QUARANTINES****(Imported Fire Ant, Gypsy Moth, Witchweed, Emerald Ash Borer, Guava Root Knot Nematode, And Other Noxious Weeds)**

(3-18-03) (Rev. 5-21-19)

Z-04a

Within Quarantined Area

This project may be within a county regulated for plant and/or pests. If the project or any part of the Contractor's operations is located within a quarantined area, thoroughly clean all equipment prior to moving out of the quarantined area. Comply with federal/state regulations by obtaining a certificate or limited permit for any regulated article moving from the quarantined area.

Originating in a Quarantined County

Obtain a certificate or limited permit issued by the N.C. Department of Agriculture/United States Department of Agriculture. Have the certificate or limited permit accompany the article when it arrives at the project site.

Contact

Contact the N.C. Department of Agriculture/United States Department of Agriculture at 1-800-206-9333, 919-707-3730, or <https://www.ncagr.gov/plantindustry/Plant/quaran/table2.htm> to determine those specific project sites located in the quarantined area or for any regulated article used on this project originating in a quarantined county.

Regulated Articles Include

1. Soil, sand, gravel, compost, peat, humus, muck, and decomposed manure, separately or with other articles. This includes movement of articles listed above that may be associated with cut/waste, ditch pulling, and shoulder cutting.
2. Plants with roots including grass sod.
3. Plant crowns and roots.
4. Bulbs, corms, rhizomes, and tubers of ornamental plants.
5. Hay, straw, fodder, and plant litter of any kind.
6. Clearing and grubbing debris.
7. Used agricultural cultivating and harvesting equipment.
8. Used earth-moving equipment.
9. Any other products, articles, or means of conveyance, of any character, if determined by an inspector to present a hazard of spreading imported fire ant, gypsy moth, witchweed, emerald ash borer, guava root knot nematode, or other noxious weeds.

STANDARD SPECIAL PROVISION**TITLE VI AND NONDISCRIMINATION:**

(6-28-77)(Rev 1/16/2024)

Z-6

The North Carolina Department of Transportation is committed to carrying out the U.S. Department of Transportation's policy of ensuring nondiscrimination in the award and administration of contracts.

The provisions of this section related to United States Department of Transportation (US DOT) Order 1050.2A, Title 49 Code of Federal Regulations (CFR) part 21, 23 United States Code (U.S.C.) 140 and 23 CFR part 200 (or 49 CFR 303, 49 U.S.C. 5332 or 49 U.S.C. 47123) are applicable to all North Carolina Department of Transportation (NCDOT) contracts and to all related subcontracts, material supply, engineering, architectural and other service contracts, regardless of dollar amount. Any Federal provision that is specifically required not specifically set forth is hereby incorporated by reference.

(1) Title VI Assurances (USDOT Order 1050.2A, Appendix A)

During the performance of this contract, the contractor, for itself, its assignees, and successors in interest (hereinafter referred to as the "contractor") agrees as follows:

(a) Compliance with Regulations

The contractor (hereinafter includes consultants) shall comply with the Acts and the Regulations relative to Nondiscrimination in Federally-assisted programs of the U.S. Department of Transportation, Federal Highway Administration (FHWA), as they may be amended from time to time, which are herein incorporated by reference and made a part of this contract.

(b) Nondiscrimination

The contractor, with regard to the work performed by it during the contract, shall not discriminate on the grounds of race, color, or national origin in the selection and retention of subcontractors, including procurements of materials and leases of equipment. The contractor shall not participate directly or indirectly in the discrimination prohibited by the Acts and the Regulations, including employment practices when the contract covers any activity, project, or program set forth in Appendix B of 49 CFR Part 21.

(c) Solicitations for Subcontractors, Including Procurements of Materials and Equipment

In all solicitations, either by competitive bidding, or negotiation made by the contractor for work to be performed under a subcontract, including procurements of materials, or leases of equipment, each potential subcontractor or supplier shall be notified by the contractor of the contractor's obligations under this contract and the Acts and the Regulations relative to Nondiscrimination on the grounds of race, color, or national origin.

(d) Information and Reports

The contractor shall provide all information and reports required by the Acts, the Regulations, and directives issued pursuant thereto and shall permit access to its

books, records, accounts, other sources of information, and its facilities as may be determined by the Recipient or the FHWA to be pertinent to ascertain compliance with such Acts, Regulations, and instructions. Where any information required of a contractor is in the exclusive possession of another who fails or refuses to furnish the information, the contractor shall so certify to the Recipient or the FHWA, as appropriate, and shall set forth what efforts it has made to obtain the information.

(e) Sanctions for Noncompliance:

In the event of a contractor's noncompliance with the Non-discrimination provisions of this contract, the Recipient will impose such contract sanctions as it and/or the FHWA may determine to be appropriate, including, but not limited to:

- (i) Withholding payments to the contractor under the contract until the contractor complies; and/or
- (ii) Cancelling, terminating, or suspending a contract, in whole or in part.

(f) Incorporation of Provisions

The contractor shall include the provisions of paragraphs (a) through (f) in every subcontract, including procurements of materials and leases of equipment, unless exempt by the Acts, the Regulations and directives issued pursuant thereto. The contractor shall take action with respect to any subcontract or procurement as the Recipient or the FHWA may direct as a means of enforcing such provisions including sanctions for noncompliance. Provided, that if the contractor becomes involved in, or is threatened with litigation by a subcontractor, or supplier because of such direction, the contractor may request the Recipient to enter into any litigation to protect the interests of the Recipient. In addition, the contractor may request the United States to enter into the litigation to protect the interests of the United States.

(2) Title VI Nondiscrimination Program (23 CFR 200.5(p))

The North Carolina Department of Transportation (NCDOT) has assured the USDOT that, as a condition to receiving federal financial assistance, NCDOT will comply with Title VI of the Civil Rights Act of 1964 and all requirements imposed by Title 49 CFR part 21 and related nondiscrimination authorities to ensure that no person shall, on the ground of race, color, national origin, limited English proficiency, sex, age, or disability (including religion/creed or income-level, where applicable), be excluded from participation in, be denied the benefits of, or be subjected to discrimination under any programs, activities, or services conducted or funded by NCDOT. Contractors and other organizations under contract or agreement with NCDOT must also comply with Title VI and related authorities, therefore:

- (a) During the performance of this contract or agreement, contractors (e.g., subcontractors, consultants, vendors, prime contractors) are responsible for complying with NCDOT's Title VI Program. Contractors are not required to prepare or submit Title VI Programs. To comply with this section, the prime contractor shall:
 1. Post NCDOT's Notice of Nondiscrimination and the Contractor's own Equal Employment Opportunity (EEO) Policy in conspicuous locations accessible to all employees, applicants and subcontractors on the jobsite.

2. Physically incorporate the required Title VI clauses into all subcontracts on federally-assisted and state-funded NCDOT projects, and ensure inclusion by subcontractors into all lower-tier subcontracts.
 3. Required Solicitation Language. The Contractor shall include the following notification in all solicitations for bids and requests for work or material, regardless of funding source:

“The North Carolina Department of Transportation, in accordance with the provisions of Title VI of the Civil Rights Act of 1964 (78 Stat. 252, 42 U.S.C. §§ 2000d to 2000d-4) and the Regulations, hereby notifies all bidders that it will affirmatively ensure that any contract entered into pursuant to this advertisement, disadvantaged business enterprises will be afforded full and fair opportunity to submit bids in response to this invitation and will not be discriminated against on the grounds of race, color, or national origin in consideration for an award. In accordance with other related nondiscrimination authorities, bidders and contractors will also not be discriminated against on the grounds of sex, age, disability, low-income level, creed/religion, or limited English proficiency in consideration for an award.”
 4. Physically incorporate the FHWA-1273, in its entirety, into all subcontracts and subsequent lower tier subcontracts on Federal-aid highway construction contracts only.
 5. Provide language assistance services (i.e., written translation and oral interpretation), free of charge, to LEP employees and applicants. Contact NCDOT OCR for further assistance, if needed.
 6. For assistance with these Title VI requirements, contact the NCDOT Title VI Nondiscrimination Program at 1-800-522-0453.
- (b) Subrecipients (e.g. cities, counties, LGAs, planning organizations) may be required to prepare and submit a Title VI Plan to NCDOT, including Title VI Assurances and/or agreements. Subrecipients must also ensure compliance by their contractors and subrecipients with Title VI. (23 CFR 200.9(b)(7))
- (c) If reviewed or investigated by NCDOT, the contractor or subrecipient agrees to take affirmative action to correct any deficiencies found within a reasonable time period, not to exceed 90 calendar days, unless additional time is granted by NCDOT. (23 CFR 200.9(b)(15))
- (d) The Contractor is responsible for notifying subcontractors of NCDOT’s External Discrimination Complaints Process.
1. Applicability

Title VI and related laws protect participants and beneficiaries (e.g., members of the public and contractors) from discrimination by NCDOT employees, subrecipients and contractors, regardless of funding source.

2. Eligibility

Any person—or class of persons—who believes he/she has been subjected to discrimination based on race, color, national origin, Limited English Proficiency (LEP), sex, age, or disability (and religion in the context of employment, aviation, or transit) may file a written complaint. The law also prohibits intimidation or retaliation of any sort.

3. Time Limits and Filing Options

Complaints may be filed by the affected individual(s) or a representative and must be filed no later than 180 calendar days after the following:

- (i) The date of the alleged act of discrimination; or
- (ii) The date when the person(s) became aware of the alleged discrimination; or
- (iii) Where there has been a continuing course of conduct, the date on which that conduct was discontinued or the latest instance of the conduct.

Title VI and related discrimination complaints may be submitted to the following entities:

- North Carolina Department of Transportation, Office of Civil Rights, Title VI Program, 1511 Mail Service Center, Raleigh, NC 27699-1511; toll free 1-800-522-0453
- Federal Highway Administration, North Carolina Division Office, 310 New Bern Avenue, Suite 410, Raleigh, NC 27601, 919-747-7010
- US Department of Transportation, Departmental Office of Civil Rights, External Civil Rights Programs Division, 1200 New Jersey Avenue, SE, Washington, DC 20590; 202-366-4070

4. Format for Complaints

Complaints must be in writing and signed by the complainant(s) or a representative, and include the complainant's name, address, and telephone number. Complaints received by fax or e-mail will be acknowledged and processed. Allegations received by telephone will be reduced to writing and provided to the complainant for confirmation or revision before processing. Complaints will be accepted in other languages, including Braille.

5. Discrimination Complaint Form

Contact NCDOT Civil Rights to receive a full copy of the Discrimination Complaint Form and procedures.

6. Complaint Basis

Allegations must be based on issues involving race, color, national origin (LEP), sex, age, disability, or religion (in the context of employment, aviation or transit). "Basis" refers to the complainant's membership in a protected group category.

**TABLE 103-1
COMPLAINT BASIS**

Protected Categories	Definition	Examples	Applicable Nondiscrimination Authorities
Race and Ethnicity	An individual belonging to one of the accepted racial groups; or the perception, based usually on physical characteristics that a person is a member of a racial group	Black/African American, Hispanic/Latino, Asian, American Indian/Alaska Native, Native Hawaiian/Pacific Islander, White	Title VI of the Civil Rights Act of 1964; 49 CFR Part 21; 23 CFR 200; 49 U.S.C. 5332(b); 49 U.S.C. 47123. (<i>Executive Order 13166</i>)
Color	Color of skin, including shade of skin within a racial group	Black, White, brown, yellow, etc.	
National Origin (<i>Limited English Proficiency</i>)	Place of birth. Citizenship is not a factor. (<i>Discrimination based on language or a person's accent is also covered</i>)	Mexican, Cuban, Japanese, Vietnamese, Chinese	
Sex	Gender. The sex of an individual. <i>Note: Sex under this program does not include sexual orientation.</i>	Women and Men	1973 Federal-Aid Highway Act; 49 U.S.C. 5332(b); 49 U.S.C. 47123.
Age	Persons of any age	21-year-old person	Age Discrimination Act of 1975 49 U.S.C. 5332(b); 49 U.S.C. 47123.
Disability	Physical or mental impairment, permanent or temporary, or perceived.	Blind, alcoholic, para-amputee, epileptic, diabetic, arthritic	Section 504 of the Rehabilitation Act of 1973; Americans with Disabilities Act of 1990
Religion (in the context of employment) (<i>Religion/ Creed in all aspects of any aviation or transit-related construction</i>)	An individual belonging to a religious group; or the perception, based on distinguishable characteristics that a person is a member of a religious group. In practice, actions taken as a result of the moral and ethical beliefs as to what is right and wrong, which are sincerely held with the strength of traditional religious views. <i>Note: Does not have to be associated with a recognized religious group or church; if an individual sincerely holds to the belief, it is a protected religious practice.</i>	Muslim, Christian, Sikh, Hindu, etc.	Title VII of the Civil Rights Act of 1964; 23 CFR 230; FHWA-1273 Required Contract Provisions. (<i>49 U.S.C. 5332(b); 49 U.S.C. 47123</i>)

(3) Pertinent Nondiscrimination Authorities

During the performance of this contract, the contractor, for itself, its assignees, and successors in interest agrees to comply with the following non-discrimination statutes and authorities, including, but not limited to:

- (a) Title VI of the Civil Rights Act of 1964 (42 U.S.C. § 2000d et seq., 78 stat. 252), (prohibits discrimination on the basis of race, color, national origin); and 49 CFR Part 21.

- (b) The Uniform Relocation Assistance and Real Property Acquisition Policies Act of 1970, (42 U.S.C. § 4601), (prohibits unfair treatment of persons displaced or whose property has been acquired because of Federal or Federal-aid programs and projects);
- (c) Federal-Aid Highway Act of 1973, (23 U.S.C. § 324 et seq.), (prohibits discrimination on the basis of sex);
- (d) Section 504 of the Rehabilitation Act of 1973, (29 U.S.C. § 794 et seq.), as amended, (prohibits discrimination on the basis of disability) and 49 CFR Part 27;
- (e) The Age Discrimination Act of 1975, as amended, (42 U.S.C. § 6101 et seq.), (prohibits discrimination on the basis of age);
- (f) Airport and Airway Improvement Act of 1982, (49 USC § 471, Section 47123), as amended, (prohibits discrimination based on race, creed, color, national origin, or sex);
- (g) The Civil Rights Restoration Act of 1987, (PL 100-209), (Broadened the scope, coverage and applicability of Title VI of the Civil Rights Act of 1964, The Age Discrimination Act of 1975 and Section 504 of the Rehabilitation Act of 1973, by expanding the definition of the terms "programs or activities" to include all of the programs or activities of the Federal-aid recipients, sub-recipients and contractors, whether such programs or activities are Federally funded or not);
- (h) Titles II and III of the Americans with Disabilities Act, which prohibit discrimination on the basis of disability in the operation of public entities, public and private transportation systems, places of public accommodation, and certain testing entities (42 U.S.C. §§ 12131-12189) as implemented by Department of Transportation regulations at 49 C.F.R. parts 37 and 38;
- (i) The Federal Aviation Administration's Nondiscrimination statute (49 U.S.C. § 47123) (prohibits discrimination on the basis of race, color, national origin, and sex);
- (j) Executive Order 12898, Federal Actions to Address Environmental Justice in Minority Populations and Low-Income Populations, which ensures Nondiscrimination against minority populations by discouraging programs, policies, and activities with disproportionately high and adverse human health or environmental effects on minority and low-income populations;
- (k) Executive Order 13166, Improving Access to Services for Persons with Limited English Proficiency, and resulting agency guidance, national origin discrimination includes discrimination because of Limited English proficiency (LEP). To ensure compliance with Title VI, you must take reasonable steps to ensure that LEP persons have meaningful access to your programs (70 Fed. Reg. at 74087 to 74100);
- (l) Title IX of the Education Amendments of 1972, as amended, which prohibits you from discriminating because of sex in education programs or activities (20 U.S.C. 1681 et seq).
- (m) Title VII of the Civil Rights Act of 1964 (42 U.S.C. § 2000e et seq., Pub. L. 88-352), (prohibits employment discrimination on the basis of race, color, religion, sex, or national origin).

(4) **Additional Title VI Assurances**

***The following Title VI Assurances (Appendices B, C and D) shall apply, as applicable*

- (a) Clauses for Deeds Transferring United States Property (1050.2A, Appendix B)

The following clauses will be included in deeds effecting or recording the transfer of real property, structures, or improvements thereon, or granting interest therein from the United States pursuant to the provisions of Assurance 4.

NOW, THEREFORE, the U.S. Department of Transportation as authorized by law and upon the condition that the North Carolina Department of Transportation (NCDOT) will accept title to the lands and maintain the project constructed thereon in accordance with the North Carolina General Assembly, the Regulations for the Administration of the Federal-Aid Highway Program, and the policies and procedures prescribed by the Federal Highway Administration of the U.S. Department of Transportation in accordance and in compliance with all requirements imposed by Title 49, Code of Federal Regulations, U.S. Department of Transportation, Subtitle A, Office of the Secretary, Part 21, Nondiscrimination in Federally-assisted programs of the U.S. Department of Transportation pertaining to and effectuating the provisions of Title VI of the Civil Rights Act of 1964 (78 Stat. 252; 42 U.S.C. § 2000d to 2000d-4), does hereby remise, release, quitclaim and convey unto the NCDOT all the right, title and interest of the U.S. Department of Transportation in and to said lands described in Exhibit A attached hereto and made a part hereof.

(HABENDUM CLAUSE)

TO HAVE AND TO HOLD said lands and interests therein unto the North Carolina Department of Transportation (NCDOT) and its successors forever, subject, however, to the covenants, conditions, restrictions and reservations herein contained as follows, which will remain in effect for the period during which the real property or structures are used for a purpose for which Federal financial assistance is extended or for another purpose involving the provision of similar services or benefits and will be binding on the NCDOT, its successors and assigns.

The NCDOT, in consideration of the conveyance of said lands and interests in lands, does hereby covenant and agree as a covenant running with the land for itself, its successors and assigns, that (1) no person will on the grounds of race, color, or national origin, be excluded from participation in, be denied the benefits of, or be otherwise subjected to discrimination with regard to any facility located wholly or in part on, over, or under such lands hereby conveyed [,] [and]* (2) that the NCDOT will use the lands and interests in lands and interests in lands so conveyed, in compliance with all requirements imposed by or pursuant to Title 49, Code of Federal Regulations, U.S. Department of Transportation, Subtitle A, Office of the Secretary, Part 21, Non-discrimination in Federally-assisted programs of the U.S. Department of Transportation, Effectuation of Title VI of the Civil Rights Act of 1964, and as said Regulations and Acts may be amended [, and (3) that in the event of breach of any of the above-mentioned nondiscrimination conditions, the Department will have a right to enter or re-enter said lands and facilities on said land, and that above described land and facilities will thereon revert to and vest in and become the absolute property of the U.S. Department of Transportation and its assigns as such interest existed prior to this instruction].*

(*Reverter clause and related language to be used only when it is determined that such a clause is necessary in order to make clear the purpose of Title VI.)

(b) Clauses for Transfer of Real Property Acquired or Improved Under the Activity, Facility, or Program (1050.2A, Appendix C)

The following clauses will be included in deeds, licenses, leases, permits, or similar instruments entered into by the North Carolina Department of Transportation (NCDOT) pursuant to the provisions of Assurance 7(a):

1. The (grantee, lessee, permittee, etc. as appropriate) for himself/herself, his/her heirs, personal representatives, successors in interest, and assigns, as a part of the consideration hereof, does hereby covenant and agree [in the case of deeds and leases add "as a covenant running with the land"] that:
 - (i.) In the event facilities are constructed, maintained, or otherwise operated on the property described in this (deed, license, lease, permit, etc.) for a purpose for which a U.S. Department of Transportation activity, facility, or program is extended or for another purpose involving the provision of similar services or benefits, the (grantee, licensee, lessee, permittee, etc.) will maintain and operate such facilities and services in compliance with all requirements imposed by the Acts and Regulations (as may be amended) such that no person on the grounds of race, color, or national origin, will be excluded from participation in, denied the benefits of, or be otherwise subjected to discrimination in the use of said facilities.
2. With respect to licenses, leases, permits, etc., in the event of breach of any of the above Nondiscrimination covenants, the NCDOT will have the right to terminate the (lease, license, permit, etc.) and to enter, re-enter, and repossess said lands and facilities thereon, and hold the same as if the (lease, license, permit, etc.) had never been made or issued. *
3. With respect to a deed, in the event of breach of any of the above Nondiscrimination covenants, the NCDOT will have the right to enter or re-enter the lands and facilities thereon, and the above described lands and facilities will there upon revert to and vest in and become the absolute property of the NCDOT and its assigns. *

(*Reverter clause and related language to be used only when it is determined that such a clause is necessary to make clear the purpose of Title VI.)

(c) Clauses for Construction/Use/Access to Real Property Acquired Under the Activity, Facility or Program (1050.2A, Appendix D)

The following clauses will be included in deeds, licenses, permits, or similar instruments/ agreements entered into by the North Carolina Department of Transportation (NCDOT) pursuant to the provisions of Assurance 7(b):

1. The (grantee, licensee, permittee, etc., as appropriate) for himself/herself, his/her heirs, personal representatives, successors in interest, and assigns, as a part of the consideration hereof, does hereby covenant and agree (in the case of deeds and leases add, "as a covenant running with the land") that (1) no person on the ground of race, color, or national origin, will be excluded from participation in, denied the benefits of, or be otherwise subjected to discrimination in the use of said facilities, (2) that in the construction of any improvements on, over, or under such land, and the furnishing of services thereon, no person on the ground of race, color, or national origin, will be excluded from participation in, denied the benefits of, or otherwise be subjected to discrimination, (3) that the (grantee, licensee, lessee, permittee, etc.) will use the premises in compliance with all other requirements imposed by or pursuant to the Acts and Regulations, as amended, set forth in this Assurance.
2. With respect to (licenses, leases, permits, etc.), in the event of breach of any of the above Non- discrimination covenants, the NCDOT will have the right to terminate the (license, permit, etc., as appropriate) and to enter or re-enter and repossess said land and the facilities thereon, and hold the same as if said (license, permit, etc., as appropriate) had never been made or issued. *
3. With respect to deeds, in the event of breach of any of the above Nondiscrimination covenants, the NCDOT will there upon revert to and vest in and become the absolute property of the NCDOT and its assigns. *

(*Reverter clause and related language to be used only when it is determined that such a clause is necessary to make clear the purpose of Title VI.)

STANDARD SPECIAL PROVISION**MINORITY AND FEMALE EMPLOYMENT REQUIREMENTS**

Z-7

NOTICE OF REQUIREMENTS FOR AFFIRMATIVE ACTION TO ENSURE EQUAL EMPLOYMENT OPPORTUNITY (*EXECUTIVE NUMBER 11246*)

1. The goals and timetables for minority and female participation, expressed in percentage terms for the Contractor's aggregate workforce in each trade on all construction work in the covered area, see as shown on the attached sheet entitled "Employment Goals for Minority and Female participation".

These goals are applicable to all the Contractor's construction work (whether or not it is Federal or federally assisted) performed in the covered area. If the Contractor performs construction work in a geographical area located outside of the covered area, it shall apply the goals established for such geographical area where the work is actually performed. With regard to this second area, the Contractor also is subject to the goals for both its federally involved and nonfederally involved construction.

The Contractor's compliance with the Executive Order and the regulations in *41 CFR Part 60-4* shall be based on its implementation of the Equal Opportunity Clause, specific affirmative action obligations required by the specifications set forth in *41 CFR 60-4.3(a)*, and its effort to meet the goals. The hours of minority and female employment and training must be substantially uniform throughout the length of the contract, and in each trade and the Contractor shall make a good faith effort to employ minorities and women evenly on each of its projects. The transfer of minority or female employees or trainees from Contractor to Contractor or from project to project for the sole purpose of meeting the Contractor's goals shall be a violation of the contract, the executive Order and the regulations in *41 CFR Part 60-4*. Compliance with the goals will be measured against the total work hours performed.

2. As used in this Notice and in the contract resulting from this solicitation, the "covered area" is the county or counties shown on the cover sheet of the proposal form and contract.

**EMPLOYMENT GOALS FOR MINORITY
AND FEMALE PARTICIPATION**

Economic Areas

Area 023 29.7%

Bertie County
Camden County
Chowan County
Gates County
Hertford County
Pasquotank County
Perquimans County

Area 024 31.7%

Beaufort County
Carteret County
Craven County
Dare County
Edgecombe County
Green County
Halifax County
Hyde County
Jones County
Lenoir County
Martin County
Nash County
Northampton County
Pamlico County
Pitt County
Tyrrell County
Washington County
Wayne County
Wilson County

Area 025 23.5%

Columbus County
Duplin County
Onslow County
Pender County

Area 026 33.5%

Bladen County
Hoke County
Richmond County
Robeson County
Sampson County
Scotland County

Area 027 24.7%

Chatham County
Franklin County
Granville County
Harnett County
Johnston County
Lee County
Person County
Vance County
Warren County

Area 028 15.5%

Alleghany County
Ashe County
Caswell County
Davie County
Montgomery County
Moore County
Rockingham County
Surry County
Watauga County
Wilkes County

Area 029 15.7%

Alexander County
Anson County
Burke County
Cabarrus County
Caldwell County
Catawba County
Cleveland County
Iredell County
Lincoln County
Polk County
Rowan County
Rutherford County
Stanly County

Area 0480 8.5%

Buncombe County
Madison County

Area 030 6.3%

Avery County
Cherokee County
Clay County
Graham County
Haywood County
Henderson County
Jackson County
McDowell County
Macon County
Mitchell County
Swain County
Transylvania County
Yancey County

SMSA Areas

Area 5720 26.6%

Currituck County

Area 9200 20.7%

Brunswick County

New Hanover County

Area 2560 24.2%

Cumberland County

Area 6640 22.8%

Durham County

Orange County

Wake County

Area 1300 16.2%

Alamance County

Area 3120 16.4%

Davidson County

Forsyth County

Guilford County

Randolph County

Stokes County

Yadkin County

Area 1520 18.3%

Gaston County

Mecklenburg County

Union County

Goals for Female

Participation in Each Trade

(Statewide) 6.9%

FHWA-1273 -- Revised October 23, 2023

REQUIRED CONTRACT PROVISIONS FEDERAL-AID CONSTRUCTION CONTRACTS

- I. General
- II. Nondiscrimination
- III. Non-segregated Facilities
- IV. Davis-Bacon and Related Act Provisions
- V. Contract Work Hours and Safety Standards Act Provisions
- VI. Subletting or Assigning the Contract
- VII. Safety: Accident Prevention
- VIII. False Statements Concerning Highway Projects
- IX. Implementation of Clean Air Act and Federal Water Pollution Control Act
- X. Certification Regarding Debarment, Suspension, Ineligibility and Voluntary Exclusion
- XI. Certification Regarding Use of Contract Funds for Lobbying
- XII. Use of United States-Flag Vessels:

ATTACHMENTS

A. Employment and Materials Preference for Appalachian Development Highway System or Appalachian Local Access Road Contracts (included in Appalachian contracts only)

I. GENERAL

1. Form FHWA-1273 must be physically incorporated in each construction contract funded under title 23, United States Code, as required in 23 CFR 633.102(b) (excluding emergency contracts solely intended for debris removal). The contractor (or subcontractor) must insert this form in each subcontract and further require its inclusion in all lower tier subcontracts (excluding purchase orders, rental agreements and other agreements for supplies or services). 23 CFR 633.102(e).

The applicable requirements of Form FHWA-1273 are incorporated by reference for work done under any purchase order, rental agreement or agreement for other services. The prime contractor shall be responsible for compliance by any subcontractor, lower-tier subcontractor or service provider. 23 CFR 633.102(e).

Form FHWA-1273 must be included in all Federal-aid design-build contracts, in all subcontracts and in lower tier subcontracts (excluding subcontracts for design services, purchase orders, rental agreements and other agreements for supplies or services) in accordance with 23 CFR 633.102. The design-builder shall be responsible for compliance by any subcontractor, lower-tier subcontractor or service provider.

Contracting agencies may reference Form FHWA-1273 in solicitation-for-bids or request-for-proposals documents, however, the Form FHWA-1273 must be physically incorporated (not referenced) in all contracts, subcontracts and lower-tier subcontracts (excluding purchase orders, rental agreements and other agreements for supplies or services related to a construction contract). 23 CFR 633.102(b).

2. Subject to the applicability criteria noted in the following sections, these contract provisions shall apply to all work

performed on the contract by the contractor's own organization and with the assistance of workers under the contractor's immediate superintendence and to all work performed on the contract by piecework, station work, or by subcontract. 23 CFR 633.102(d).

3. A breach of any of the stipulations contained in these Required Contract Provisions may be sufficient grounds for withholding of progress payments, withholding of final payment, termination of the contract, suspension / debarment or any other action determined to be appropriate by the contracting agency and FHWA.

4. Selection of Labor: During the performance of this contract, the contractor shall not use convict labor for any purpose within the limits of a construction project on a Federal-aid highway unless it is labor performed by convicts who are on parole, supervised release, or probation. 23 U.S.C. 114(b). The term Federal-aid highway does not include roadways functionally classified as local roads or rural minor collectors. 23 U.S.C. 101(a).

II. NONDISCRIMINATION (23 CFR 230.107(a); 23 CFR Part 230, Subpart A, Appendix A; EO 11246)

The provisions of this section related to 23 CFR Part 230, Subpart A, Appendix A are applicable to all Federal-aid construction contracts and to all related construction subcontracts of \$10,000 or more. The provisions of 23 CFR Part 230 are not applicable to material supply, engineering, or architectural service contracts.

In addition, the contractor and all subcontractors must comply with the following policies: Executive Order 11246, 41 CFR Part 60, 29 CFR Parts 1625-1627, 23 U.S.C. 140, Section 504 of the Rehabilitation Act of 1973, as amended (29 U.S.C. 794), Title VI of the Civil Rights Act of 1964, as amended (42 U.S.C. 2000d et seq.), and related regulations including 49 CFR Parts 21, 26, and 27; and 23 CFR Parts 200, 230, and 633.

The contractor and all subcontractors must comply with: the requirements of the Equal Opportunity Clause in 41 CFR 60-1.4(b) and, for all construction contracts exceeding \$10,000, the Standard Federal Equal Employment Opportunity Construction Contract Specifications in 41 CFR 60-4.3.

Note: The U.S. Department of Labor has exclusive authority to determine compliance with Executive Order 11246 and the policies of the Secretary of Labor including 41 CFR Part 60, and 29 CFR Parts 1625-1627. The contracting agency and the FHWA have the authority and the responsibility to ensure compliance with 23 U.S.C. 140, Section 504 of the Rehabilitation Act of 1973, as amended (29 U.S.C. 794), and Title VI of the Civil Rights Act of 1964, as amended (42 U.S.C. 2000d et seq.), and related regulations including 49 CFR Parts 21, 26, and 27; and 23 CFR Parts 200, 230, and 633.

The following provision is adopted from 23 CFR Part 230, Subpart A, Appendix A, with appropriate revisions to conform to the U.S. Department of Labor (US DOL) and FHWA requirements.

1. Equal Employment Opportunity: Equal Employment Opportunity (EEO) requirements not to discriminate and to take affirmative action to assure equal opportunity as set forth under laws, executive orders, rules, regulations (see 28 CFR Part 35, 29 CFR Part 1630, 29 CFR Parts 1625-1627, 41 CFR Part 60 and 49 CFR Part 27) and orders of the Secretary of Labor as modified by the provisions prescribed herein, and imposed pursuant to 23 U.S.C. 140, shall constitute the EEO and specific affirmative action standards for the contractor's project activities under this contract. The provisions of the Americans with Disabilities Act of 1990 (42 U.S.C. 12101 et seq.) set forth under 28 CFR Part 35 and 29 CFR Part 1630 are incorporated by reference in this contract. In the execution of this contract, the contractor agrees to comply with the following minimum specific requirement activities of EEO:

a. The contractor will work with the contracting agency and the Federal Government to ensure that it has made every good faith effort to provide equal opportunity with respect to all of its terms and conditions of employment and in their review of activities under the contract. 23 CFR 230.409 (g)(4) & (5).

b. The contractor will accept as its operating policy the following statement:

"It is the policy of this Company to assure that applicants are employed, and that employees are treated during employment, without regard to their race, religion, sex, sexual orientation, gender identity, color, national origin, age or disability. Such action shall include: employment, upgrading, demotion, or transfer; recruitment or recruitment advertising; layoff or termination; rates of pay or other forms of compensation; and selection for training, including apprenticeship, pre-apprenticeship, and/or on-the-job training."

2. EEO Officer: The contractor will designate and make known to the contracting officers an EEO Officer who will have the responsibility for and must be capable of effectively administering and promoting an active EEO program and who must be assigned adequate authority and responsibility to do so.

3. Dissemination of Policy: All members of the contractor's staff who are authorized to hire, supervise, promote, and discharge employees, or who recommend such action or are substantially involved in such action, will be made fully cognizant of and will implement the contractor's EEO policy and contractual responsibilities to provide EEO in each grade and classification of employment. To ensure that the above agreement will be met, the following actions will be taken as a minimum:

a. Periodic meetings of supervisory and personnel office employees will be conducted before the start of work and then not less often than once every six months, at which time the contractor's EEO policy and its implementation will be reviewed and explained. The meetings will be conducted by the EEO Officer or other knowledgeable company official.

b. All new supervisory or personnel office employees will be given a thorough indoctrination by the EEO Officer, covering all major aspects of the contractor's EEO obligations within thirty days following their reporting for duty with the contractor.

c. All personnel who are engaged in direct recruitment for the project will be instructed by the EEO Officer in the contractor's procedures for locating and hiring minorities and women.

d. Notices and posters setting forth the contractor's EEO policy will be placed in areas readily accessible to employees, applicants for employment and potential employees.

e. The contractor's EEO policy and the procedures to implement such policy will be brought to the attention of employees by means of meetings, employee handbooks, or other appropriate means.

4. Recruitment: When advertising for employees, the contractor will include in all advertisements for employees the notation: "An Equal Opportunity Employer." All such advertisements will be placed in publications having a large circulation among minorities and women in the area from which the project work force would normally be derived.

a. The contractor will, unless precluded by a valid bargaining agreement, conduct systematic and direct recruitment through public and private employee referral sources likely to yield qualified minorities and women. To meet this requirement, the contractor will identify sources of potential minority group employees and establish with such identified sources procedures whereby minority and women applicants may be referred to the contractor for employment consideration.

b. In the event the contractor has a valid bargaining agreement providing for exclusive hiring hall referrals, the contractor is expected to observe the provisions of that agreement to the extent that the system meets the contractor's compliance with EEO contract provisions. Where implementation of such an agreement has the effect of discriminating against minorities or women, or obligates the contractor to do the same, such implementation violates Federal nondiscrimination provisions.

c. The contractor will encourage its present employees to refer minorities and women as applicants for employment. Information and procedures with regard to referring such applicants will be discussed with employees.

5. Personnel Actions: Wages, working conditions, and employee benefits shall be established and administered, and personnel actions of every type, including hiring, upgrading, promotion, transfer, demotion, layoff, and termination, shall be taken without regard to race, color, religion, sex, sexual orientation, gender identity, national origin, age or disability. The following procedures shall be followed:

a. The contractor will conduct periodic inspections of project sites to ensure that working conditions and employee facilities do not indicate discriminatory treatment of project site personnel.

b. The contractor will periodically evaluate the spread of wages paid within each classification to determine any evidence of discriminatory wage practices.

c. The contractor will periodically review selected personnel actions in depth to determine whether there is evidence of discrimination. Where evidence is found, the contractor will promptly take corrective action. If the review indicates that the discrimination may extend beyond the actions reviewed, such corrective action shall include all affected persons.

d. The contractor will promptly investigate all complaints of alleged discrimination made to the contractor in connection with its obligations under this contract, will attempt to resolve such complaints, and will take appropriate corrective action

within a reasonable time. If the investigation indicates that the discrimination may affect persons other than the complainant, such corrective action shall include such other persons. Upon completion of each investigation, the contractor will inform every complainant of all of their avenues of appeal.

6. Training and Promotion:

a. The contractor will assist in locating, qualifying, and increasing the skills of minorities and women who are applicants for employment or current employees. Such efforts should be aimed at developing full journey level status employees in the type of trade or job classification involved.

b. Consistent with the contractor's work force requirements and as permissible under Federal and State regulations, the contractor shall make full use of training programs (i.e., apprenticeship and on-the-job training programs for the geographical area of contract performance). In the event a special provision for training is provided under this contract, this subparagraph will be superseded as indicated in the special provision. The contracting agency may reserve training positions for persons who receive welfare assistance in accordance with 23 U.S.C. 140(a).

c. The contractor will advise employees and applicants for employment of available training programs and entrance requirements for each.

d. The contractor will periodically review the training and promotion potential of employees who are minorities and women and will encourage eligible employees to apply for such training and promotion.

7. Unions: If the contractor relies in whole or in part upon unions as a source of employees, the contractor will use good faith efforts to obtain the cooperation of such unions to increase opportunities for minorities and women. 23 CFR 230.409. Actions by the contractor, either directly or through a contractor's association acting as agent, will include the procedures set forth below:

a. The contractor will use good faith efforts to develop, in cooperation with the unions, joint training programs aimed toward qualifying more minorities and women for membership in the unions and increasing the skills of minorities and women so that they may qualify for higher paying employment.

b. The contractor will use good faith efforts to incorporate an EEO clause into each union agreement to the end that such union will be contractually bound to refer applicants without regard to their race, color, religion, sex, sexual orientation, gender identity, national origin, age, or disability.

c. The contractor is to obtain information as to the referral practices and policies of the labor union except that to the extent such information is within the exclusive possession of the labor union and such labor union refuses to furnish such information to the contractor, the contractor shall so certify to the contracting agency and shall set forth what efforts have been made to obtain such information.

d. In the event the union is unable to provide the contractor with a reasonable flow of referrals within the time limit set forth in the collective bargaining agreement, the contractor will, through independent recruitment efforts, fill the employment vacancies without regard to race, color, religion, sex, sexual orientation, gender identity, national origin, age, or disability; making full efforts to obtain qualified and/or qualifiable minorities and women. The failure of a union to provide

sufficient referrals (even though it is obligated to provide exclusive referrals under the terms of a collective bargaining agreement) does not relieve the contractor from the requirements of this paragraph. In the event the union referral practice prevents the contractor from meeting the obligations pursuant to Executive Order 11246, as amended, and these special provisions, such contractor shall immediately notify the contracting agency.

8. Reasonable Accommodation for Applicants / Employees with Disabilities: The contractor must be familiar with the requirements for and comply with the Americans with Disabilities Act and all rules and regulations established thereunder. Employers must provide reasonable accommodation in all employment activities unless to do so would cause an undue hardship.

9. Selection of Subcontractors, Procurement of Materials and Leasing of Equipment: The contractor shall not discriminate on the grounds of race, color, religion, sex, sexual orientation, gender identity, national origin, age, or disability in the selection and retention of subcontractors, including procurement of materials and leases of equipment. The contractor shall take all necessary and reasonable steps to ensure nondiscrimination in the administration of this contract.

a. The contractor shall notify all potential subcontractors, suppliers, and lessors of their EEO obligations under this contract.

b. The contractor will use good faith efforts to ensure subcontractor compliance with their EEO obligations.

10. Assurances Required:

a. The requirements of 49 CFR Part 26 and the State DOT's FHWA-approved Disadvantaged Business Enterprise (DBE) program are incorporated by reference.

b. The contractor, subrecipient or subcontractor shall not discriminate on the basis of race, color, national origin, or sex in the performance of this contract. The contractor shall carry out applicable requirements of 49 CFR part 26 in the award and administration of DOT-assisted contracts. Failure by the contractor to carry out these requirements is a material breach of this contract, which may result in the termination of this contract or such other remedy as the recipient deems appropriate, which may include, but is not limited to:

- (1) Withholding monthly progress payments;
- (2) Assessing sanctions;
- (3) Liquidated damages; and/or
- (4) Disqualifying the contractor from future bidding as non-responsible.

c. The Title VI and nondiscrimination provisions of U.S. DOT Order 1050.2A at Appendixes A and E are incorporated by reference. 49 CFR Part 21.

11. Records and Reports: The contractor shall keep such records as necessary to document compliance with the EEO requirements. Such records shall be retained for a period of three years following the date of the final payment to the contractor for all contract work and shall be available at reasonable times and places for inspection by authorized representatives of the contracting agency and the FHWA.

a. The records kept by the contractor shall document the following:

(1) The number and work hours of minority and non-minority group members and women employed in each work classification on the project;

(2) The progress and efforts being made in cooperation with unions, when applicable, to increase employment opportunities for minorities and women; and

(3) The progress and efforts being made in locating, hiring, training, qualifying, and upgrading minorities and women.

b. The contractors and subcontractors will submit an annual report to the contracting agency each July for the duration of the project indicating the number of minority, women, and non-minority group employees currently engaged in each work classification required by the contract work. This information is to be reported on [Form FHWA-1391](#). The staffing data should represent the project work force on board in all or any part of the last payroll period preceding the end of July. If on-the-job training is being required by special provision, the contractor will be required to collect and report training data. The employment data should reflect the work force on board during all or any part of the last payroll period preceding the end of July.

III. NONSEGREGATED FACILITIES

This provision is applicable to all Federal-aid construction contracts and to all related construction subcontracts of more than \$10,000. 41 CFR 60-1.5.

As prescribed by 41 CFR 60-1.8, the contractor must ensure that facilities provided for employees are provided in such a manner that segregation on the basis of race, color, religion, sex, sexual orientation, gender identity, or national origin cannot result. The contractor may neither require such segregated use by written or oral policies nor tolerate such use by employee custom. The contractor's obligation extends further to ensure that its employees are not assigned to perform their services at any location under the contractor's control where the facilities are segregated. The term "facilities" includes waiting rooms, work areas, restaurants and other eating areas, time clocks, restrooms, washrooms, locker rooms and other storage or dressing areas, parking lots, drinking fountains, recreation or entertainment areas, transportation, and housing provided for employees. The contractor shall provide separate or single-user restrooms and necessary dressing or sleeping areas to assure privacy between sexes.

IV. DAVIS-BACON AND RELATED ACT PROVISIONS

This section is applicable to all Federal-aid construction projects exceeding \$2,000 and to all related subcontracts and lower-tier subcontracts (regardless of subcontract size), in accordance with 29 CFR 5.5. The requirements apply to all projects located within the right-of-way of a roadway that is functionally classified as Federal-aid highway. 23 U.S.C. 113. This excludes roadways functionally classified as local roads or rural minor collectors, which are exempt. 23 U.S.C. 101. Where applicable law requires that projects be treated as a project on a Federal-aid highway, the provisions of this subpart will apply regardless of the location of the project. Examples include: Surface Transportation Block Grant Program projects funded under 23 U.S.C. 133 [excluding recreational trails projects], the Nationally Significant Freight and Highway

Projects funded under 23 U.S.C. 117, and National Highway Freight Program projects funded under 23 U.S.C. 167.

The following provisions are from the U.S. Department of Labor regulations in 29 CFR 5.5 "Contract provisions and related matters" with minor revisions to conform to the FHWA-1273 format and FHWA program requirements.

1. Minimum wages (29 CFR 5.5)

a. *Wage rates and fringe benefits.* All laborers and mechanics employed or working upon the site of the work (or otherwise working in construction or development of the project under a development statute), will be paid unconditionally and not less often than once a week, and without subsequent deduction or rebate on any account (except such payroll deductions as are permitted by regulations issued by the Secretary of Labor under the Copeland Act (29 CFR part 3)), the full amount of basic hourly wages and bona fide fringe benefits (or cash equivalents thereof) due at time of payment computed at rates not less than those contained in the wage determination of the Secretary of Labor which is attached hereto and made a part hereof, regardless of any contractual relationship which may be alleged to exist between the contractor and such laborers and mechanics. As provided in paragraphs (d) and (e) of 29 CFR 5.5, the appropriate wage determinations are effective by operation of law even if they have not been attached to the contract. Contributions made or costs reasonably anticipated for bona fide fringe benefits under the Davis-Bacon Act ([40 U.S.C. 3141\(2\)\(B\)](#)) on behalf of laborers or mechanics are considered wages paid to such laborers or mechanics, subject to the provisions of paragraph 1.e. of this section; also, regular contributions made or costs incurred for more than a weekly period (but not less often than quarterly) under plans, funds, or programs which cover the particular weekly period, are deemed to be constructively made or incurred during such weekly period. Such laborers and mechanics must be paid the appropriate wage rate and fringe benefits on the wage determination for the classification(s) of work actually performed, without regard to skill, except as provided in paragraph 4. of this section. Laborers or mechanics performing work in more than one classification may be compensated at the rate specified for each classification for the time actually worked therein: *Provided*, That the employer's payroll records accurately set forth the time spent in each classification in which work is performed. The wage determination (including any additional classifications and wage rates conformed under paragraph 1.c. of this section) and the Davis-Bacon poster (WH-1321) must be posted at all times by the contractor and its subcontractors at the site of the work in a prominent and accessible place where it can be easily seen by the workers.

b. *Frequently recurring classifications.* (1) In addition to wage and fringe benefit rates that have been determined to be prevailing under the procedures set forth in [29 CFR part 1](#), a wage determination may contain, pursuant to § 1.3(f), wage and fringe benefit rates for classifications of laborers and mechanics for which conformance requests are regularly submitted pursuant to paragraph 1.c. of this section, provided that:

(i) The work performed by the classification is not performed by a classification in the wage determination for which a prevailing wage rate has been determined;

(ii) The classification is used in the area by the construction industry; and

(iii) The wage rate for the classification bears a reasonable relationship to the prevailing wage rates contained in the wage determination.

(2) The Administrator will establish wage rates for such classifications in accordance with paragraph 1.c.(1)(iii) of this section. Work performed in such a classification must be paid at no less than the wage and fringe benefit rate listed on the wage determination for such classification.

c. *Conformance.* (1) The contracting officer must require that any class of laborers or mechanics, including helpers, which is not listed in the wage determination and which is to be employed under the contract be classified in conformance with the wage determination. Conformance of an additional classification and wage rate and fringe benefits is appropriate only when the following criteria have been met:

(i) The work to be performed by the classification requested is not performed by a classification in the wage determination; and

(ii) The classification is used in the area by the construction industry; and

(iii) The proposed wage rate, including any bona fide fringe benefits, bears a reasonable relationship to the wage rates contained in the wage determination.

(2) The conformance process may not be used to split, subdivide, or otherwise avoid application of classifications listed in the wage determination.

(3) If the contractor and the laborers and mechanics to be employed in the classification (if known), or their representatives, and the contracting officer agree on the classification and wage rate (including the amount designated for fringe benefits where appropriate), a report of the action taken will be sent by the contracting officer by email to DBAconformance@dol.gov. The Administrator, or an authorized representative, will approve, modify, or disapprove every additional classification action within 30 days of receipt and so advise the contracting officer or will notify the contracting officer within the 30-day period that additional time is necessary.

(4) In the event the contractor, the laborers or mechanics to be employed in the classification or their representatives, and the contracting officer do not agree on the proposed classification and wage rate (including the amount designated for fringe benefits, where appropriate), the contracting officer will, by email to DBAconformance@dol.gov, refer the questions, including the views of all interested parties and the recommendation of the contracting officer, to the Administrator for determination. The Administrator, or an authorized representative, will issue a determination within 30 days of receipt and so advise the contracting officer or will notify the contracting officer within the 30-day period that additional time is necessary.

(5) The contracting officer must promptly notify the contractor of the action taken by the Wage and Hour Division

under paragraphs 1.c.(3) and (4) of this section. The contractor must furnish a written copy of such determination to each affected worker or it must be posted as a part of the wage determination. The wage rate (including fringe benefits where appropriate) determined pursuant to paragraph 1.c.(3) or (4) of this section must be paid to all workers performing work in the classification under this contract from the first day on which work is performed in the classification.

d. *Fringe benefits not expressed as an hourly rate.* Whenever the minimum wage rate prescribed in the contract for a class of laborers or mechanics includes a fringe benefit which is not expressed as an hourly rate, the contractor may either pay the benefit as stated in the wage determination or may pay another bona fide fringe benefit or an hourly cash equivalent thereof.

e. *Unfunded plans.* If the contractor does not make payments to a trustee or other third person, the contractor may consider as part of the wages of any laborer or mechanic the amount of any costs reasonably anticipated in providing bona fide fringe benefits under a plan or program, *Provided*, That the Secretary of Labor has found, upon the written request of the contractor, in accordance with the criteria set forth in § 5.28, that the applicable standards of the Davis-Bacon Act have been met. The Secretary of Labor may require the contractor to set aside in a separate account assets for the meeting of obligations under the plan or program.

f. *Interest.* In the event of a failure to pay all or part of the wages required by the contract, the contractor will be required to pay interest on any underpayment of wages.

2. Withholding (29 CFR 5.5)

a. *Withholding requirements.* The contracting agency may, upon its own action, or must, upon written request of an authorized representative of the Department of Labor, withhold or cause to be withheld from the contractor so much of the accrued payments or advances as may be considered necessary to satisfy the liabilities of the prime contractor or any subcontractor for the full amount of wages and monetary relief, including interest, required by the clauses set forth in this section for violations of this contract, or to satisfy any such liabilities required by any other Federal contract, or federally assisted contract subject to Davis-Bacon labor standards, that is held by the same prime contractor (as defined in § 5.2). The necessary funds may be withheld from the contractor under this contract, any other Federal contract with the same prime contractor, or any other federally assisted contract that is subject to Davis-Bacon labor standards requirements and is held by the same prime contractor, regardless of whether the other contract was awarded or assisted by the same agency, and such funds may be used to satisfy the contractor liability for which the funds were withheld. In the event of a contractor's failure to pay any laborer or mechanic, including any apprentice or helper working on the site of the work all or part of the wages required by the contract, or upon the contractor's failure to submit the required records as discussed in paragraph 3.d. of this section, the contracting agency may on its own initiative and after written notice to the contractor, take such action as may be necessary to cause the suspension of any further payment, advance, or guarantee of funds until such violations have ceased.

b. *Priority to withheld funds.* The Department has priority to funds withheld or to be withheld in accordance with paragraph

2.a. of this section or Section V, paragraph 3.a., or both, over claims to those funds by:

- (1) A contractor's surety(ies), including without limitation performance bond sureties and payment bond sureties;
- (2) A contracting agency for its reprocurement costs;
- (3) A trustee(s) (either a court-appointed trustee or a U.S. trustee, or both) in bankruptcy of a contractor, or a contractor's bankruptcy estate;
- (4) A contractor's assignee(s);
- (5) A contractor's successor(s); or
- (6) A claim asserted under the Prompt Payment Act, 31 U.S.C. 3901-3907.

3. Records and certified payrolls (29 CFR 5.5)

a. *Basic record requirements* (1) *Length of record retention*. All regular payrolls and other basic records must be maintained by the contractor and any subcontractor during the course of the work and preserved for all laborers and mechanics working at the site of the work (or otherwise working in construction or development of the project under a development statute) for a period of at least 3 years after all the work on the prime contract is completed.

(2) *Information required*. Such records must contain the name; Social Security number; last known address, telephone number, and email address of each such worker; each worker's correct classification(s) of work actually performed; hourly rates of wages paid (including rates of contributions or costs anticipated for bona fide fringe benefits or cash equivalents thereof of the types described in 40 U.S.C. 3141(2)(B) of the Davis-Bacon Act); daily and weekly number of hours actually worked in total and on each covered contract; deductions made; and actual wages paid.

(3) *Additional records relating to fringe benefits*. Whenever the Secretary of Labor has found under paragraph 1.e. of this section that the wages of any laborer or mechanic include the amount of any costs reasonably anticipated in providing benefits under a plan or program described in 40 U.S.C. 3141(2)(B) of the Davis-Bacon Act, the contractor must maintain records which show that the commitment to provide such benefits is enforceable, that the plan or program is financially responsible, and that the plan or program has been communicated in writing to the laborers or mechanics affected, and records which show the costs anticipated or the actual cost incurred in providing such benefits.

(4) *Additional records relating to apprenticeship*. Contractors with apprentices working under approved programs must maintain written evidence of the registration of apprenticeship programs, the registration of the apprentices, and the ratios and wage rates prescribed in the applicable programs.

b. *Certified payroll requirements* (1) *Frequency and method of submission*. The contractor or subcontractor must submit weekly, for each week in which any DBA- or Related Acts-covered work is performed, certified payrolls to the contracting

agency. The prime contractor is responsible for the submission of all certified payrolls by all subcontractors. A contracting agency or prime contractor may permit or require contractors to submit certified payrolls through an electronic system, as long as the electronic system requires a legally valid electronic signature; the system allows the contractor, the contracting agency, and the Department of Labor to access the certified payrolls upon request for at least 3 years after the work on the prime contract has been completed; and the contracting agency or prime contractor permits other methods of submission in situations where the contractor is unable or limited in its ability to use or access the electronic system.

(2) *Information required*. The certified payrolls submitted must set out accurately and completely all of the information required to be maintained under paragraph 3.a.(2) of this section, except that full Social Security numbers and last known addresses, telephone numbers, and email addresses must not be included on weekly transmittals. Instead, the certified payrolls need only include an individually identifying number for each worker (e.g., the last four digits of the worker's Social Security number). The required weekly certified payroll information may be submitted using Optional Form WH-347 or in any other format desired. Optional Form WH-347 is available for this purpose from the Wage and Hour Division website at <https://www.dol.gov/sites/dolgov/files/WHD/legacy/files/wh347.pdf> or its successor website. It is not a violation of this section for a prime contractor to require a subcontractor to provide full Social Security numbers and last known addresses, telephone numbers, and email addresses to the prime contractor for its own records, without weekly submission by the subcontractor to the contracting agency.

(3) *Statement of Compliance*. Each certified payroll submitted must be accompanied by a "Statement of Compliance," signed by the contractor or subcontractor, or the contractor's or subcontractor's agent who pays or supervises the payment of the persons working on the contract, and must certify the following:

(i) That the certified payroll for the payroll period contains the information required to be provided under paragraph 3.b. of this section, the appropriate information and basic records are being maintained under paragraph 3.a. of this section, and such information and records are correct and complete;

(ii) That each laborer or mechanic (including each helper and apprentice) working on the contract during the payroll period has been paid the full weekly wages earned, without rebate, either directly or indirectly, and that no deductions have been made either directly or indirectly from the full wages earned, other than permissible deductions as set forth in 29 CFR part 3; and

(iii) That each laborer or mechanic has been paid not less than the applicable wage rates and fringe benefits or cash equivalents for the classification(s) of work actually performed, as specified in the applicable wage determination incorporated into the contract.

(4) *Use of Optional Form WH-347*. The weekly submission of a properly executed certification set forth on the reverse side of Optional Form WH-347 will satisfy the requirement for submission of the "Statement of Compliance" required by paragraph 3.b.(3) of this section.

(5) *Signature.* The signature by the contractor, subcontractor, or the contractor's or subcontractor's agent must be an original handwritten signature or a legally valid electronic signature.

(6) *Falsification.* The falsification of any of the above certifications may subject the contractor or subcontractor to civil or criminal prosecution under [18 U.S.C. 1001](#) and [31 U.S.C. 3729](#).

(7) *Length of certified payroll retention.* The contractor or subcontractor must preserve all certified payrolls during the course of the work and for a period of 3 years after all the work on the prime contract is completed.

c. *Contracts, subcontracts, and related documents.* The contractor or subcontractor must maintain this contract or subcontract and related documents including, without limitation, bids, proposals, amendments, modifications, and extensions. The contractor or subcontractor must preserve these contracts, subcontracts, and related documents during the course of the work and for a period of 3 years after all the work on the prime contract is completed.

d. *Required disclosures and access (1) Required record disclosures and access to workers.* The contractor or subcontractor must make the records required under paragraphs 3.a. through 3.c. of this section, and any other documents that the contracting agency, the State DOT, the FHWA, or the Department of Labor deems necessary to determine compliance with the labor standards provisions of any of the applicable statutes referenced by § 5.1, available for inspection, copying, or transcription by authorized representatives of the contracting agency, the State DOT, the FHWA, or the Department of Labor, and must permit such representatives to interview workers during working hours on the job.

(2) *Sanctions for non-compliance with records and worker access requirements.* If the contractor or subcontractor fails to submit the required records or to make them available, or refuses to permit worker interviews during working hours on the job, the Federal agency may, after written notice to the contractor, sponsor, applicant, owner, or other entity, as the case may be, that maintains such records or that employs such workers, take such action as may be necessary to cause the suspension of any further payment, advance, or guarantee of funds. Furthermore, failure to submit the required records upon request or to make such records available, or to permit worker interviews during working hours on the job, may be grounds for debarment action pursuant to § 5.12. In addition, any contractor or other person that fails to submit the required records or make those records available to WHD within the time WHD requests that the records be produced will be precluded from introducing as evidence in an administrative proceeding under [29 CFR part 6](#) any of the required records that were not provided or made available to WHD. WHD will take into consideration a reasonable request from the contractor or person for an extension of the time for submission of records. WHD will determine the reasonableness of the request and may consider, among other things, the location of the records and the volume of production.

(3) *Required information disclosures.* Contractors and subcontractors must maintain the full Social Security number and last known address, telephone number, and email address

of each covered worker, and must provide them upon request to the contracting agency, the State DOT, the FHWA, the contractor, or the Wage and Hour Division of the Department of Labor for purposes of an investigation or other compliance action.

4. Apprentices and equal employment opportunity (29 CFR 5.5)

a. *Apprentices (1) Rate of pay.* Apprentices will be permitted to work at less than the predetermined rate for the work they perform when they are employed pursuant to and individually registered in a bona fide apprenticeship program registered with the U.S. Department of Labor, Employment and Training Administration, Office of Apprenticeship (OA), or with a State Apprenticeship Agency recognized by the OA. A person who is not individually registered in the program, but who has been certified by the OA or a State Apprenticeship Agency (where appropriate) to be eligible for probationary employment as an apprentice, will be permitted to work at less than the predetermined rate for the work they perform in the first 90 days of probationary employment as an apprentice in such a program. In the event the OA or a State Apprenticeship Agency recognized by the OA withdraws approval of an apprenticeship program, the contractor will no longer be permitted to use apprentices at less than the applicable predetermined rate for the work performed until an acceptable program is approved.

(2) *Fringe benefits.* Apprentices must be paid fringe benefits in accordance with the provisions of the apprenticeship program. If the apprenticeship program does not specify fringe benefits, apprentices must be paid the full amount of fringe benefits listed on the wage determination for the applicable classification. If the Administrator determines that a different practice prevails for the applicable apprentice classification, fringe benefits must be paid in accordance with that determination.

(3) *Apprenticeship ratio.* The allowable ratio of apprentices to journeyworkers on the job site in any craft classification must not be greater than the ratio permitted to the contractor as to the entire work force under the registered program or the ratio applicable to the locality of the project pursuant to paragraph 4.a.(4) of this section. Any worker listed on a payroll at an apprentice wage rate, who is not registered or otherwise employed as stated in paragraph 4.a.(1) of this section, must be paid not less than the applicable wage rate on the wage determination for the classification of work actually performed. In addition, any apprentice performing work on the job site in excess of the ratio permitted under this section must be paid not less than the applicable wage rate on the wage determination for the work actually performed.

(4) *Reciprocity of ratios and wage rates.* Where a contractor is performing construction on a project in a locality other than the locality in which its program is registered, the ratios and wage rates (expressed in percentages of the journeyworker's hourly rate) applicable within the locality in which the construction is being performed must be observed. If there is no applicable ratio or wage rate for the locality of the project, the ratio and wage rate specified in the contractor's registered program must be observed.

b. *Equal employment opportunity.* The use of apprentices and journeyworkers under this part must be in conformity with

the equal employment opportunity requirements of Executive Order 11246, as amended, and [29 CFR part 30](#).

c. Apprentices and Trainees (programs of the U.S. DOT).

Apprentices and trainees working under apprenticeship and skill training programs which have been certified by the Secretary of Transportation as promoting EEO in connection with Federal-aid highway construction programs are not subject to the requirements of paragraph 4 of this Section IV. 23 CFR 230.111(e)(2). The straight time hourly wage rates for apprentices and trainees under such programs will be established by the particular programs. The ratio of apprentices and trainees to journeyworkers shall not be greater than permitted by the terms of the particular program.

5. Compliance with Copeland Act requirements. The contractor shall comply with the requirements of 29 CFR part 3, which are incorporated by reference in this contract as provided in 29 CFR 5.5.

6. Subcontracts. The contractor or subcontractor must insert FHWA-1273 in any subcontracts, along with the applicable wage determination(s) and such other clauses or contract modifications as the contracting agency may by appropriate instructions require, and a clause requiring the subcontractors to include these clauses and wage determination(s) in any lower tier subcontracts. The prime contractor is responsible for the compliance by any subcontractor or lower tier subcontractor with all the contract clauses in this section. In the event of any violations of these clauses, the prime contractor and any subcontractor(s) responsible will be liable for any unpaid wages and monetary relief, including interest from the date of the underpayment or loss, due to any workers of lower-tier subcontractors, and may be subject to debarment, as appropriate. 29 CFR 5.5.

7. Contract termination: debarment. A breach of the contract clauses in 29 CFR 5.5 may be grounds for termination of the contract, and for debarment as a contractor and a subcontractor as provided in 29 CFR 5.12.

8. Compliance with Davis-Bacon and Related Act requirements. All rulings and interpretations of the Davis-Bacon and Related Acts contained in 29 CFR parts 1, 3, and 5 are herein incorporated by reference in this contract as provided in 29 CFR 5.5.

9. Disputes concerning labor standards. As provided in 29 CFR 5.5, disputes arising out of the labor standards provisions of this contract shall not be subject to the general disputes clause of this contract. Such disputes shall be resolved in accordance with the procedures of the Department of Labor set forth in 29 CFR parts 5, 6, and 7. Disputes within the meaning of this clause include disputes between the contractor (or any of its subcontractors) and the contracting agency, the U.S. Department of Labor, or the employees or their representatives.

10. Certification of eligibility. a. By entering into this contract, the contractor certifies that neither it nor any person or firm who has an interest in the contractor's firm is a person or firm ineligible to be awarded Government contracts by virtue of [40 U.S.C. 3144\(b\)](#) or § 5.12(a).

b. No part of this contract shall be subcontracted to any person or firm ineligible for award of a Government contract by virtue of [40 U.S.C. 3144\(b\)](#) or § 5.12(a).

c. The penalty for making false statements is prescribed in the U.S. Code, Title 18 Crimes and Criminal Procedure, [18 U.S.C. 1001](#).

11. Anti-retaliation. It is unlawful for any person to discharge, demote, intimidate, threaten, restrain, coerce, blacklist, harass, or in any other manner discriminate against, or to cause any person to discharge, demote, intimidate, threaten, restrain, coerce, blacklist, harass, or in any other manner discriminate against, any worker or job applicant for:

a. Notifying any contractor of any conduct which the worker reasonably believes constitutes a violation of the DBA, Related Acts, this part, or [29 CFR part 1](#) or [3](#);

b. Filing any complaint, initiating or causing to be initiated any proceeding, or otherwise asserting or seeking to assert on behalf of themselves or others any right or protection under the DBA, Related Acts, this part, or [29 CFR part 1](#) or [3](#);

c. Cooperating in any investigation or other compliance action, or testifying in any proceeding under the DBA, Related Acts, this part, or [29 CFR part 1](#) or [3](#); or

d. Informing any other person about their rights under the DBA, Related Acts, this part, or [29 CFR part 1](#) or [3](#).

V. CONTRACT WORK HOURS AND SAFETY STANDARDS ACT

Pursuant to 29 CFR 5.5(b), the following clauses apply to any Federal-aid construction contract in an amount in excess of \$100,000 and subject to the overtime provisions of the Contract Work Hours and Safety Standards Act. These clauses shall be inserted in addition to the clauses required by 29 CFR 5.5(a) or 29 CFR 4.6. As used in this paragraph, the terms laborers and mechanics include watchpersons and guards.

1. Overtime requirements. No contractor or subcontractor contracting for any part of the contract work which may require or involve the employment of laborers or mechanics shall require or permit any such laborer or mechanic in any workweek in which he or she is employed on such work to work in excess of forty hours in such workweek unless such laborer or mechanic receives compensation at a rate not less than one and one-half times the basic rate of pay for all hours worked in excess of forty hours in such workweek. 29 CFR 5.5.

2. Violation; liability for unpaid wages; liquidated damages. In the event of any violation of the clause set forth in paragraph 1. of this section the contractor and any subcontractor responsible therefor shall be liable for the unpaid wages and interest from the date of the underpayment. In addition, such contractor and subcontractor shall be liable to the United States (in the case of work done under contract for the District of Columbia or a territory, to such District or to such territory), for liquidated damages. Such liquidated damages shall be computed with respect to each individual laborer or

mechanic, including watchpersons and guards, employed in violation of the clause set forth in paragraph 1. of this section, in the sum currently provided in 29 CFR 5.5(b)(2)* for each calendar day on which such individual was required or permitted to work in excess of the standard workweek of forty hours without payment of the overtime wages required by the clause set forth in paragraph 1. of this section.

* \$31 as of January 15, 2023 (See 88 FR 88 FR 2210) as may be adjusted annually by the Department of Labor, pursuant to the Federal Civil Penalties Inflation Adjustment Act of 1990.

3. Withholding for unpaid wages and liquidated damages

a. *Withholding process.* The FHWA or the contracting agency may, upon its own action, or must, upon written request of an authorized representative of the Department of Labor, withhold or cause to be withheld from the contractor so much of the accrued payments or advances as may be considered necessary to satisfy the liabilities of the prime contractor or any subcontractor for any unpaid wages; monetary relief, including interest; and liquidated damages required by the clauses set forth in this section on this contract, any other Federal contract with the same prime contractor, or any other federally assisted contract subject to the Contract Work Hours and Safety Standards Act that is held by the same prime contractor (as defined in § 5.2). The necessary funds may be withheld from the contractor under this contract, any other Federal contract with the same prime contractor, or any other federally assisted contract that is subject to the Contract Work Hours and Safety Standards Act and is held by the same prime contractor, regardless of whether the other contract was awarded or assisted by the same agency, and such funds may be used to satisfy the contractor liability for which the funds were withheld.

b. *Priority to withheld funds.* The Department has priority to funds withheld or to be withheld in accordance with Section IV paragraph 2.a. or paragraph 3.a. of this section, or both, over claims to those funds by:

- (1) A contractor's surety(ies), including without limitation performance bond sureties and payment bond sureties;
- (2) A contracting agency for its reprourement costs;
- (3) A trustee(s) (either a court-appointed trustee or a U.S. trustee, or both) in bankruptcy of a contractor, or a contractor's bankruptcy estate;
- (4) A contractor's assignee(s);
- (5) A contractor's successor(s); or
- (6) A claim asserted under the Prompt Payment Act, [31 U.S.C. 3901–3907](#).

4. Subcontracts. The contractor or subcontractor must insert in any subcontracts the clauses set forth in paragraphs 1. through 5. of this section and a clause requiring the subcontractors to include these clauses in any lower tier subcontracts. The prime contractor is responsible for compliance by any subcontractor or lower tier subcontractor with the clauses set forth in paragraphs 1. through 5. In the

event of any violations of these clauses, the prime contractor and any subcontractor(s) responsible will be liable for any unpaid wages and monetary relief, including interest from the date of the underpayment or loss, due to any workers of lower-tier subcontractors, and associated liquidated damages and may be subject to debarment, as appropriate.

5. Anti-retaliation. It is unlawful for any person to discharge, demote, intimidate, threaten, restrain, coerce, blacklist, harass, or in any other manner discriminate against, or to cause any person to discharge, demote, intimidate, threaten, restrain, coerce, blacklist, harass, or in any other manner discriminate against, any worker or job applicant for:

- a. Notifying any contractor of any conduct which the worker reasonably believes constitutes a violation of the Contract Work Hours and Safety Standards Act (CWHSSA) or its implementing regulations in this part;
- b. Filing any complaint, initiating or causing to be initiated any proceeding, or otherwise asserting or seeking to assert on behalf of themselves or others any right or protection under CWHSSA or this part;
- c. Cooperating in any investigation or other compliance action, or testifying in any proceeding under CWHSSA or this part; or
- d. Informing any other person about their rights under CWHSSA or this part.

VI. SUBLETTING OR ASSIGNING THE CONTRACT

This provision is applicable to all Federal-aid construction contracts on the National Highway System pursuant to 23 CFR 635.116.

1. The contractor shall perform with its own organization contract work amounting to not less than 30 percent (or a greater percentage if specified elsewhere in the contract) of the total original contract price, excluding any specialty items designated by the contracting agency. Specialty items may be performed by subcontract and the amount of any such specialty items performed may be deducted from the total original contract price before computing the amount of work required to be performed by the contractor's own organization (23 CFR 635.116).

a. The term "perform work with its own organization" in paragraph 1 of Section VI refers to workers employed or leased by the prime contractor, and equipment owned or rented by the prime contractor, with or without operators. Such term does not include employees or equipment of a subcontractor or lower tier subcontractor, agents of the prime contractor, or any other assignees. The term may include payments for the costs of hiring leased employees from an employee leasing firm meeting all relevant Federal and State regulatory requirements. Leased employees may only be included in this term if the prime contractor meets all of the following conditions: (based on longstanding interpretation)

- (1) the prime contractor maintains control over the supervision of the day-to-day activities of the leased employees;
- (2) the prime contractor remains responsible for the quality of the work of the leased employees;

- (3) the prime contractor retains all power to accept or exclude individual employees from work on the project; and
- (4) the prime contractor remains ultimately responsible for the payment of predetermined minimum wages, the submission of payrolls, statements of compliance and all other Federal regulatory requirements.

b. "Specialty Items" shall be construed to be limited to work that requires highly specialized knowledge, abilities, or equipment not ordinarily available in the type of contracting organizations qualified and expected to bid or propose on the contract as a whole and in general are to be limited to minor components of the overall contract. 23 CFR 635.102.

2. Pursuant to 23 CFR 635.116(a), the contract amount upon which the requirements set forth in paragraph (1) of Section VI is computed includes the cost of material and manufactured products which are to be purchased or produced by the contractor under the contract provisions.

3. Pursuant to 23 CFR 635.116(c), the contractor shall furnish (a) a competent superintendent or supervisor who is employed by the firm, has full authority to direct performance of the work in accordance with the contract requirements, and is in charge of all construction operations (regardless of who performs the work) and (b) such other of its own organizational resources (supervision, management, and engineering services) as the contracting officer determines is necessary to assure the performance of the contract.

4. No portion of the contract shall be sublet, assigned or otherwise disposed of except with the written consent of the contracting officer, or authorized representative, and such consent when given shall not be construed to relieve the contractor of any responsibility for the fulfillment of the contract. Written consent will be given only after the contracting agency has assured that each subcontract is evidenced in writing and that it contains all pertinent provisions and requirements of the prime contract. (based on long-standing interpretation of 23 CFR 635.116).

5. The 30-percent self-performance requirement of paragraph (1) is not applicable to design-build contracts; however, contracting agencies may establish their own self-performance requirements. 23 CFR 635.116(d).

VII. SAFETY: ACCIDENT PREVENTION

This provision is applicable to all Federal-aid construction contracts and to all related subcontracts.

1. In the performance of this contract the contractor shall comply with all applicable Federal, State, and local laws governing safety, health, and sanitation (23 CFR Part 635). The contractor shall provide all safeguards, safety devices and protective equipment and take any other needed actions as it determines, or as the contracting officer may determine, to be reasonably necessary to protect the life and health of employees on the job and the safety of the public and to protect property in connection with the performance of the work covered by the contract. 23 CFR 635.108.

2. It is a condition of this contract, and shall be made a condition of each subcontract, which the contractor enters into pursuant to this contract, that the contractor and any subcontractor shall not permit any employee, in performance of the contract, to work in surroundings or under conditions which are unsanitary, hazardous or dangerous to his/her health or safety, as determined under construction safety and

health standards (29 CFR Part 1926) promulgated by the Secretary of Labor, in accordance with Section 107 of the Contract Work Hours and Safety Standards Act (40 U.S.C. 3704). 29 CFR 1926.10.

3. Pursuant to 29 CFR 1926.3, it is a condition of this contract that the Secretary of Labor or authorized representative thereof, shall have right of entry to any site of contract performance to inspect or investigate the matter of compliance with the construction safety and health standards and to carry out the duties of the Secretary under Section 107 of the Contract Work Hours and Safety Standards Act (40 U.S.C. 3704).

VIII. FALSE STATEMENTS CONCERNING HIGHWAY PROJECTS

This provision is applicable to all Federal-aid construction contracts and to all related subcontracts.

In order to assure high quality and durable construction in conformity with approved plans and specifications and a high degree of reliability on statements and representations made by engineers, contractors, suppliers, and workers on Federal-aid highway projects, it is essential that all persons concerned with the project perform their functions as carefully, thoroughly, and honestly as possible. Willful falsification, distortion, or misrepresentation with respect to any facts related to the project is a violation of Federal law. To prevent any misunderstanding regarding the seriousness of these and similar acts, Form FHWA-1022 shall be posted on each Federal-aid highway project (23 CFR Part 635) in one or more places where it is readily available to all persons concerned with the project:

18 U.S.C. 1020 reads as follows:

"Whoever, being an officer, agent, or employee of the United States, or of any State or Territory, or whoever, whether a person, association, firm, or corporation, knowingly makes any false statement, false representation, or false report as to the character, quality, quantity, or cost of the material used or to be used, or the quantity or quality of the work performed or to be performed, or the cost thereof in connection with the submission of plans, maps, specifications, contracts, or costs of construction on any highway or related project submitted for approval to the Secretary of Transportation; or

Whoever knowingly makes any false statement, false representation, false report or false claim with respect to the character, quality, quantity, or cost of any work performed or to be performed, or materials furnished or to be furnished, in connection with the construction of any highway or related project approved by the Secretary of Transportation; or

Whoever knowingly makes any false statement or false representation as to material fact in any statement, certificate, or report submitted pursuant to provisions of the Federal-aid Roads Act approved July 11, 1916, (39 Stat. 355), as amended and supplemented;

Shall be fined under this title or imprisoned not more than 5 years or both."

IX. IMPLEMENTATION OF CLEAN AIR ACT AND FEDERAL WATER POLLUTION CONTROL ACT (42 U.S.C. 7606; 2 CFR 200.88; EO 11738)

This provision is applicable to all Federal-aid construction contracts in excess of \$150,000 and to all related subcontracts. 48 CFR 2.101; 2 CFR 200.327.

By submission of this bid/proposal or the execution of this contract or subcontract, as appropriate, the bidder, proposer, Federal-aid construction contractor, subcontractor, supplier, or vendor agrees to comply with all applicable standards, orders or regulations issued pursuant to the Clean Air Act (42 U.S.C. 7401-7671q) and the Federal Water Pollution Control Act, as amended (33 U.S.C. 1251-1387). Violations must be reported to the Federal Highway Administration and the Regional Office of the Environmental Protection Agency. 2 CFR Part 200, Appendix II.

The contractor agrees to include or cause to be included the requirements of this Section in every subcontract, and further agrees to take such action as the contracting agency may direct as a means of enforcing such requirements. 2 CFR 200.327.

X. CERTIFICATION REGARDING DEBARMENT, SUSPENSION, INELIGIBILITY AND VOLUNTARY EXCLUSION

This provision is applicable to all Federal-aid construction contracts, design-build contracts, subcontracts, lower-tier subcontracts, purchase orders, lease agreements, consultant contracts or any other covered transaction requiring FHWA approval or that is estimated to cost \$25,000 or more – as defined in 2 CFR Parts 180 and 1200. 2 CFR 180.220 and 1200.220.

1. Instructions for Certification – First Tier Participants:

a. By signing and submitting this proposal, the prospective first tier participant is providing the certification set out below.

b. The inability of a person to provide the certification set out below will not necessarily result in denial of participation in this covered transaction. The prospective first tier participant shall submit an explanation of why it cannot provide the certification set out below. The certification or explanation will be considered in connection with the department or agency's determination whether to enter into this transaction. However, failure of the prospective first tier participant to furnish a certification or an explanation shall disqualify such a person from participation in this transaction. 2 CFR 180.320.

c. The certification in this clause is a material representation of fact upon which reliance was placed when the contracting agency determined to enter into this transaction. If it is later determined that the prospective participant knowingly rendered an erroneous certification, in addition to other remedies available to the Federal Government, the contracting agency may terminate this transaction for cause of default. 2 CFR 180.325.

d. The prospective first tier participant shall provide immediate written notice to the contracting agency to whom this proposal is submitted if any time the prospective first tier participant learns that its certification was erroneous when submitted or has become erroneous by reason of changed circumstances. 2 CFR 180.345 and 180.350.

e. The terms "covered transaction," "debarred," "suspended," "ineligible," "participant," "person," "principal," and "voluntarily excluded," as used in this clause, are defined in 2 CFR Parts 180, Subpart I, 180.900-180.1020, and 1200. "First Tier Covered Transactions" refers to any covered transaction between a recipient or subrecipient of Federal funds and a participant (such as the prime or general contract). "Lower Tier Covered Transactions" refers to any covered transaction under a First Tier Covered Transaction (such as subcontracts). "First Tier Participant" refers to the participant who has entered into a covered transaction with a recipient or subrecipient of Federal funds (such as the prime or general contractor). "Lower Tier Participant" refers any participant who has entered into a covered transaction with a First Tier Participant or other Lower Tier Participants (such as subcontractors and suppliers).

f. The prospective first tier participant agrees by submitting this proposal that, should the proposed covered transaction be entered into, it shall not knowingly enter into any lower tier covered transaction with a person who is debarred, suspended, declared ineligible, or voluntarily excluded from participation in this covered transaction, unless authorized by the department or agency entering into this transaction. 2 CFR 180.330.

g. The prospective first tier participant further agrees by submitting this proposal that it will include the clause titled "Certification Regarding Debarment, Suspension, Ineligibility and Voluntary Exclusion-Lower Tier Covered Transactions," provided by the department or contracting agency, entering into this covered transaction, without modification, in all lower tier covered transactions and in all solicitations for lower tier covered transactions exceeding the \$25,000 threshold. 2 CFR 180.220 and 180.300.

h. A participant in a covered transaction may rely upon a certification of a prospective participant in a lower tier covered transaction that is not debarred, suspended, ineligible, or voluntarily excluded from the covered transaction, unless it knows that the certification is erroneous. 2 CFR 180.300; 180.320, and 180.325. A participant is responsible for ensuring that its principals are not suspended, debarred, or otherwise ineligible to participate in covered transactions. 2 CFR 180.335. To verify the eligibility of its principals, as well as the eligibility of any lower tier prospective participants, each participant may, but is not required to, check the System for Award Management website (<https://www.sam.gov/>). 2 CFR 180.300, 180.320, and 180.325.

i. Nothing contained in the foregoing shall be construed to require the establishment of a system of records in order to render in good faith the certification required by this clause. The knowledge and information of the prospective participant is not required to exceed that which is normally possessed by a prudent person in the ordinary course of business dealings.

j. Except for transactions authorized under paragraph (f) of these instructions, if a participant in a covered transaction knowingly enters into a lower tier covered transaction with a person who is suspended, debarred, ineligible, or voluntarily excluded from participation in this transaction, in addition to other remedies available to the Federal Government, the department or agency may terminate this transaction for cause or default. 2 CFR 180.325.

2. Certification Regarding Debarment, Suspension, Ineligibility and Voluntary Exclusion – First Tier Participants:

a. The prospective first tier participant certifies to the best of its knowledge and belief, that it and its principals:

(1) Are not presently debarred, suspended, proposed for debarment, declared ineligible, or voluntarily excluded from participating in covered transactions by any Federal department or agency, 2 CFR 180.335;.

(2) Have not within a three-year period preceding this proposal been convicted of or had a civil judgment rendered against them for commission of fraud or a criminal offense in connection with obtaining, attempting to obtain, or performing a public (Federal, State, or local) transaction or contract under a public transaction; violation of Federal or State antitrust statutes or commission of embezzlement, theft, forgery, bribery, falsification or destruction of records, making false statements, or receiving stolen property, 2 CFR 180.800;

(3) Are not presently indicted for or otherwise criminally or civilly charged by a governmental entity (Federal, State or local) with commission of any of the offenses enumerated in paragraph (a)(2) of this certification, 2 CFR 180.700 and 180.800; and

(4) Have not within a three-year period preceding this application/proposal had one or more public transactions (Federal, State or local) terminated for cause or default. 2 CFR 180.335(d).

(5) Are not a corporation that has been convicted of a felony violation under any Federal law within the two-year period preceding this proposal (USDOT Order 4200.6 implementing appropriations act requirements); and

(6) Are not a corporation with any unpaid Federal tax liability that has been assessed, for which all judicial and administrative remedies have been exhausted, or have lapsed, and that is not being paid in a timely manner pursuant to an agreement with the authority responsible for collecting the tax liability (USDOT Order 4200.6 implementing appropriations act requirements).

b. Where the prospective participant is unable to certify to any of the statements in this certification, such prospective participant should attach an explanation to this proposal. 2 CFR 180.335 and 180.340.

3. Instructions for Certification - Lower Tier Participants:

(Applicable to all subcontracts, purchase orders, and other lower tier transactions requiring prior FHWA approval or estimated to cost \$25,000 or more - 2 CFR Parts 180 and 1200). 2 CFR 180.220 and 1200.220.

a. By signing and submitting this proposal, the prospective lower tier participant is providing the certification set out below.

b. The certification in this clause is a material representation of fact upon which reliance was placed when this transaction was entered into. If it is later determined that the prospective lower tier participant knowingly rendered an erroneous certification, in addition to other remedies available to the Federal Government, the department, or agency with which

this transaction originated may pursue available remedies, including suspension and/or debarment.

c. The prospective lower tier participant shall provide immediate written notice to the person to which this proposal is submitted if at any time the prospective lower tier participant learns that its certification was erroneous by reason of changed circumstances. 2 CFR 180.365.

d. The terms "covered transaction," "debarred," "suspended," "ineligible," "participant," "person," "principal," and "voluntarily excluded," as used in this clause, are defined in 2 CFR Parts 180, Subpart I, 180.900 – 180.1020, and 1200. You may contact the person to which this proposal is submitted for assistance in obtaining a copy of those regulations. "First Tier Covered Transactions" refers to any covered transaction between a recipient or subrecipient of Federal funds and a participant (such as the prime or general contract). "Lower Tier Covered Transactions" refers to any covered transaction under a First Tier Covered Transaction (such as subcontracts). "First Tier Participant" refers to the participant who has entered into a covered transaction with a recipient or subrecipient of Federal funds (such as the prime or general contractor). "Lower Tier Participant" refers any participant who has entered into a covered transaction with a First Tier Participant or other Lower Tier Participants (such as subcontractors and suppliers).

e. The prospective lower tier participant agrees by submitting this proposal that, should the proposed covered transaction be entered into, it shall not knowingly enter into any lower tier covered transaction with a person who is debarred, suspended, declared ineligible, or voluntarily excluded from participation in this covered transaction, unless authorized by the department or agency with which this transaction originated. 2 CFR 1200.220 and 1200.332.

f. The prospective lower tier participant further agrees by submitting this proposal that it will include this clause titled "Certification Regarding Debarment, Suspension, Ineligibility and Voluntary Exclusion-Lower Tier Covered Transaction," without modification, in all lower tier covered transactions and in all solicitations for lower tier covered transactions exceeding the \$25,000 threshold. 2 CFR 180.220 and 1200.220.

g. A participant in a covered transaction may rely upon a certification of a prospective participant in a lower tier covered transaction that is not debarred, suspended, ineligible, or voluntarily excluded from the covered transaction, unless it knows that the certification is erroneous. A participant is responsible for ensuring that its principals are not suspended, debarred, or otherwise ineligible to participate in covered transactions. To verify the eligibility of its principals, as well as the eligibility of any lower tier prospective participants, each participant may, but is not required to, check the System for Award Management website (<https://www.sam.gov/>), which is compiled by the General Services Administration. 2 CFR 180.300, 180.320, 180.330, and 180.335.

h. Nothing contained in the foregoing shall be construed to require establishment of a system of records in order to render in good faith the certification required by this clause. The knowledge and information of participant is not required to exceed that which is normally possessed by a prudent person in the ordinary course of business dealings.

i. Except for transactions authorized under paragraph e of these instructions, if a participant in a covered transaction knowingly enters into a lower tier covered transaction with a person who is suspended, debarred, ineligible, or voluntarily

excluded from participation in this transaction, in addition to other remedies available to the Federal Government, the department or agency with which this transaction originated may pursue available remedies, including suspension and/or debarment. 2 CFR 180.325.

* * * * *

4. Certification Regarding Debarment, Suspension, Ineligibility and Voluntary Exclusion--Lower Tier Participants:

a. The prospective lower tier participant certifies, by submission of this proposal, that neither it nor its principals:

(1) is presently debarred, suspended, proposed for debarment, declared ineligible, or voluntarily excluded from participating in covered transactions by any Federal department or agency, 2 CFR 180.355;

(2) is a corporation that has been convicted of a felony violation under any Federal law within the two-year period preceding this proposal (USDOT Order 4200.6 implementing appropriations act requirements); and

(3) is a corporation with any unpaid Federal tax liability that has been assessed, for which all judicial and administrative remedies have been exhausted, or have lapsed, and that is not being paid in a timely manner pursuant to an agreement with the authority responsible for collecting the tax liability. (USDOT Order 4200.6 implementing appropriations act requirements)

b. Where the prospective lower tier participant is unable to certify to any of the statements in this certification, such prospective participant should attach an explanation to this proposal.

* * * * *

XI. CERTIFICATION REGARDING USE OF CONTRACT FUNDS FOR LOBBYING

This provision is applicable to all Federal-aid construction contracts and to all related subcontracts which exceed \$100,000. 49 CFR Part 20, App. A.

1. The prospective participant certifies, by signing and submitting this bid or proposal, to the best of his or her knowledge and belief, that:

a. No Federal appropriated funds have been paid or will be paid, by or on behalf of the undersigned, to any person for influencing or attempting to influence an officer or employee of any Federal agency, a Member of Congress, an officer or employee of Congress, or an employee of a Member of Congress in connection with the awarding of any Federal contract, the making of any Federal grant, the making of any Federal loan, the entering into of any cooperative agreement, and the extension, continuation, renewal, amendment, or modification of any Federal contract, grant, loan, or cooperative agreement.

b. If any funds other than Federal appropriated funds have been paid or will be paid to any person for influencing or attempting to influence an officer or employee of any Federal agency, a Member of Congress, an officer or employee of Congress, or an employee of a Member of Congress in connection with this Federal contract, grant, loan, or

cooperative agreement, the undersigned shall complete and submit Standard Form-LLL, "Disclosure Form to Report Lobbying," in accordance with its instructions.

2. This certification is a material representation of fact upon which reliance was placed when this transaction was made or entered into. Submission of this certification is a prerequisite for making or entering into this transaction imposed by 31 U.S.C. 1352. Any person who fails to file the required certification shall be subject to a civil penalty of not less than \$10,000 and not more than \$100,000 for each such failure.

3. The prospective participant also agrees by submitting its bid or proposal that the participant shall require that the language of this certification be included in all lower tier subcontracts, which exceed \$100,000 and that all such recipients shall certify and disclose accordingly.

XII. USE OF UNITED STATES-FLAG VESSELS:

This provision is applicable to all Federal-aid construction contracts, design-build contracts, subcontracts, lower-tier subcontracts, purchase orders, lease agreements, or any other covered transaction. 46 CFR Part 381.

This requirement applies to material or equipment that is acquired for a specific Federal-aid highway project. 46 CFR 381.7. It is not applicable to goods or materials that come into inventories independent of an FHWA funded-contract.

When oceanic shipments (or shipments across the Great Lakes) are necessary for materials or equipment acquired for a specific Federal-aid construction project, the bidder, proposer, contractor, subcontractor, or vendor agrees:

1. To utilize privately owned United States-flag commercial vessels to ship at least 50 percent of the gross tonnage (computed separately for dry bulk carriers, dry cargo liners, and tankers) involved, whenever shipping any equipment, material, or commodities pursuant to this contract, to the extent such vessels are available at fair and reasonable rates for United States-flag commercial vessels. 46 CFR 381.7.

2. To furnish within 20 days following the date of loading for shipments originating within the United States or within 30 working days following the date of loading for shipments originating outside the United States, a legible copy of a rated, 'on-board' commercial ocean bill-of-lading in English for each shipment of cargo described in paragraph (b)(1) of this section to both the Contracting Officer (through the prime contractor in the case of subcontractor bills-of-lading) and to the Office of Cargo and Commercial Sealift (MAR-620), Maritime Administration, Washington, DC 20590. (MARAD requires copies of the ocean carrier's (master) bills of lading, certified onboard, dated, with rates and charges. These bills of lading may contain business sensitive information and therefore may be submitted directly to MARAD by the Ocean Transportation Intermediary on behalf of the contractor). 46 CFR 381.7.

**ATTACHMENT A - EMPLOYMENT AND MATERIALS
PREFERENCE FOR APPALACHIAN DEVELOPMENT
HIGHWAY SYSTEM OR APPALACHIAN LOCAL ACCESS
ROAD CONTRACTS (23 CFR 633, Subpart B, Appendix B)**

This provision is applicable to all Federal-aid projects funded under the Appalachian Regional Development Act of 1965.

1. During the performance of this contract, the contractor undertaking to do work which is, or reasonably may be, done as on-site work, shall give preference to qualified persons who regularly reside in the labor area as designated by the DOL wherein the contract work is situated, or the subregion, or the Appalachian counties of the State wherein the contract work is situated, except:

a. To the extent that qualified persons regularly residing in the area are not available.

b. For the reasonable needs of the contractor to employ supervisory or specially experienced personnel necessary to assure an efficient execution of the contract work.

c. For the obligation of the contractor to offer employment to present or former employees as the result of a lawful collective bargaining contract, provided that the number of nonresident persons employed under this subparagraph (1c) shall not exceed 20 percent of the total number of employees employed by the contractor on the contract work, except as provided in subparagraph (4) below.

2. The contractor shall place a job order with the State Employment Service indicating (a) the classifications of the laborers, mechanics and other employees required to perform the contract work, (b) the number of employees required in each classification, (c) the date on which the participant estimates such employees will be required, and (d) any other pertinent information required by the State Employment Service to complete the job order form. The job order may be placed with the State Employment Service in writing or by telephone. If during the course of the contract work, the information submitted by the contractor in the original job order is substantially modified, the participant shall promptly notify the State Employment Service.

3. The contractor shall give full consideration to all qualified job applicants referred to him by the State Employment Service. The contractor is not required to grant employment to any job applicants who, in his opinion, are not qualified to perform the classification of work required.

4. If, within one week following the placing of a job order by the contractor with the State Employment Service, the State Employment Service is unable to refer any qualified job applicants to the contractor, or less than the number requested, the State Employment Service will forward a certificate to the contractor indicating the unavailability of applicants. Such certificate shall be made a part of the contractor's permanent project records. Upon receipt of this certificate, the contractor may employ persons who do not normally reside in the labor area to fill positions covered by the certificate, notwithstanding the provisions of subparagraph (1c) above.

5. The provisions of 23 CFR 633.207(e) allow the contracting agency to provide a contractual preference for the use of mineral resource materials native to the Appalachian region.

6. The contractor shall include the provisions of Sections 1 through 4 of this Attachment A in every subcontract for work which is, or reasonably may be, done as on-site work.

STANDARD SPECIAL PROVISION**ON-THE-JOB TRAINING**

(10-16-07) (Rev. 4-21-15)

Z-10

Description

The North Carolina Department of Transportation will administer a custom version of the Federal On-the-Job Training (OJT) Program, commonly referred to as the Alternate OJT Program. All contractors (existing and newcomers) will be automatically placed in the Alternate Program. Standard OJT requirements typically associated with individual projects will no longer be applied at the project level. Instead, these requirements will be applicable on an annual basis for each contractor administered by the OJT Program Manager.

On the Job Training shall meet the requirements of 23 CFR 230.107 (b), 23 USC – Section 140, this provision and the On-the-Job Training Program Manual.

The Alternate OJT Program will allow a contractor to train employees on Federal, State and privately funded projects located in North Carolina. However, priority shall be given to training employees on NCDOT Federal-Aid funded projects.

Minorities and Women

Developing, training and upgrading of minorities and women toward journeyman level status is a primary objective of this special training provision. Accordingly, the Contractor shall make every effort to enroll minority and women as trainees to the extent that such persons are available within a reasonable area of recruitment. This training commitment is not intended, and shall not be used, to discriminate against any applicant for training, whether a member of a minority group or not.

Assigning Training Goals

The Department, through the OJT Program Manager, will assign training goals for a calendar year based on the contractors' past three years' activity and the contractors' anticipated upcoming year's activity with the Department. At the beginning of each year, all contractors eligible will be contacted by the Department to determine the number of trainees that will be assigned for the upcoming calendar year. At that time the Contractor shall enter into an agreement with the Department to provide a self-imposed on-the-job training program for the calendar year. This agreement will include a specific number of annual training goals agreed to by both parties. The number of training assignments may range from 1 to 15 per contractor per calendar year. The Contractor shall sign an agreement to fulfill their annual goal for the year.\

Training Classifications

The Contractor shall provide on-the-job training aimed at developing full journeyman level workers in the construction craft/operator positions. Preference shall be given to providing training in the following skilled work classifications:

Equipment Operators	Office Engineers
Truck Drivers	Estimators
Carpenters	Iron / Reinforcing Steel Workers
Concrete Finishers	Mechanics
Pipe Layers	Welders

The Department has established common training classifications and their respective training requirements that may be used by the contractors. However, the classifications established are not all-inclusive. Where the training is oriented toward construction applications, training will be allowed in lower-level management positions such as office engineers and estimators. Contractors shall submit new classifications for specific job functions that their employees are performing. The Department will review and recommend for acceptance to FHWA the new classifications proposed by contractors, if applicable. New classifications shall meet the following requirements:

Proposed training classifications are reasonable and realistic based on the job skill classification needs, and

The number of training hours specified in the training classification is consistent with common practices and provides enough time for the trainee to obtain journeyman level status.

The Contractor may allow trainees to be trained by a subcontractor provided that the Contractor retains primary responsibility for meeting the training and this provision is made applicable to the subcontract. However, only the Contractor will receive credit towards the annual goal for the trainee.

Where feasible, 25 percent of apprentices or trainees in each occupation shall be in their first year of apprenticeship or training. The number of trainees shall be distributed among the work classifications on the basis of the contractor's needs and the availability of journeymen in the various classifications within a reasonable area of recruitment.

No employee shall be employed as a trainee in any classification in which they have successfully completed a training course leading to journeyman level status or in which they have been employed as a journeyman.

Records and Reports

The Contractor shall maintain enrollment, monthly and completion reports documenting company compliance under these contract documents. These documents and any other information as requested shall be submitted to the OJT Program Manager.

Upon completion and graduation of the program, the Contractor shall provide each trainee with a certification Certificate showing the type and length of training satisfactorily completed.

Trainee Interviews

All trainees enrolled in the program will receive an initial and Trainee/Post graduate interview conducted by the OJT program staff.

Trainee Wages

Contractors shall compensate trainees on a graduating pay scale based upon a percentage of the prevailing minimum journeyman wages (Davis-Bacon Act). Minimum pay shall be as follows:

60 percent	of the journeyman wage for the first half of the training period
75 percent	of the journeyman wage for the third quarter of the training period
90 percent	of the journeyman wage for the last quarter of the training period

In no instance shall a trainee be paid less than the local minimum wage. The Contractor shall adhere to the minimum hourly wage rate that will satisfy both the NC Department of Labor (NCDOL) and the Department.

Achieving or Failing to Meet Training Goals

The Contractor will be credited for each trainee employed by him on the contract work who is currently enrolled or becomes enrolled in an approved program and who receives training for at least 50 percent of the specific program requirement. Trainees will be allowed to be transferred between projects if required by the Contractor's scheduled workload to meet training goals.

If a contractor fails to attain their training assignments for the calendar year, they may be taken off the NCDOT's Bidders List.

Measurement and Payment

No compensation will be made for providing required training in accordance with these contract documents.

STANDARD SPECIAL PROVISION
MINIMUM WAGES
GENERAL DECISION NC20240090 01/05/2024 NC90

Z-090

Date: January 5, 2024

General Decision Number: NC20240090 01/05/2024 NC90

Superseded General Decision Numbers: NC20230090

State: North Carolina

Construction Type: HIGHWAY

COUNTIES:

Brunswick	Greene	Onslow
Cumberland	Hoke	Pender
Currituck	Johnston	Pitt
Edgecombe	Nash	Wake
Franklin	New Hanover	Wayne

HIGHWAY CONSTRUCTION PROJECTS (excluding tunnels, building structures in rest area projects & railroad construction; bascule, suspension & spandrel arch bridges designed for commercial navigation, bridges involving marine construction; and other major bridges).

Note: Contracts subject to the Davis-Bacon Act are generally required to pay at least the applicable minimum wage rate required under Executive Order 14026 or Executive Order 13658. Please note that these Executive Orders apply to covered contracts entered into by the federal government that are subject to the Davis-Bacon Act itself, but do not apply to contracts subject only to the Davis-Bacon Related Acts, including those set forth at 29 CFR 5.1(a)(1).

<p>If the contract is entered into on or after January 30, 2022, or the contract is renewed or extended (e.g., an option is exercised) on or after January 30, 2022:</p>	<p>Executive Order 14026 generally applies to the contract.</p> <p>The contractor must pay all covered workers at least \$17.20 per hour (or the applicable wage rate listed on this wage determination, if it is higher) for all hours spent performing on that contract in 2024.</p>
<p>If the contract was awarded on or between January 1, 2015 and January 29, 2022, and the contract is not renewed or extended on or after January 30, 2022:</p>	<p>Executive Order 13658 generally applies to the contract.</p> <p>The contractor must pay all covered workers at least \$12.90 per hour (or the applicable wage rate listed on this wage determination, if it is higher) for all hours spent performing on that contract in 2024.</p>

The applicable Executive Order minimum wage rate will be adjusted annually. If this contract is covered by one of the Executive Orders and a classification considered necessary for

performance of work on the contract does not appear on this wage determination, the contractor must still submit a conformance request.

Additional information on contractor requirements and worker protections under the Executive Orders is available at <http://www.dol.gov/whd/govcontracts>.

Modification Number
0

Publication Date
01/05/2024

SUNC2014-005 11/17/2014

	Rates	Fringes
BLASTER	21.04	
CARPENTER	13.72 **	
CEMENT MASON/CONCRETE FINISHER	14.48 **	
ELECTRICIAN		
Electrician	17.97	
Telecommunications Technician	16.79	.63
IRONWORKER	16.02 **	
LABORER		
Asphalt Raker and Spreader	12.46 **	
Asphalt Screed/Jackman	14.33 **	
Carpenter Tender	12.88 **	
Cement Mason/Concrete Finisher Tender	12.54 **	
Common or General	10.20 **	
Guardrail/Fence Installer	12.87 **	
Pipelayer	12.17 **	
Traffic Signal/Lighting Installer	14.89 **	
PAINTER		
Bridge	24.57	
POWER EQUIPMENT OPERATORS		
Asphalt Broom Tractor	11.85 **	
Bulldozer Fine	17.04 **	
Bulldozer Rough	14.34 **	
Concrete Grinder/Groover	20.34	2.30
Crane Boom Trucks	20.54	
Crane Other	20.08	
Crane Rough/All-Terrain	20.67	
Drill Operator Rock	14.38 **	
Drill Operator Structure	21.14	
Excavator Fine	16.60	
Excavator Rough	14.00 **	
Grader/Blade Fine	18.47	
Grader/Blade Rough	14.62 **	
Loader 2 Cubic Yards or Less	13.76 **	
Loader Greater Than 2 Cubic Yards	14.14 **	
Material Transfer Vehicle (Shuttle Buggy)	15.18 **	
Mechanic	17.55	
Milling Machine	15.36 **	
Off-Road Hauler/Water Tanker	11.36 **	
Oiler/Greaser	13.55 **	
Pavement Marking Equipment	12.11 **	
Paver Asphalt	15.59 **	
Paver Concrete	18.20	

	Rates	Fringes
Roller Asphalt Breakdown	12.45 **	
Roller Asphalt Finish	13.85 **	
Roller Other	11.36 **	
Scraper Finish	12.71 **	
Scraper Rough	11.35 **	
Slip Form Machine	16.50	
Tack Truck/Distributor Operator	14.52 **	
TRUCK DRIVER		
GVWR of 26,000 Lbs or Less	11.12 **	
GVWR of 26,001 Lbs or Greater	12.37 **	

Welders – Receive rate prescribed for craft performing operation to which welding is incidental.

** Workers in this classification may be entitled to a higher minimum wage under Executive Order 14026 (\$17.20) or 13658 (\$12.90). Please see the Note at the top of the wage determination for more information. Please also note that the minimum wage requirements of Executive Order 14026 are not currently being enforced as to any contract or subcontract to which the states of Texas, Louisiana, or Mississippi, including their agencies, are a party.

Note: Executive Order (EO) 13706, Establishing Paid Sick Leave for Federal Contractors applies to all contracts subject to the Davis-Bacon Act for which the contract is awarded (and any solicitation was issued) on or after January 1, 2017. If this contract is covered by the EO, the contractor must provide employees with 1 hour of paid sick leave for every 30 hours they work, up to 56 hours of paid sick leave each year. Employees must be permitted to use paid sick leave for their own illness, injury or other health-related needs, including preventive care; to assist a family member (or person who is like family to the employee) who is ill, injured, or has other health-related needs, including preventive care; or for reasons resulting from, or to assist a family member (or person who is like family to the employee) who is a victim of, domestic violence, sexual assault, or stalking. Additional information on contractor requirements and worker protections under the EO is available at <https://www.dol.gov/agencies/whd/government-contracts>.

Unlisted classifications needed for work not included within the scope of the classifications listed may be added after award only as provided in the labor standards contract clauses (29 CFR 5.5(a)(1)(iii)).

The body of each wage determination lists the classification and wage rates that have been found to be prevailing for the cited type(s) of construction in the area covered by the wage determination. The classifications are listed in alphabetical order of "identifiers" that indicate whether the particular rate is a union rate (current union negotiated rate for local), a survey rate (weighted average rate) or a union average rate (weighted union average rate).

Union Rate Identifiers

A four letter classification abbreviation identifier enclosed in dotted lines beginning with characters other than "SU" or "UAVG" denotes that the union classification and rate were prevailing for that classification in the survey. Example: PLUM0198-005 07/01/2014. PLUM is an abbreviation identifier of the union which prevailed in the survey for this classification, which in this example would be Plumbers. 0198 indicates the local union number or district council

number where applicable, i.e., Plumbers Local 0198. The next number, 005 in the example, is an internal number used in processing the wage determination. 07/01/2014 is the effective date of the most current negotiated rate, which in this example is July 1, 2014.

Union prevailing wage rates are updated to reflect all rate changes in the collective bargaining agreement (CBA) governing this classification and rate.

Survey Rate Identifiers

Classifications listed under the "SU" identifier indicate that no one rate prevailed for this classification in the survey and the published rate is derived by computing a weighted average rate based on all the rates reported in the survey for that classification. As this weighted average rate includes all rates reported in the survey, it may include both union and non-union rates. Example: SULA2012-007 5/13/2014. SU indicates the rates are survey rates based on a weighted average calculation of rates and are not majority rates. LA indicates the State of Louisiana. 2012 is the year of survey on which these classifications and rates are based. The next number, 007 in the example, is an internal number used in producing the wage determination. 5/13/2014 indicates the survey completion date for the classifications and rates under that identifier.

Survey wage rates are not updated and remain in effect until a new survey is conducted.

Union Average Rate Identifiers

Classification(s) listed under the UAVG identifier indicate that no single majority rate prevailed for those classifications; however, 100% of the data reported for the classifications was union data. EXAMPLE: UAVG-OH-0010 08/29/2014. UAVG indicates that the rate is a weighted union average rate. OH indicates the state. The next number, 0010 in the example, is an internal number used in producing the wage determination. 08/29/2014 indicates the survey completion date for the classifications and rates under that identifier.

A UAVG rate will be updated once a year, usually in January of each year, to reflect a weighted average of the current negotiated/CBA rate of the union locals from which the rate is based.

WAGE DETERMINATION APPEALS PROCESS

1.) Has there been an initial decision in the matter? This can be:

- * an existing published wage determination
- * a survey underlying a wage determination
- * a Wage and Hour Division letter setting forth a position on a wage determination matter
- * a conformance (additional classification and rate) ruling

On survey related matters, initial contact, including requests for summaries of surveys, should be with the Wage and Hour National Office because National Office has responsibility for the David-Bacon survey program. If the response from this initial contact is not satisfactory, then the process described in 2.) and 3.) should be followed.

With regard to any other matter not yet ripe for the formal process described here, initial contact should be with the Branch of Construction Wage Determinations. Write to:

Branch of Construction Wage Determinations

Wage and Hour Division
U. S. Department of Labor
200 Constitution Avenue, N.W.
Washington, D.C. 20210

- 2.) If the answer to the question in 1.) is yes, then an interested party (those affected by the action) can request review and reconsideration from the Wage and Hour Administrator (See 29 CFR Part 1.8 and 29 CFR Part 7). Write to:

Wage and Hour Administrator
U.S. Department of Labor
200 Constitution Avenue, N.W.
Washington, D.C. 20210

The request should be accompanied by a full statement of the interested party's position and by any information (wage payment data, project description, area practice material, etc.) that the requestor considers relevant to the issue.

- 3.) If the decision of the Administrator is not favorable, an interested party may appeal directly to the Administrative Review Board (formerly the Wage Appeals Board). Write to:

Administrative Review Board
U.S. Department of Labor
200 Constitution Avenue, N.W.
Washington, D.C. 20210

- 4.) All decisions by the Administrative Review Board are final.

END OF GENERAL DECISION

PROJECT SPECIAL PROVISIONS

GEOTECHNICAL

MSE RETAINING WALLS - (01/16/2024)

GT-1.1 - GT-1.12

TEMPORARY SOIL NAIL WALLS - (01/16/2024)

GT-2.1 - GT-2.9

STANDARD SHORING - (01/16/2024)

GT-3.1 - GT-3.4

ARCHITECTURAL CONCRETE SURFACE TREATMENT (SPECIAL)

GT-4.1 - GT-4.5

DocuSigned by:
Geotechnical Engineering Unit
E06538624A11498... 01/24/2024

MECHANICALLY STABILIZED EARTH RETAINING WALLS**(1-16-24)****1.0 GENERAL**

Construct mechanically stabilized earth (MSE) retaining walls consisting of steel or geosynthetic reinforcement in the reinforced zone connected to vertical facing elements. Use precast concrete panels for vertical facing elements and coarse aggregate in the reinforced zone unless noted otherwise in the plans. Provide reinforced concrete coping and pile sleeves as required. Design and construct MSE retaining walls based on actual elevations and wall dimensions in accordance with the contract and accepted submittals. Use a prequalified MSE Wall Installer to construct MSE retaining walls.

Define MSE wall terms as follows:

Geosynthetic Reinforcement – Polyester Type (PET), HDPE or Polypropylene (PP) geosynthetic grids, i.e., geogrid reinforcement or polymer straps, i.e., geostrip reinforcement,

Geogrid – PET, HDPE or PP geogrid,

Reinforcement – Steel or geosynthetic reinforcement,

Aggregate – Coarse or fine aggregate,

Panel – Precast concrete panel,

Coping – Precast or CIP concrete coping,

Design Height (H) – Wall height + wall embedment as shown in the plans,

MSE Wall – Mechanically stabilized earth retaining wall,

MSE Wall Vendor – Vendor supplying the chosen MSE wall system,

MSE Panel Wall – MSE wall with panels,

MSE Segmental Wall – MSE wall with segmental retaining wall (SRW) units and

Abutment Wall – MSE wall with bridge foundations in any portion of the reinforced zone or an MSE wall connected to an abutment wall (even if bridge foundations only penetrate a small part of the reinforced zone, the entire MSE wall is considered an abutment wall).

For bridge approach fills behind end bents with MSE abutment walls, design reinforcement connected to end bent caps in accordance with the plans and this provision.

Use an approved MSE wall system in accordance with the plans and any NCDOT restrictions or exceptions for the chosen system. Value engineering proposals for other MSE wall systems will not be considered. Do not use MSE wall systems with an “approved for provisional use” status for MSE walls with design heights greater than 35 ft or walls supporting or adjacent to railroads or interstate highways. The list of approved MSE wall systems with approval status is available from:

connect.ncdot.gov/resources/Geological/Pages/Products.aspx

2.0 MATERIALS

Refer to the *Standard Specifications*.

Item	Section
Aggregate	1014
Asphalt Concrete Base Course, Type B25.0C	620
Corrugated Steel Pipe	1032-3

Epoxy, Type 3A	1081
Geosynthetics	1056
Grout, Type 3	1003
Joint Materials	1028
Portland Cement Concrete, Class A	1000
Precast Retaining Wall Coping	1077
Reinforcing Steel	1070
Retaining Wall Panels	1077
Segmental Retaining Wall Units	1040-4
Select Material, Class V	1016
Shoulder Drain Materials	816-2
Steel Pipe	1036-4(A)

Use galvanized corrugated steel pipe with a zinc coating weight of 2 oz/sf (G200) for pile sleeves. Provide Type 2 geotextile for filtration and separation geotextiles. Use Class A concrete for CIP coping, leveling concrete and pads. Use galvanized steel pipe, threaded rods and nuts for the PET geogrid reinforcement vertical obstruction detail. Provide galvanized Grade 36 anchor rods and Grade A hex nuts that meet AASHTO M 314 for threaded rods and nuts.

Use panels and SRW units from producers approved by the Department and licensed by the MSE Wall Vendor. Provide steel strip connectors embedded in panels fabricated from structural steel that meets the requirements for steel strip reinforcement. Unless required otherwise in the contract, produce panels with a smooth flat final finish that meets Article 1077-11 of the *Standard Specifications*. Accurately locate and secure reinforcement connectors in panels and maintain required concrete cover. Produce panels within 1/4" of the panel dimensions shown in the accepted submittals.

Damaged panels or SRW units with excessive discoloration, chips or cracks as determined by the Engineer will be rejected. Do not damage reinforcement connection devices or mechanisms in handling or storing panels and SRW units.

Store steel materials on blocking at least 12" above the ground and protect it at all times from damage; and when placing in the work make sure it is free from dirt, dust, loose mill scale, loose rust, paint, oil or other foreign materials. Handle and store geosynthetics in accordance with Article 1056-2 of the *Standard Specifications*. Load, transport, unload and store MSE wall materials so materials are kept clean and free of damage. Bent, damaged or defective materials will be rejected.

A. Aggregate

Use standard size No. 57, 57M, 67 or 78M that meets Table 1005-1 of the *Standard Specifications* for coarse aggregate and the following for fine aggregate:

1. Standard size No. 1S, 2S, 2MS or 4S that meets Table 1005-2 of the *Standard Specifications* or
2. Gradation that meets Class III, Type 3 select material in accordance with Article

1016-3 of the *Standard Specifications*.

Fine aggregate is exempt from mortar strength in Subarticle 1014-1(E) of the *Standard Specifications*. Use fine aggregate with a maximum organic content of 1.0%. Provide aggregate with chemical properties that meet the following requirements:

AGGREGATE pH REQUIREMENTS		
Aggregate Type (in reinforced zone)	Reinforcement or Connector Material	pH
Coarse or Fine	Steel	5 – 10
Coarse or Fine	Geosynthetic	4.5 – 9

AGGREGATE ELECTROCHEMICAL REQUIREMENTS (Steel Reinforcement/Connector Materials Only)			
Aggregate Type (in reinforced zone)	Resistivity	Chlorides	Sulfates
Coarse	$\geq 5,000 \Omega \cdot \text{cm}$	$\leq 100 \text{ ppm}$	$\leq 200 \text{ ppm}$
Fine	$\geq 3,000 \Omega \cdot \text{cm}$		

Use aggregate from sources participating in the Department's Aggregate QC/QA Program as described in Section 1006 of the *Standard Specifications*. Sample and test aggregate in accordance with the *Mechanically Stabilized Earth Wall Aggregate Sampling and Testing Procedures*.

B. Reinforcement

Provide steel or geosynthetic reinforcement supplied by the MSE Wall Vendor or a manufacturer approved or licensed by the vendor. Use reinforcement approved for the chosen MSE wall system. The list of approved reinforcement for each MSE wall system is available from the website shown elsewhere in this provision.

1. Steel Reinforcement

Provide Type 1 material certifications in accordance with Article 106-3 of the *Standard Specifications* for steel reinforcement. Use welded wire grid reinforcement ("mesh", "mats" and "ladders") that meet Article 1070-3 of the *Standard Specifications* and steel strip reinforcement ("straps") that meet ASTM A572, A1011 or A463. Use 10 gauge or heavier structural steel Grade 50 or higher for steel strip reinforcement. Galvanize steel reinforcement in accordance with Section 1076 of the *Standard Specifications* or provide aluminized steel strip reinforcement that meet ASTM A463, Type 2-100.

2. Geosynthetic Reinforcement

Provide Type 1 material certifications and identify geosynthetic reinforcement in accordance with Article 1056-3 of the *Standard Specifications*. Define machine

direction (MD) and cross-machine direction (CD) for geogrids per Article 1056-3 of the *Standard Specifications*.

Use HDPE or PP geogrid for geogrid reinforcement cast into backwalls of end bent caps. Use PET or HDPE geogrid for geogrid reinforcement connected directly to SRW units and only HDPE geogrid for geogrid reinforcement cast into panels.

Provide extruded geogrids produced in the United States and manufactured from punched and drawn polypropylene sheets for PP geogrids that meet the following:

PP GEOGRID REQUIREMENTS		
Property	Requirement¹	Test Method
Aperture Dimensions ²	1" x 1.2"	N/A
Minimum Rib Thickness ²	0.07" x 0.07"	N/A
Tensile Strength @ 2% Strain ²	580 lb/ft x 690 lb/ft	ASTM D6637, Method B
Tensile Strength @ 5% Strain ²	1,200 lb/ft x 1,370 lb/ft	
Ultimate Tensile Strength ²	1,850 lb/ft x 2,050 lb/ft	
Junction Efficiency ³ (MD)	93%	ASTM D7737
Flexural Rigidity ⁴	2,000,000 mg-cm	ASTM D7748
Aperture Stability Modulus ⁵	0.55 lb-ft/degrees	ASTM D7864
UV Stability (Retained Strength)	100% (after 500 hr of exposure)	ASTM D4355

- MARV per Article 1056-3 of the *Standard Specifications* except dimensions and thickness are nominal.
- Requirement for MD x CD.
- Junction Efficiency (%) = (Average Junction Strength (X_{jave}) / Ultimate Tensile Strength in the MD from ASTM D6637, Method A) \times 100.
- Test specimens two ribs wide, with transverse ribs cut flush with exterior edges of longitudinal ribs, and sufficiently long to enable measurement of the overhang dimension.
- Applied moment of 17.7 lb-inch (torque increment).

C. Bearing Pads

For MSE panel walls, use preformed ethylene propylene diene monomer rubber bearing pads that meet ASTM D2000 Grade 2, Type A, Class A with a durometer hardness of 60 or 80 ± 5 . Provide bearing pads with thicknesses that meet the following:

BEARING PAD THICKNESS	
Facing Area per Panel (A)	Minimum Pad Thickness After Compression (based on 2 times panel weight above pads)
$A \leq 30$ sf	1/2"
$30 \text{ sf} < A \leq 75$ sf	3/4"

D. Miscellaneous Components

Miscellaneous components may include connectors (e.g., anchors, bars, clamps, pins,

plates, ties, etc.), fasteners (e.g., bolts, nuts, washers, etc.) and any other MSE wall components not included above. Use 10 gauge or heavier structural steel Grade 50 or higher for steel strip panel anchors and connectors. Galvanize steel components in accordance with Section 1076 of the *Standard Specifications*. Provide miscellaneous components approved for the chosen MSE wall system. The list of approved miscellaneous components for each MSE wall system is available from the website shown elsewhere in this provision.

3.0 PRECONSTRUCTION REQUIREMENTS

A. MSE Wall Surveys

The Retaining Wall Plans show a plan view, typical sections, details, notes and an elevation or profile view (wall envelope) for each MSE wall. Before beginning MSE wall design, survey existing ground elevations shown in the plans and other elevations in the vicinity of MSE wall locations as needed. For proposed slopes above or below MSE walls, survey existing ground elevations to at least 10 ft beyond slope stake points. Based on these elevations, finished grades and actual MSE wall dimensions and details, submit revised wall envelopes for acceptance. Use accepted wall envelopes for design.

B. MSE Wall Designs

For MSE wall designs, submit PDF files of working drawings and design calculations at least 30 days before the preconstruction meeting. Note name and NCDOT ID number of the panel or SRW unit production facility on working drawings. Do not begin MSE wall construction until a design submittal is accepted.

Use a prequalified MSE Segmental Wall Design Consultant to design MSE segmental walls. Provide MSE segmental wall designs sealed by a Design Engineer approved as a Geotechnical Engineer (key person) for the MSE Segmental Wall Design Consultant. Provide MSE panel wall designs sealed by a Design Engineer licensed in the state of North Carolina and employed or contracted by the MSE Wall Vendor.

Design MSE walls in accordance with the plans, *AASHTO LRFD Bridge Design Specifications* and any NCDOT restrictions for the chosen MSE wall system unless otherwise required. For abutment walls only, design MSE walls for seismic if wall sites meet either or both of the following:

- Wall site is in seismic zone 2 based on Figure 2-1 of the *Structure Design Manual*,
- Wall site is classified as AASHTO Site Class E, as noted in the plans, and is in or west of Pender, Duplin, Wayne, Johnston, Wake, Durham or Person County.

Connect reinforcement to panels or SRW units with methods or devices approved for the chosen system. Use a uniform reinforcement length throughout the height of the wall of at least $0.7H$ or 6 ft, whichever is longer, unless noted otherwise in the plans. Extend the reinforced zone at least 6" beyond end of reinforcement. Do not locate drains, the reinforced zone or leveling pads outside right-of-way or easement limits.

Use the simplified method for determining maximum reinforcement loads and design parameters approved for the chosen MSE wall system or default values in accordance with the AASHTO LRFD specifications. Design steel components including reinforcement and connectors for the design life noted in the plans and aggregate type in the reinforced zone. If an MSE wall system with geosynthetic reinforcement includes any steel parts for obstructions, bin walls, connections or other components, design steel exposed to aggregate for the design life noted in the plans and aggregate type in the reinforced zone. Use “loss of galvanizing” metal loss rates for nonaggressive backfill in accordance with the AASHTO LRFD specifications for galvanized and aluminized steel and metal loss rates for carbon steel in accordance with the following:

CARBON STEEL CORROSION RATES	
Aggregate Type (in reinforced zone)	Carbon Steel Loss Rate (after coating depletion)
Coarse	0.47 mil/year
Fine (except abutment walls)	0.58 mil/year
Fine (abutment walls)	0.70 mil/year

For PET or HDPE geogrid and geostrip reinforcement and geosynthetic connectors, use approved geosynthetic properties for the design life noted in the plans and aggregate type in the reinforced zone. For geogrid reinforcement connected to end bent caps, embed reinforcement or connectors in caps as shown in the plans. For PP geogrid reinforcement connected to end bent caps, use the following design parameters for the aggregate type in the reinforced approach fill.

PP GEOGRID REINFORCEMENT DESIGN PARAMETERS				
Aggregate Type (in reinforced zone)	T_{al} (MD)	F*	α	ρ
Coarse	400 lb/ft	0.70	0.8	32.0°
Fine	428 lb/ft	0.54	0.8	28.35°

Where,

- T_{al} = long-term design strength (LTDS),
 F* = pullout resistance factor,
 α = scale effect correction factor and
 ρ = soil-geogrid friction angle.

When noted in the plans, design MSE walls for a live load (traffic) surcharge of 250 psf in accordance with Figure C11.5.6-3(b) of the AASHTO LRFD specifications. For steel beam guardrail with 8 ft posts or concrete barrier rail above MSE walls, analyze top 2 reinforcement layers for traffic impact loads in accordance with Section 7.2 of *FHWA Design and Construction of Mechanically Stabilized Earth Walls and Reinforced Soil Slopes – Volume I* (Publication No. FHWA-NHI-10-024) except use the following for geosynthetic reinforcement rupture:

$$\phi T_{al} R_c \geq T_{max} + (T_I / R_{FCR})$$

Where,

- ϕ = resistance factor for tensile resistance in accordance with Section 7.2.1 of the FHWA MSE wall manual,
- T_{al} = long-term geosynthetic design strength approved for chosen MSE wall system,
- R_c = reinforcement coverage ratio = 1 for continuous geosynthetic reinforcement,
- T_{max} = factored static load in accordance with Section 7.2 of the FHWA MSE wall manual,
- T_I = factored impact load in accordance with Section 7.2 of the FHWA MSE wall manual and
- RF_{CR} = creep reduction factor approved for chosen MSE wall system.

When shown in the plans for abutment walls, use pile sleeves to segregate piles from aggregate in the reinforced zone. If existing or future obstructions such as foundations, guardrail, fence or handrail posts, moment slabs, pavements, pipes, inlets or utilities will interfere with reinforcement, maintain a clearance of at least 3" between obstructions and reinforcement unless otherwise approved. Design reinforcement for obstructions and locate reinforcement layers so all of reinforcement length is within 3" of corresponding connection elevations. Modify PET geogrid reinforcement for obstructions as shown in the plans.

Use 6" thick CIP unreinforced concrete leveling pads beneath panels and SRW units that are continuous at steps and extend at least 6" in front of and behind bottom row of panels or SRW units. Unless required otherwise in the plans, embed top of leveling pads in accordance with the following requirements:

WALL EMBEDMENT REQUIREMENTS		
Front Slope¹ (H:V)	Minimum Embedment Depth² (whichever is greater)	
6:1 or flatter (except abutment walls)	H/20	1 ft for H ≤ 10 ft 2 ft for H > 10 ft
6:1 or flatter (abutment walls)	H/10	2 ft
> 6:1 to < 3:1	H/10	2 ft
3:1 to 2:1	H/7	2 ft

1. Front slope is as shown in the plans.
2. H is the maximum design height per wall.

When noted in the plans, locate a continuous aggregate shoulder drain along the base of the reinforced zone behind the aggregate. Provide wall drainage systems consisting of drains and outlet components in accordance with Roadway Standard Drawing No. 816.02.

For MSE panel walls, cover joints at back of panels with filtration geotextiles at least 12" wide. If the approval of the chosen MSE wall system does not require a minimum number of bearing pads, provide the number of pads in accordance with the following:

NUMBER OF BEARING PADS

Facing Area per Panel (A)	Maximum Height of Wall Above Horizontal Panel Joint	Minimum Number of Pads per Horizontal Panel Joint
$A \leq 30$ sf	25 ft	2
	35 ft ¹	3
$30 \text{ sf} < A \leq 75$ sf	25 ft	3
	35 ft ¹	4

1. Additional bearing pads per horizontal panel joint may be required for wall heights above joints greater than 35 ft.

For MSE segmental walls, coarse aggregate is required in any SRW unit core spaces and between and behind SRW units for a horizontal distance of at least 18".

Separation geotextiles are required between the aggregate and overlying fill sections. When noted in the plans, separation geotextiles are also required at the back of the reinforced zone between the aggregate and backfill or natural ground. When placing pavement sections directly on the reinforced zone, cap aggregate with 4" of asphalt concrete base course. Unless required otherwise in the plans, use reinforced concrete coping at top of walls that meets the following requirements:

1. Coping dimensions as shown in the plans,
2. At the Contractor's option, coping that is precast or CIP concrete for MSE panel walls unless CIP coping is required as shown in the plans,
3. CIP concrete coping for MSE segmental walls and
4. At the Contractor's option and when shown in the plans, CIP concrete coping that extends down back of panels or SRW units or connects to panels or SRW units with dowels.

For MSE segmental walls with dowels, attach dowels to top courses of SRW units in accordance with the following:

1. Set dowels in core spaces of SRW units filled with grout instead of coarse aggregate or
2. Embed adhesively anchored dowels in holes of solid SRW units with epoxy.

For MSE panel walls with coping, connect CIP concrete coping or leveling concrete for precast concrete coping to top row of panels with dowels cast into panels. When concrete barrier rail is required above MSE walls, use concrete barrier rail with moment slab as shown in the plans.

Submit working drawings and design calculations for acceptance in accordance with Article 105-2 of the *Standard Specifications*. Submit working drawings showing plan views, wall profiles with foundation pressures, typical sections with reinforcement and connection details, aggregate locations and types, geotextile locations and details of leveling pads, panels or SRW units, coping, bin walls, slip joints, pile sleeves, etc. If

necessary, include details on working drawings for concrete barrier rail with moment slab, reinforcement splices if allowed for the chosen MSE wall system, reinforcement connected to end bent caps, curved MSE walls with tight (short) radii and obstructions extending through walls or interfering with reinforcement, leveling pads, barriers or moment slabs. Submit design calculations for each wall section with different surcharge loads, geometry or material parameters. At least one analysis is required for each wall section with different reinforcement lengths. When designing MSE walls with computer software other than MSEW, use MSEW manufactured by ADAMA Engineering, Inc. to verify the design. At least one MSEW analysis is required per 100 ft of wall length with at least one analysis for the wall section with the longest reinforcement. Submit electronic MSEW input files and PDF output files with design calculations.

C. Preconstruction Meeting

Before starting MSE wall construction, hold a preconstruction meeting to discuss the construction and inspection of the MSE walls. If this meeting occurs before all MSE wall submittals have been accepted, additional preconstruction meetings may be required before beginning construction of MSE walls without accepted submittals. The Resident or Bridge Maintenance Engineer, Area Construction Engineer, Geotechnical Operations Engineer, Contractor and MSE Wall Installer Superintendent will attend preconstruction meetings.

4.0 CORROSION MONITORING

Corrosion monitoring is required for MSE walls with steel reinforcement. The Engineer will determine the number of monitoring locations and where to install the instrumentation. Contact M&T before beginning wall construction. M&T will provide the corrosion monitoring instrumentation kits and if necessary, assistance with installation.

5.0 SITE ASSISTANCE

Unless otherwise approved, an MSE Wall Vendor representative is required to assist and guide the MSE Wall Installer on-site for at least 8 hours when the first panels or SRW units and reinforcement layer are placed. If problems are encountered during construction, the Engineer may require the vendor representative to return to the site for a time period determined by the Engineer.

6.0 CONSTRUCTION METHODS

Control drainage during construction in the vicinity of MSE walls. Direct run off away from MSE walls, aggregate and backfill. Contain and maintain aggregate and backfill and protect material from erosion.

Excavate as necessary for MSE walls in accordance with the accepted submittals. If applicable and at the Contractor's option, use temporary shoring for wall construction instead of temporary slopes to construct MSE walls. Define "temporary shoring for wall construction" as temporary shoring not shown in the plans or required by the Engineer including shoring for OSHA reasons or the Contractor's convenience.

Unless required otherwise in the plans, install foundations and if required, pile sleeves located in the reinforced zone before placing aggregate or reinforcement. Brace piles in the reinforced zone to maintain alignment when placing and compacting aggregate. Secure piles together with steel members near top of piles. Clamp members to piles instead of welding if bracing is at or below pile cut-off elevations.

Notify the Engineer when foundation excavation is complete. Do not place leveling pad concrete, aggregate or reinforcement until excavation dimensions and foundation material are approved.

Construct CIP concrete leveling pads at elevations and with dimensions shown in the accepted submittals and in accordance with Section 420 of the *Standard Specifications*. Cure leveling pads at least 24 hours before placing panels or SRW units.

Erect and support panels and stack SRW units so the final wall position is as shown in the accepted submittals. Stagger SRW units to create a running bond by centering SRW units over joints in the row below as shown in the accepted submittals. Space bearing pads in horizontal panel joints as shown in the accepted submittals and cover all panel joints with filtration geotextiles as shown in the accepted submittals. Attach filtration geotextiles to back of panels with adhesives, tapes or other approved methods.

Construct MSE walls with the following tolerances:

- A. SRW units are level from front to back and between units when checked with a 4 ft long level,
- B. Vertical joint widths are 1/4" maximum for SRW units and 3/4", $\pm 1/4$ " for panels,
- C. Final wall face is within 3/4" of horizontal and vertical alignment shown in the accepted submittals when measured along a 10 ft straightedge and
- D. Final wall plumbness (batter) is not negative (wall face leaning forward) and within 0.5° of vertical unless otherwise approved.

Place reinforcement at locations and elevations shown in the accepted submittals and within 3" of corresponding connection elevations. Install reinforcement with the direction shown in the accepted submittals. Before placing aggregate, pull geosynthetic reinforcement taut so it is in tension and free of kinks, folds, wrinkles or creases. Reinforcement may be spliced once per reinforcement length if shown in the accepted submittals. Use reinforcement pieces at least 6 ft long. Contact the Engineer when unanticipated existing or future obstructions such as foundations, guardrail, fence or handrail posts, pavements, pipes, inlets or utilities will interfere with reinforcement. To avoid obstructions, deflect, skew or modify reinforcement as shown in the accepted submittals.

Place aggregate in the reinforced zone in 8" to 10" thick lifts. Compact fine aggregate in accordance with Subarticle 235-3(C) of the *Standard Specifications*. Use only hand operated compaction equipment to compact aggregate within 3 ft of panels or SRW units. At a distance greater than 3 ft, compact aggregate with at least 4 passes of an 8 ton to 10 ton vibratory roller in a direction parallel to the wall face. Smooth wheeled or rubber tired rollers are also acceptable for compacting aggregate. Do not use sheepsfoot, grid rollers or other

types of compaction equipment with feet. Do not displace or damage reinforcement when placing and compacting aggregate. End dumping directly on geosynthetics is not permitted. Do not operate heavy equipment on reinforcement until it is covered with at least 8" of aggregate. Replace any damaged reinforcement to the satisfaction of the Engineer.

Backfill for MSE walls outside the reinforced zone in accordance with Article 410-8 of the *Standard Specifications*. If a drain is required, install wall drainage systems as shown in the accepted submittals and in accordance with Section 816 of the *Standard Specifications*. If pile sleeves are required, fill sleeves with loose uncompacted sand before constructing end bent caps.

Install dowels as necessary for SRW units and place and construct coping and leveling concrete as shown in the accepted submittals. Construct leveling concrete in accordance with Section 420 of the *Standard Specifications*. Construct CIP concrete coping in accordance with Subarticle 452-4(B) of the *Standard Specifications*. When single faced precast concrete barrier is required in front of and against MSE walls, stop coping just above barrier so coping does not interfere with placing barrier up against wall faces. If the gap between a single faced barrier and wall face is wider than 2", fill gap with Class V select material (standard size No. 78M stone). Otherwise, fill gap with backer rod and seal joint between barrier and MSE wall with silicone sealant.

When separation geotextiles are required, overlap adjacent geotextiles at least 18" and hold geotextiles in place with wire staples or anchor pins as needed. Seal joints above and behind MSE walls between coping and concrete slope protection with silicone sealant.

7.0 MEASUREMENT AND PAYMENT

MSE Retaining Wall No. ___ will be measured and paid in square feet. MSE walls will be measured as the square feet of wall face area with the pay height equal to the difference between top of wall and top of leveling pad elevations. Define "top of wall" as top of coping or top of panels or SRW units for MSE walls without coping.

The contract unit price for *MSE Retaining Wall No. ___* will be full compensation for providing designs, submittals, labor, tools, equipment and MSE wall materials, excavating, hauling and removing excavated materials, placing and compacting aggregate and backfill material and supplying site assistance, leveling pads, panels, SRW units, reinforcement, aggregate, wall drainage systems, geotextiles, aggregate concrete base course, bearing pads, coping, miscellaneous components and any incidentals necessary to construct MSE walls. The contract unit price for *MSE Retaining Wall No. ___* will also be full compensation for reinforcement and connector design for reinforcement connected to end bent caps, wall modifications for obstructions, pile sleeves filled with sand, joints sealed with silicone sealant and gaps between barriers and MSE walls filled with backer rod or No. 78M stone, if required.

No separate payment will be made for temporary shoring for wall construction. Temporary shoring for wall construction will be incidental to the contract unit price for *MSE Retaining Wall No. ___*.

The contract unit price for *MSE Retaining Wall No.* ___ does not include the cost for ditches, fences, handrails, barrier or guardrail associated with MSE walls as these items will be paid for elsewhere in the contract. The contract unit price for *MSE Retaining Wall No.* ___ also does not include the cost for constructing bridge approach fills behind end bents with MSE abutment walls. See *Bridge Approach Fills* provision for measurement and payment of Type 2 Bridge Approach Fills.

Where it is necessary to provide backfill material behind the reinforced zone from sources other than excavated areas or borrow sources used in connection with other work in the contract, payment for furnishing and hauling such backfill material will be paid as extra work in accordance with Article 104-7 of the *Standard Specifications*. Placing and compacting such backfill material is not considered extra work but is incidental to the work being performed.

Payment will be made under:

Pay Item

MSE Retaining Wall No. ___

Pay Unit

Square Foot



DocuSigned by:
Scott A. Hidden
F760CAEB96FC4D3...
01/24/2024

TEMPORARY SOIL NAIL WALLS:**(1-16-24)****Description**

Construct temporary soil nail walls consisting of soil nails spaced at a regular pattern and connected to a reinforced shotcrete face. A soil nail consists of a solid or hollow steel bar grouted in a drilled hole inclined at an angle below horizontal. At the Contractor's option, use temporary soil nail walls instead of temporary shoring for full cut sections. Design and construct temporary soil nail walls based on actual elevations and wall dimensions in accordance with the contract and accepted submittals. Use a prequalified Anchored Wall Contractor to construct temporary soil nail walls. Define "soil nail wall" as a temporary soil nail wall and "Soil Nail Wall Contractor" as the Anchored Wall Contractor installing soil nails and applying shotcrete. Define "nail" as a soil nail.

Provide positive protection for soil nail walls at locations shown in the plans and as directed. See *Temporary Shoring* provision for positive protection types and definitions.

Materials

Refer to Division 10 of the *Standard Specifications*.

Item	Section
Geocomposites	1056
Portland Cement	1024-1
Reinforcing Steel	1070
Shotcrete	1002
Select Material, Class IV	1016
Steel Plates	1072-2
Water	1024-4

Use Type 5 grout for soil nails.

Use Class IV select material for temporary guardrail. Provide soil nails consisting of grouted steel bars and nail head assemblies. Use deformed solid steel bars that meet AASHTO M 275 or M 31, Grade 60, 75 or 80. Splice solid bars in accordance with Article 1070-9 of the *Standard Specifications*. Use hollow steel bars manufactured by DYWIDAG-Systems International USA Inc., Nucor Skyline, Williams Form Engineering Corp. or an approved equal.

Use centralizers that meet Article 34.3.4 of the *AASHTO LRFD Bridge Construction Specifications*. Provide nail head assemblies consisting of nuts, washers and bearing plates. Use steel plates for bearing plates and steel washers and hex nuts recommended by the Soil Nail Manufacturer.

Provide Type 6 material certifications for soil nail materials in accordance with Article 106-3 of the *Standard Specifications*. Store steel materials on blocking at least 12" above the ground and protect it at all times from damage; and when placing in the work make sure it is free from dirt, dust, loose mill scale, loose rust, paint, oil or other foreign materials. Load, transport, unload and store soil nail wall materials so materials are kept clean and free of damage. Bent, damaged or defective materials will be rejected.

Preconstruction Requirements

(A) Concrete Barrier

Define “clear distance” behind concrete barrier as the horizontal distance between the barrier and edge of pavement. The minimum required clear distance for concrete barrier is shown in the plans. At the Contractor’s option or if the minimum required clear distance is not available, set concrete barrier next to and up against traffic side of soil nail walls except for barrier above walls. Concrete barrier with the minimum required clear distance is required above soil nail walls.

(B) Temporary Guardrail

Define “clear distance” behind temporary guardrail as the horizontal distance between guardrail posts and soil nail walls. At the Contractor’s option or if clear distance for soil nail walls is less than 4 ft, use temporary guardrail with 8 ft posts and a clear distance of at least 2.5 ft. Place ABC in clear distance and around guardrail posts instead of pavement.

(C) Soil Nail Wall Designs

Before beginning soil nail wall design, survey existing ground elevations in the vicinity of wall locations to determine actual design heights (H). Use a prequalified Anchored Wall Design Consultant to design soil nail walls. Provide designs sealed by a Design Engineer approved as a Geotechnical Engineer (key person) for the Anchored Wall Design Consultant.

Design soil nail walls in accordance with the plans and the *AASHTO LRFD Bridge Design Specifications* unless otherwise required. Design soil nails that meet the following unless otherwise approved:

- (1) Horizontal and vertical spacing of at least 3 ft,
- (2) Inclination of at least 12° below horizontal and
- (3) Diameter of 4" to 10".

Do not extend nails beyond right-of-way or easement limits. If existing or future obstructions such as foundations, pavements, pipes, inlets or utilities will interfere with nails, maintain a clearance of at least 6" between obstructions and nails.

Design soil nail walls for a traffic surcharge of 250 psf if traffic will be above and within H of walls. This traffic surcharge does not apply to construction traffic. Design soil nail walls for any construction surcharge if construction traffic will be above and within H of walls. For temporary guardrail with 8 ft posts above soil nail walls, analyze shotcrete and top row of nails for a nominal horizontal load of 300 lb/ft of wall with a load factor of 1.0.

Place geocomposite sheet drains with a horizontal spacing of no more than 10 ft and center drains between adjacent nails. Attach sheet drains to excavation faces. Design shotcrete in accordance with Article 11.12.6.2 of the *AASHTO LRFD Bridge Design Specifications*.

Submit PDF files of working drawings and design calculations for soil nail wall designs in accordance with Article 105-2 of the *Standard Specifications*. Submit working drawings showing plan views, wall profiles, typical sections and details of soil nail wall design and construction sequence. Include details in working drawings of soil nail locations, unit grout/ground bond strengths, shotcrete reinforcement and if necessary, obstructions extending through walls or interfering with nails. Include details in construction sequence

of excavation, grouting, installing reinforcement, nail testing and shotcreting with mix designs and shotcrete nozzleman certifications. Do not begin soil nail wall construction until a design submittal is accepted.

Submit design calculations for each wall section with different surcharge loads, geometry or material parameters. Include analysis of temporary conditions during construction in design calculations. At least one analysis is required for each wall section with different nail lengths. Analyze internal and compound stability with a computer software program that uses limit equilibrium methods and submit all PDF output files from the program with the design calculations. See Article C11.12.2 of the AASHTO LRFD specifications for determining the maximum soil nail force, $T_{\max sn}$. Once $T_{\max sn}$ and pullout length behind slip surface, L_P , are determined from limit equilibrium methods at the target soil failure resistance factor (1 over factor of safety output from computer software), use these values for soil nail (pullout and tensile resistance) and wall facing (flexure, punching shear and headed-stud tensile resistance) design in accordance with Articles 11.12.5.2, 11.12.6.1 and 11.12.6.2 of the AASHTO LRFD specifications.

- (1) When designing soil nail walls with computer software Snail manufactured by the California Department of Transportation (CALTRANS), use Snail version 2.2.0 or later, to calculate factors of safety and $T_{\max sn}$ and L_P values in accordance with the following: Allowable Stress Design for Analysis Method with no load factors applied except those applied to factored surcharge loads from structures or traffic,
- (2) Perform Below Toe Search option selected when any soil layer has a friction angle less than 30° and
- (3) Default value of 0.33 for Interface Friction Reduction Factor.

When designing soil nail walls with computer software other than Snail, use bi-linear (or tri-linear, as applicable) search surfaces intended to reproduce Snail results. Factors of safety and $T_{\max sn}$ and L_P values are acceptable if they are within 5% of the factors of safety and $T_{\max sn}$ and L_P values calculated by the Engineer using the computer software Slide2 manufactured by Rocscience, Inc.

(D) Preconstruction Meeting

Before starting soil nail wall construction, hold a preconstruction meeting to discuss the construction, inspection and testing of the soil nail walls. If this meeting occurs before all soil nail wall submittals have been accepted, additional preconstruction meetings may be required before beginning construction of soil nail walls without accepted submittals. The Resident, District or Bridge Maintenance Engineer, Area Construction Engineer, Geotechnical Operations Engineer, Contractor and Soil Nail Wall Contractor Superintendent will attend preconstruction meetings.

Construction Methods

Control drainage during construction in the vicinity of soil nail walls. Direct run off away from soil nail walls and areas above and behind walls.

Install foundations located behind soil nail walls before beginning wall construction. Do not excavate behind soil nail walls. If overexcavation occurs, repair walls with an approved method

and a revised soil nail wall design may be required.

Install positive protection in accordance with the contract and accepted submittals. Use PCB in accordance with Section 1170 of the *Standard Specifications* and Roadway Standard Drawing No. 1170.01. Use temporary guardrail in accordance with Section 862 of the *Standard Specifications* and Roadway Standard Drawing No. 862.01, 862.02 and 862.03.

(A) Excavation

Excavate for soil nail walls from the top down in accordance with the accepted submittals. Excavate in staged horizontal lifts with no negative batter (excavation face leaning forward). Excavate lifts in accordance with the following:

- (1) Heights not to exceed vertical nail spacing,
- (2) Bottom of lifts no more than 3 ft below nail locations for current lift and
- (3) Horizontal and vertical alignment within 6" of location shown in the accepted submittals.

Remove any cobbles, boulders, rubble or debris that will protrude more than 2" into the required shotcrete thickness. Rocky ground such as colluvium, boulder fills and weathered rock may be difficult to excavate without leaving voids.

Apply shotcrete to excavation faces within 24 hours of excavating each lift unless otherwise approved. Shotcreting may be delayed if it can be demonstrated that delays will not adversely affect excavation stability. If excavation faces will be exposed for more than 24 hours, use polyethylene sheets anchored at top and bottom of lifts to protect excavation faces from changes in moisture content.

If an excavation becomes unstable at any time, suspend soil nail wall construction and temporarily stabilize the excavation by immediately placing an earth berm up against the unstable excavation face. When this occurs, repair walls with an approved method and a revised soil nail wall design may be required.

Do not excavate the next lift until nail installations and testing and shotcrete application for the current lift are accepted and grout and shotcrete for the current lift have cured at least 3 days and 1 day, respectively.

(B) Soil Nails

Drill and grout nails the same day and do not leave drill holes open overnight. Control drilling and grouting to prevent excessive ground movements, damaging structures and pavements or fracturing rock and soil formations. If ground heave or subsidence occurs, suspend soil nail wall construction and take corrective action to minimize movement. If property damage occurs, make repairs with an approved method and a revised soil nail wall design may be required.

The drilling, steel bar and grouting requirements below are for solid bar nails and may not apply to hollow bar nails. Hollow bar nails are typically installed by simultaneously drilling and grouting as a sacrificial drill bit is advanced and grout is pumped through the bar. For hollow bar nails, submit drilling and grouting procedures for approval before installing soil nails.

(1) Drilling

Use drill rigs of the sizes necessary to install soil nails and with sufficient capacity to drill through whatever materials are encountered. Drill straight and clean holes with the dimensions and inclination shown in the accepted submittals. Drill holes within 6" of locations and 2° of inclination shown in the accepted submittals unless otherwise approved.

Stabilize drill holes with temporary casings if unstable, caving or sloughing material is anticipated or encountered. Do not use drilling fluids to stabilize drill holes or remove cuttings.

(2) Steel Bars

Center solid steel bars in drill holes with centralizers. Securely attach centralizers along bars at no more than 8 ft centers. Attach uppermost and lowermost centralizers 18" from excavation faces and ends of holes.

Do not insert solid steel bars into drill holes until hole locations, dimensions, inclination and cleanliness are approved. Do not vibrate, drive or otherwise force bars into holes. If a steel bar cannot be completely and easily inserted into a drill hole, remove the bar and clean or redrill the hole.

(3) Grouting

Mix and place grout in accordance with Subarticles 1003-5, 1003-6 and 1003-7 of the *Standard Specifications*. Remove oil, rust inhibitors, residual drilling fluids and similar foreign materials from holding tanks/hoppers, stirring devices, pumps, lines, tremie pipes and any other equipment in contact with grout before use. Measure grout temperature, density and flow during grouting with at least the same frequency grout cubes are made for compressive strength. Perform density and flow field tests in the presence of the Engineer in accordance with American National Standards Institute/American Petroleum Institute Recommended Practice 13B-1 (Section 4, Mud Balance) and ASTM C939 (Flow Cone), respectively.

Inject grout at the lowest point of drill holes through tremies, e.g., grout tubes, casings, hollow-stem augers or drill rods, in one continuous operation. Fill drill holes progressively from ends of holes to excavation faces and withdraw tremies at a slow even rate as holes are filled to prevent voids in grout. Extend tremies into grout at least 5 ft at all times except when grout is initially placed in holes.

Provide grout free of segregation, intrusions, contamination, structural damage or inadequate consolidation (honeycombing). Cold joints in grout are not allowed except for test nails. Remove any temporary casings as grout is placed and record grout volume for each drill hole.

(4) Nail Heads

Install nail head assemblies after shotcreting. Before shotcrete reaches initial set, seat bearing plates and tighten nuts so plates contact shotcrete uniformly. If uniform contact is not possible, install nail head assemblies on mortar pads so nail

heads are evenly loaded.

(C) Sheet Drains

Install geocomposite sheet drains as shown in the accepted submittals. Before installing shotcrete reinforcement, place sheet drains with the geotextile side against excavation faces. For highly irregular faces and at the discretion of the Engineer, sheet drains may be placed after shotcreting over weep holes through the shotcrete. Hold sheet drains in place with anchor pins so drains are in continuous contact with surfaces to which they are attached and allow for full flow the entire height of soil nail walls. Discontinuous sheet drains are not allowed. If splices are needed, overlap sheet drains at least 12" so flow is not impeded. Cut off excess sheet drain length and expose drain ends below shotcrete when soil nail wall construction is complete.

(D) Shotcrete

Clean ungrouted zones of drill holes and excavation faces of loose materials, mud, rebound and other foreign material. Moisten surfaces to receive shotcrete. Install shotcrete reinforcement in accordance with the contract and accepted submittals. Secure reinforcing steel so shooting does not displace or vibrate reinforcement. Install approved thickness gauges on 5 ft centers in the horizontal and vertical directions to measure shotcrete thickness.

Apply shotcrete in accordance with the contract, accepted submittals and Subarticle 1002-3(F) of the *Standard Specifications*. Use approved shotcrete nozzlemen who made satisfactory preconstruction test panels to apply shotcrete. Direct shotcrete at right angles to excavation faces except when shooting around reinforcing steel. Rotate nozzle steadily in small circular patterns and apply shotcrete from bottom of lifts up.

Make shotcrete surfaces uniform and free of sloughing or sagging. Completely fill ungrouted zones of drill holes and any other voids with shotcrete. Taper construction joints to a thin edge over a horizontal distance of at least the shotcrete thickness. Wet joint surfaces before shooting adjacent sections.

Repair surface defects as soon as possible after shooting. Remove any shotcrete which lacks uniformity, exhibits segregation, honeycombing or lamination or contains any voids or sand pockets and replace with fresh shotcrete to the satisfaction of the Engineer. Protect shotcrete from freezing and rain until shotcrete reaches initial set.

(E) Construction Records

Provide 2 copies of soil nail wall construction records within 24 hours of completing each lift. Include the following in construction records:

- (1) Names of Soil Nail Wall Contractor, Superintendent, Nozzleman, Drill Rig Operator, Project Manager and Design Engineer;
- (2) Wall description, county, Department's contract, TIP and WBS element number;
- (3) Wall station and number and lift location, dimensions, elevations and description;
- (4) Nail locations, dimensions and inclinations, bar types, sizes and grades and temporary casing information;

- (5) Date and time drilling begins and ends, steel bars are inserted into drill holes, grout and shotcrete are mixed and arrives on-site and grout placement and shotcrete application begins and ends;
- (6) Grout volume, temperature, flow and density records;
- (7) Ground and surface water conditions and elevations if applicable;
- (8) Weather conditions including air temperature at time of grout placement and shotcrete application; and
- (9) All other pertinent details related to soil nail wall construction.

After completing each soil nail wall or stage of a wall, provide a PDF file of all corresponding construction records.

Nail Testing

“Proof tests” are performed on nails incorporated into walls, i.e., production nails. Define “test nail” as a nail tested with a proof test. Proof tests are typically required for at least one nail per nail row per soil nail wall or at least 5% of production nails, whichever is greater. More or less test nails may be required depending on subsurface conditions encountered. The Engineer will determine the number and locations of proof tests required. Do not test nails until grout and shotcrete attain the required 3-day compressive strength.

(A) Test Equipment

Use the following equipment to test nails:

- (1) Two dial gauges with rigid supports,
- (2) Hydraulic jack and pressure gauge and
- (3) Jacking block or reaction frame.

Provide dial gauges with enough range and precision to measure the maximum test nail movement to 0.001". Use pressure gauges graduated in 100 psi increments or less. Submit identification numbers and calibration records for load cells, jacks and pressure gauges with the soil nail wall design. Calibrate each jack and pressure gauge as a unit.

Align test equipment to uniformly and evenly load test nails. Use a jacking block or reaction frame that does not damage or contact shotcrete within 3 ft of nail heads. Place dial gauges opposite each other on either side of test nails and align gauges within 5° of bar inclinations. Set up test equipment so resetting or repositioning equipment during nail testing is not needed.

(B) Test Nails

Test nails include both unbonded and bond lengths. Grout only bond lengths before nail testing. Provide unbonded and bond lengths of at least 3 ft and 10 ft, respectively.

Steel bars for production nails may be overstressed under higher test nail loads. If necessary, use larger size or higher grade bars with more capacity for test nails instead of shortening bond lengths to less than the minimum required.

(C) Proof Tests

Test proof test nails in accordance with the accepted submittals and Article 34.5.5.3, respectively of the *AASHTO LRFD Bridge Construction Specifications*.

(D) Test Nail Acceptance

Submit 2 copies of test nail records including load versus movement and time versus creep movement plots within 24 hours of completing each proof test. The Engineer will review the test nail records to determine if test nails are acceptable. Test nail acceptance is based in part on the acceptance criteria in Article 34.5.5.4 of the *AASHTO LRFD Bridge Construction Specifications*.

Maintain stability of unbonded lengths for subsequent grouting. If a test nail is accepted but the unbonded length cannot be satisfactorily grouted, do not incorporate the test nail into the soil nail wall and add another production nail to replace the test nail.

If the Engineer determines a test nail is unacceptable, either perform additional proof tests on adjacent production nails or revise the soil nail design or installation methods for the production nails represented by the unacceptable test nail as determined by the Engineer. Submit a revised soil nail wall design for acceptance, provide an acceptable test nail with the revised design or installation methods and install additional production nails for the nails represented by the unacceptable test nail.

After completing nail testing for each soil nail wall or stage of a wall, provide a PDF file of all corresponding test nail records.

Measurement and Payment

Temporary soil nail walls will be measured and paid in square feet. Temporary soil nail walls will be paid for at the contract unit price for *Temporary Shoring*. Temporary soil nail walls will be measured as the square feet of exposed wall face area. No measurement will be made for any embedment or pavement thickness above soil nail walls.

The contract unit price for *Temporary Shoring* will be full compensation for providing soil nail wall designs, submittals, labor, tools, equipment and soil nail wall materials, excavating, hauling and removing excavated materials, installing and testing soil nails, grouting, shotcreting and supplying sheet drains and any incidentals necessary to construct soil nail walls. No additional payment will be made and no extension of completion date or time will be allowed for repairing property damage, overexcavations or unstable excavations, unacceptable test nails or thicker shotcrete.

No payment will be made for temporary shoring not shown in the plans or required by the Engineer including shoring for OSHA reasons or the Contractor's convenience. No value engineering proposals will be accepted based solely on revising or eliminating shoring locations shown in the plans or estimated quantities shown in the bid item sheets as a result of actual field measurements or site conditions.

PCB will be measured and paid in accordance with Section 1170 of the *Standard Specifications*. No additional payment will be made for anchoring PCB for soil nail walls. Costs for anchoring PCB will be incidental to soil nail walls.

Temporary guardrail will be measured and paid for in accordance with Section 862 of the *Standard Specifications*.



DocuSigned by:
Scott A. Hidden
F760CAEB96FC4D3...

01/24/2024

STANDARD SHORING:**(1-16-24)****Description**

Standard shoring includes standard temporary shoring and standard temporary mechanically stabilized earth (MSE) walls. At the Contractor's option, use standard shoring as noted in the plans or as directed. When using standard shoring, a temporary shoring design submittal is not required. Construct standard shoring based on actual elevations and shoring dimensions in accordance with the contract and Geotechnical Standard Detail No. 1801.01 or 1801.02.

Define "standard temporary shoring" as cantilever shoring that meets the standard temporary shoring detail (Geotechnical Standard Detail No. 1801.01). Define "standard temporary wall" as a temporary MSE wall with geotextile or geogrid reinforcement that meets the standard temporary wall detail (Geotechnical Standard Detail No. 1801.02). Define "standard temporary geotextile wall" as a standard temporary wall with geotextile reinforcement and "standard temporary geogrid wall" as a standard temporary wall with geogrid reinforcement.

Provide positive protection for standard shoring at locations shown in the plans and as directed. See *Temporary Shoring* provision for positive protection types and definitions.

Materials

Refer to the *Standard Specifications*.

Item	Section
Concrete Barrier Materials	1170-2
Flowable Fill, Excavatable	1000-7
Geosynthetics	1056
Grout, Type 1	1003
Portland Cement Concrete, Class A	1000
Select Materials	1016
Steel Beam Guardrail Materials	862-2
Steel Sheet Piles and H-Piles	1084
Untreated Timber	1082-2
Welded Wire Reinforcement	1070-3

Provide Type 6 material certifications for shoring materials. Use Class IV select material for temporary guardrail. Use Class A concrete that meets Article 450-2 of the *Standard Specifications* or Type 1 grout for drilled-in piles.

Based on actual shoring height, positive protection, groundwater elevation, slope or surcharge case and traffic impact at each standard temporary shoring location, use sheet piles with the minimum required section modulus or H-piles with the sizes shown in Geotechnical Standard Detail No. 1801.01. Use untreated timber with a thickness of at least 3" and a bending stress of at least 1,000 psi for timber lagging.

(A) Shoring Backfill

Use Class II, Type 1, Class III, Class V or Class VI select material or material that meets AASHTO M 145 for soil classification A-2-4 with a maximum PI of 6 for shoring backfill except do not use the following:

- (1) A-2-4 soil for backfill around culverts,

- (2) A-2-4 soil in the reinforced zone of standard temporary walls with a back slope and
- (3) Class VI select material in the reinforced zone of standard temporary geotextile walls.

(B) Standard Temporary Walls

Use welded wire reinforcement for welded wire facing, struts and wires with the dimensions and minimum wire sizes shown in Geotechnical Standard Detail No. 1801.02. Provide Type 2 geotextile for separation and retention geotextiles. Do not use more than 4 different reinforcement strengths for each standard temporary wall.

(1) Geotextile Reinforcement

Provide Type 4a geotextile for geotextile reinforcement except for the ultimate tensile strength. Based on actual wall height, groundwater elevation, slope or surcharge case and shoring backfill to be used in the reinforced zone at each standard temporary geotextile wall location, provide geotextiles with ultimate tensile strengths as shown in Geotechnical Standard Detail No. 1801.02.

(2) Geogrid Reinforcement

Use geogrids for geogrid reinforcement with a roll width of at least 4 ft and an “approved” status code in accordance with the NCDOT Geosynthetic Reinforcement Evaluation Program. The list of approved geogrids is available from:

connect.ncdot.gov/resources/Geological/Pages/Products.aspx

Based on actual wall height, groundwater or flood elevation, slope or surcharge case and shoring backfill to be used in the reinforced zone at each standard temporary geogrid wall location, provide geogrids for geogrid reinforcement with short-term design strengths as shown in Geotechnical Standard Detail No. 1801.02. Geogrids are approved for short-term design strengths (3-year design life) in the machine direction (MD) and cross-machine direction (CD) based on material type. Define material type from the website above for shoring backfill as follows:

Material Type	Shoring Backfill
Borrow	A-2-4 Soil
Fine Aggregate	Class II, Type 1 or Class III Select Material
Coarse Aggregate	Class V or VI Select Material

Preconstruction Requirements

(A) Concrete Barrier

Define “clear distance” behind concrete barrier as the horizontal distance between the barrier and edge of pavement. The minimum required clear distance for concrete barrier is shown in the plans. At the Contractor’s option or if the minimum required clear distance is not available, set concrete barrier next to and up against traffic side of standard shoring except for barrier above standard temporary walls. Concrete barrier with the minimum required clear distance is required above standard temporary walls.

(B) Temporary Guardrail

Define “clear distance” behind temporary guardrail as the horizontal distance between guardrail posts and standard shoring. At the Contractor’s option or if clear distance for standard temporary shoring is less than 4 ft, attach guardrail to traffic side of shoring as shown in the plans. Place ABC in clear distance and around guardrail posts instead of pavement. Do not use temporary guardrail above standard temporary walls.

(C) Standard Shoring Selection Forms

Before beginning standard shoring construction, survey existing ground elevations in the vicinity of standard shoring locations to determine actual shoring or wall heights (H). Submit a standard shoring selection form for each location at least 7 days before starting standard shoring construction. Standard shoring selection forms are available from: connect.ncdot.gov/resources/Geological/Pages/Geotech_Forms_Details.aspx

Construction Methods

Construct standard shoring in accordance with the *Temporary Shoring* provision.

(A) Standard Temporary Shoring Installation

Based on actual shoring height, positive protection, groundwater elevation, slope or surcharge case and traffic impact at each standard temporary shoring location, install piles with the minimum required embedment and extension for each shoring section in accordance with Geotechnical Standard Detail No. 1801.01. For concrete barrier above and next to standard temporary shoring and temporary guardrail above and attached to standard temporary shoring, use “surcharge case with traffic impact” in accordance with Geotechnical Standard Detail No. 1801.01. Otherwise, use “slope or surcharge case with no traffic impact” in accordance with Geotechnical Standard Detail No. 1801.01. If refusal is reached before driven piles attain the minimum required embedment, use drilled-in H-piles with timber lagging for standard temporary shoring.

(B) Standard Temporary Walls Installation

Based on actual wall height, groundwater elevation, slope or surcharge case, geotextile or geogrid reinforcement and shoring backfill in the reinforced zone at each standard temporary wall location, construct walls with the minimum required reinforcement length and number of reinforcement layers for each wall section in accordance with Geotechnical Standard Detail No. 1801.02. For standard temporary walls with pile foundations in the reinforced zone, drive piles through reinforcement after constructing temporary walls.

For standard temporary walls with interior angles less than 90°, wrap geosynthetics at acute corners as directed by the Engineer. Place geosynthetics as shown in Geotechnical Standard Detail No. 1801.02. Place separation geotextiles between shoring backfill and backfill, natural ground or culverts along the sides of the reinforced zone perpendicular to the wall face. For Class V or VI select material in the reinforced zone, place separation geotextiles between shoring backfill and backfill or natural ground on top of and at the back of the reinforced zone.

Measurement and Payment

Standard shoring will be measured and paid in accordance with the *Temporary Shoring* provision.



DocuSigned by:
Scott A. Hidden
F760CAEB96FC4D3...
01/24/2024

ARCHITECTURAL CONCRETE SURFACE TREATMENT**(SPECIAL)****1.0 GENERAL**

The work covered by this special provision consists of constructing textured surfaces on formed reinforced concrete surfaces as indicated on the Plans and in this Special Provision. The Contractor shall furnish all materials, labor, equipment, and incidentals necessary for the construction of architectural concrete surface treatment using simulated stone masonry form liners (molds) and a compatible concrete coloring system.

The architectural concrete surface treatment should match the appearance (stone size and shape, stone color, and stone texture, pattern, and relief) of natural stone and rock as directed by the Engineer. Grout pattern joints (mortar joints) and bed thickness should recreate the appearance and color of precast concrete surfaces as indicated in the Plans, this Special Provision, or as directed by the Engineer.

2.0 SUBMITTALS

Shop Drawings - Submit for review and acceptance, a PDF file for plan and elevation views and details showing overall simulated stone pattern, joint locations and end, edge or other special conditions. The drawings should include typical cross sections of applicable surfaces, joints, corners, stone relief, stone size, pitch/working line, mortar joint and bed depths. If necessary, revise the shop drawings until the proposed form liner patterns and arrangement have been accepted by the Engineer. The PDF file of shop drawings should be 22 inch x 34 inch in size and have enough resolution to show the details of all stone and joints patterns as well as overall appearance.

The form liner shall be patterned such that long continuous horizontal or vertical lines do not occur on the finished exposed surface. The line pattern shall be random in nature and shall minimize construction joint lines. The top of wall must have untreated, non-textured, and uncolored areas within the distance from the top of wall to the bottom of the coping.

Shop drawings shall be reviewed and accepted prior to fabrication of form liners.

Sample Panels – After the shop drawings have been reviewed and accepted by the Engineer, submit a precast sample panel to the project site. The sample panel shall be transportable and minimum 4 foot x 4 foot in size. The materials used in construction of the sample panel shall comply with section 420 of the Standard Specifications. The sample panel shall be constructed using approved form liners and color system/stains. The sample panel can be colored on the project site in accordance with this provision. Any sample panel that is not accepted by the Engineer is to be removed from the project site and a new sample panel produced at no additional expense to the Department.

After the color, texture, and uniformity of the furnished samples are approved, produce a full scale unit meeting the design requirements. This mock-up and the furnished samples establish the standard quality for determining the acceptance of the panels.

Architectural surface treatments and patterns of the finished work shall achieve the same final effect as demonstrated on the accepted sample panels. Upon acceptance by the Engineer, the sample panels shall be used as the quality standard for the project. After the acceptance of the completed structure, dispose of the sample panels as directed by the Engineer.

3.0 MATERIALS REQUIREMENTS

Form Liner – The form liner shall be a high quality, re-useable product manufactured of high strength urethane rubber or other approved material which attaches easily to the form work system, and shall not compress more than ¼ inch when concrete is poured at a rate of 10 vertical feet per hour. The form liners shall be removable without causing deterioration of the surface or underlying concrete.

The architectural concrete surface treatment shall match the appearance (stone size and shape, stone texture, pattern, relief and joint) of natural stone to resemble an ashlar stone pattern or approved equal. All texture shall be in addition to the nominal thickness of the wall panels of four inches \pm ¼ inch. The maximum relief of the textured surface shall be 1.5 inch or less. The top 1'-0" of the top panel within each sound barrier wall segment shall have a smooth, non-textured and non-stained finish to resemble faux coping. For information purposes only, sources of form liners in the ashlar stone pattern include, but are not limited to:

Custom Rock Formliner
2020 West 7th Street
St. Paul, MN 55116
<http://www.customrock.com>
Pattern: Ashlar Stone # 12021

Architectural Polymers, Inc.
1220 Little Gap Road
Palmerton, PA 18071
<http://www.apformliner.com/>
Pattern: Ashlar Stone #904

Fitzgerald Form Liners
1500 East Chestnut Avenue
Santa Ana, CA 92701
<http://formliners.com/>
Pattern: Georgia Ashlar # 16999

The contractor has the option of supplying an alternative pattern of simulated stone form liner, as long as the pattern selected is approved, in writing, as an equal or approved alternative by the Engineer.

Form Release Agent – Form release agent shall be a non-staining petroleum distillate free from water, asphaltic, and other insoluble residue, or an equivalent product. Form release agents shall be compatible with the color system applied and any special surface finish.

Concrete color system/stain – The final coloration of the wall is to match the Grey Palette Color # FS 36176 found in the *Federal Standard 595B - Colors Used in Government Procurement*. Stain the sample panel using the proposed colors and the approved sample panel shall be the basis for determining the appropriate color/stain application.

The concrete color stains shall create a surface finish that is breathable (allowing water vapor transmission), and that resists deterioration from water, acid, alkali, fungi, sunlight, or weathering. Stain mix shall meet the requirements for mildew resistance of Federal Test Method Standard 144, Method 6271, and requirements for weathering resistance of 1,000 hours accelerated exposure measures by Weatherometer in accordance with ASTM G 26. Color samples must be submitted for approval.

Anti-Graffiti Coating Application – Apply the anti-graffiti coating that is compatible with the concrete color system/stain. After application, the anti-graffiti coating shall be dry to touch within one hour and shall achieve a final cure within three hours. The color of the anti-graffiti shall be clear after full cure. The contractor shall provide one gallon of graffiti remover, thinners, dryers and all necessary components recommended by the manufacturer to the North Carolina Department of Transportation Materials and Test Unit, Chemical Testing Engineer.

Quality Standards - Manufacturer of simulated stone masonry form liners and custom coloring system shall have at least five years of experience making stone masonry molds and color stains to create formed concrete surfaces to match natural stone shapes, surface textures and colors.

After the Engineer has reviewed and approved the shop drawings, schedule a preconstruction conference with manufacturer representative and the Engineer to assure understanding of simulated stone masonry form liner use, color application, requirements for construction of sample panels, and to coordinate the work. Disclose the source of simulated stone masonry manufacturer and final coloration contractor at the Preconstruction Conference.

4.0 CONSTRUCTION METHODS

Form Liner Preparation – Before each concrete pour, the form liners shall be clean and free of build-up. Each liner shall be visually inspected for blemishes and tears. Repairs shall be made in accordance with the manufacturer's recommendations. Repairs shall be accepted by the Engineer before being used. Form liner panels that do not perform as intended or are no longer repairable shall be replaced. Use a technical representative from the form liner manufacturer for technical supervision during the installation and removal of form liners.

Form Release Agent – Form release agent shall be applied in accordance with the manufacturer's recommendations. The material shall be compatible with the form liner material and the concrete coloring system and in accordance with this Special Provision. Form release agent should be worked into all areas, especially pattern recesses.

Patching – All form tie holes and other defects in finished uncolored surface shall be filled or repaired within 48 hours of form removal. Use patching materials and procedures in accordance with the manufacturer's recommendations.

Surface Finish – All surfaces that are to receive coloring agent application shall be free of all laitance, dirt, dust, grease, efflorescence, paint or any other foreign material prior to the application of coloring agent. Pressure washing with water is the preferred method of removing laitances. Sandblasting will not be permitted.

Final surface shall be free of blemishes, discolorations, surface voids, and other irregularities. All patterns should be continuous without visual disruption.

Reinforced concrete shall be finished in accordance with the Standard Specifications, except that curing of concrete should be done to accommodate the application of coloring and surface finish treatment.

Grout Pattern Joints – Grout pattern joints shall be constructed to simulate the appearance of mortared joints produced in laid up masonry work. Grout pattern joints shall be produced in accordance with the form liner / concrete color system manufacturer.

Color/Stain Application – Maintain the concrete temperature between 40°F and 85°F during color/stain application and for 48 hours after color/stain application. Consult the manufacturer's recommendations for preparation, application, curing, and storage of coloring agents/stains. Treated surfaces located adjacent to exposed soil or pavement shall be temporarily covered to prevent dirt or soil splatter from rain.

Anti-Graffiti Coating Application – The anti-graffiti coating shall be applied by brush, roller or airless spray when the ambient temperature is between 40°F and 90°F, and the surface temperature is between 50° F and 100° F. Ensure the surface is clean and dry before applying the anti-graffiti coating. The minimum dry film thickness of the anti-graffiti coating shall be 2.0 mils.

Following the completion of all work, repairs of any damage made by other construction operations shall be made to the form lined and colored surfaces as directed by the Engineer.

Experience and Qualifications - The Contractor shall have a minimum of three consecutive years of experience in architectural concrete surface treatment construction on similar types of projects. A minimum of 10 days prior to the submission of shop drawings, furnish to the Engineer 5 references who were responsible for supervision of similar projects and will testify to the successful completion of these projects. Include name, address, telephone number, and specific type of application.

5.0 MEASUREMENT AND PAYMENT

The quantity of architectural concrete surface treatment to be paid for will be the actual number of square feet (meters) of architectural concrete surface treatment that has been incorporated into the completed and accepted work.

The area of architectural concrete surface treatment will be measured by the area of front facing in place treated concrete. Do not include the top surfaces and the end wall surfaces in the measurement. Area of sample panels shall not be included in the measurement of architectural concrete surface treatment.

6.0 BASIS OF PAYMENT

Architectural concrete surface treatment as described on the plans and in this Special Provision will be paid for at the contract unit price bid for “Architectural Concrete Surface Treatment”. The above price and payment will be full compensation for all work covered by this Special Provision, the plans and applicable parts of the Standard Specifications and shall include, but not be limited to, furnishing all labor, materials, equipment, and other incidentals, including sample panels, necessary to complete this work.

Payment will be made under:

Architectural Concrete Surface Treatment.....Square Feet

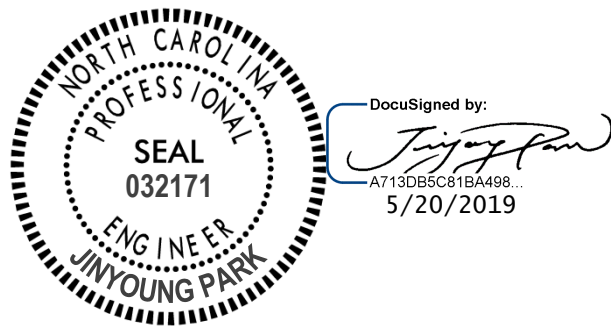

**PROJECT SPECIAL PROVISIONS
GEOENVIRONMENTAL**

CONTAMINATED SOIL (6/17/2022)

The Contractor's attention is directed to the fact that soil contaminated with petroleum hydrocarbon compounds may exist within the project area. The suspected areas of contamination are indicated on corresponding plans sheets. Information relating to these contaminated areas, sample locations, and investigation reports will be available at the following web address by navigating to the correct letting year and month then selecting, "Plans and Proposals", "Wake_B-4654", "Individual Sheets/520 GeoEnvironmental":

<http://dotw-xfer01.dot.state.nc.us/dsplan/>

Petroleum contaminated soil may be encountered during any earthwork activities on the project. The Contractor shall only excavate those soils that the Engineer designates necessary to complete a particular task. The Engineer shall determine if soil is contaminated based on areas shown on the plans, petroleum odors, and unusual soil staining. Contaminated soil not required to be excavated is to remain in place and undisturbed. Undisturbed soil shall remain in place, whether contaminated or not. The Contractor shall transport all contaminated soil excavated from the project to a facility licensed to accept contaminated soil.

In the event that a stockpile is needed, the stockpile shall be created within the property boundaries of the source material and in accordance with the Diagram for Temporary Containment and Treatment of Petroleum-Contaminated Soil per North Carolina Department of Environmental Quality's (NCDEQ) Division of Waste Management UST Section GUIDELINES FOR EX SITU PETROLEUM CONTAMINATED SOIL REMEDIATION. If the volume of contaminated material exceeds available space on site, the Contractor shall obtain a permit from the NCDEQ UST Section's Regional Office for off-site temporary storage. The Contractor shall provide copies of disposal manifests completed per the disposal facilities requirements and weigh tickets to the Engineer.

Measurement and Payment:

The quantity of contaminated soil hauled and disposed of shall be the actual number of tons of material, which has been acceptably transported and weighed with certified scales as documented by disposal manifests and weigh tickets. The quantity of contaminated soil, measured as provided above, shall be paid for at the contract unit price per ton for "Hauling and Disposal of Petroleum Contaminated Soil".

The above price and payment shall be full compensation for all work covered by this section, including, but not limited to stockpiling, loading, transportation, weighing, laboratory testing, disposal, equipment, decontamination of equipment, labor, and personal protective equipment.

Payment shall be made under:

Pay Item

Hauling and Disposal of Petroleum Contaminated Soil

Pay Unit

Ton

DocuSigned by:
Ethan J. Caldwell
E9A1CFAC49A241
06/17/2022



B-4654

ECS-1

Wake County

PROJECT SPECIAL PROVISIONS ELECTRICAL CONDUIT SYSTEM

1.0 DESCRIPTION

The work covered by this section consists of furnishing and installing electrical conduit system embedded in the bridge sidewalk and Classic Concrete Bridge Rail for roadway lighting to be installed by Duke Energy, on behalf of the Town of Garner, as shown in the plans. The conduit system in the Classic Concrete Bridge Rail includes anchor bolts for light standard attachments by others. Anchor bolts will be supplied by Duke Energy.

Perform all work in accordance with these special provisions, the plans, the National Electrical Code (NEC), and Division 14 of the North Carolina Department of Transportation "Standard Specifications for Roads and Structures."

The Contractor actually performing the work described in these special provisions shall have a license of the proper classification from the North Carolina State Board of Examiners of Electrical Contractors.

The licensed Electrical Contractor must be available on the job site when the work is being performed or when requested by the Engineer. The licensed Electrical Contractor shall have a set of plans and special provisions in possession on the job site and must maintain accurate "as built" plans.

A pre-construction meeting shall be held between the Contractor and Duke Energy representation prior to beginning the conduit installation.

2.0 MATERIALS

Submit electronic copies of catalog cuts and/or drawings for all proposed materials for the Engineer's review and approval. Include the brand name, stock number, description, size, rating, manufacturing specification, and applicable contract item number(s) on each submittal. Allow forty (40) days for submittal review. The Engineer will advise the Contractor of reasons for rejected submittals and will return approved submittals to the Contractor. Do not deliver material to the project prior to submittal approval.

Non-metallic conduit shall be rigid PVC (Polyvinyl Chloride) heavy wall approved for above ground and for underground use by direct burial or encasement in concrete per UL 651 "Rigid Non-Metallic Conduit". Use terminations designed for PVC conduit to seal and stub out each PVC conduit, and to provide watertight protection. Provide UL listed PVC expansion fittings of the appropriate size at all construction joints and bent expansion joints, as noted in the plans. Expansion fittings shall be weatherproof, designed for non-metallic conduit and provide 4" minimum of conduit movement.

The Preformed Concrete Handholes used in the bridge lighting conduit system are to be constructed to the dimensions as shown in the plans. The Preformed Concrete Handholes shall have a recessed flange for flush mounting sized as shown on the plans and shall have a neoprene

B-4654

ECS-2

Wake County

gasketed metal cover with brass or stainless-steel bolts and shall be suitable for a watertight installation, meeting NEMA Type-4 requirements. A mounting button with a blind tapped bolt hole shall be provided on the interior metal cover for future connection of a grounding lug. The handhole shall have a hot dipped galvanized replaceable metal cover with checkered imprint, reinforcing ribs, designed to Tier 22, minimum and include the Duke Energy logo. The covers shall be a standardized design so that replacement can be done without disturbing the handhole or conduit system.

Type IG30 junction boxes used with the bridge lighting system shall only be Polymer Concrete, not Thermoplastic and shall adhere to Section 1411 of the 2024 Standard Specifications for Roads and Structures.

Use mastic that is a permanent, non-hardening, water sealing compound that adheres to metal, plastic, and concrete.

Provide jute that is a burlap-like material used for filling voids and protecting components from waterproofing and adhesive compounds.

Provide pull lines specifically designed for pulling rope through conduit. Use pull lines made of 2-ply line, with a tensile strength of (240 pounds) minimum. Use rot and mildew resistant pull lines that are resistant to tangling when being dispensed.

Coordinate with Duke Energy to acquire the correct anchor bolt pattern for light pedestals installed on the structure.

3.0 CONSTRUCTION METHODS

Construct the preformed concrete handhole with a frame built of plywood or similar material encased with rigid foam insulation board or similar material that can easily be chiseled away and the frame removed once the concrete has hardened. Securely fasten all conduit and handhole frames prior to placing any concrete. Each conduit run between termination points should be as straight as possible. The total angular deflection of all bends in a conduit run should not exceed 180 degrees. Total deflection greater than 180 degrees requires advanced approval by the Engineer and Duke Energy project engineer. After the conduit is encased in concrete, clean each conduit by snaking with a steel band that has an approved tube cleaner, equipped with a mandrel of a diameter not less than 1/2" of the nominal inside diameter of the conduit. Coordinate conduit cleaning of the bridge lighting conduit system with Duke Energy personnel and have Duke Energy personnel on hand to witness cleaning.

Extend all conduits to an adequate length to the inside of the concrete formed handhole frame prior to pouring concrete. Adjust all conduit lengths after the handhole frame has been removed. Stub the bridge lighting conduit system out to the IG30 junction boxes as shown in the plans. Place backfill in accordance with Section 300-7 of the Standard Specifications. Use threaded adapter and PVC bushing at all handhole and junction box to conduit connections. Install a pull line in each conduit for future use. Leave sufficient slack for attachment of a rope that will be used to install conductors. Coordinate electrical conduit system work with work by others.

B-4654

ECS-3

Wake County

Install anchor bolts according to pattern provided by Duke Energy Progress. Protect exposed threaded portion of anchor bolts, to guard against damage from concrete installation.

Seal and cap all conduits exposed in the light pedestals on the structure.

All work must be inspected and approved by the Engineer before concealment.

Installation of circuitry and light standards will be provided by others and are not part of this contract.

4.0 MEASUREMENT AND PAYMENT

No direct measurement will be made for the conduit system(s) since it will be paid for on a lump sum basis.

Such price and payment for the “Electrical Conduit System at Station _____” as provided above will be considered full compensation for all materials, equipment, and labor necessary to install an electrical conduit system for bridge lighting in the bridge parapet, in the sidewalk across the bridge and approach slabs, underneath and behind the sidewalk located outside of the bridge and bridge approach slab limits, and underneath NC-50, in accordance with the plans and these special provisions.

Payment will be made under:

Electrical Conduit System at Station_____Lump Sum



DocuSigned by:
Thomas P. Gasser
 EEB6C2DE421A4E...
 1/11/2024

Project: B-4654

UC-1

County: Wake

PROJECT SPECIAL PROVISIONS
Utility Construction

	1/11/2024
<p>AECOM Technical Services of North Carolina, Inc. 5438 Wade Park Boulevard, Suite 200 Raleigh, NC 27607 Project Number: 60436195 B-4654 January 11, 2024</p>	
	<p>DocuSigned by: <i>D. Stephen Scruggs</i> (Seal) 957A10CE3D5E477...</p>

EXHIBIT C

**DOCUMENT NOT CONSIDERED FINAL
UNLESS ALL SIGNATURES COMPLETED**

General:

The existing potable water and sanitary sewer utilities within the project area (hereinafter “wet utilities”) belong to the City of Raleigh (hereinafter “Owner”). The Contractor shall provide access for the Owner’s representatives to all phases of construction. Testing, inspection, and acceptance shall be in accordance with the Owner’s requirements. Contractor shall coordinate with the Owner to ensure all testing, inspection, and documentation requirements are met.

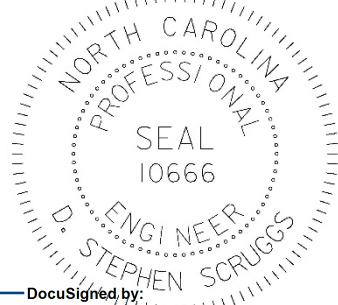
The proposed utility construction shall meet the applicable requirements of the NC Department of Transportation’s “Standard Specifications for Roads and Structures” (hereinafter “NCDOT Standard Specifications”) dated January 2024, the Owner’s “City of Raleigh Public Utilities Department Handbook” (hereinafter “CORPUD Handbook”) current edition, the City of Raleigh’s standard utility details, the Utility Construction design drawings, and the following Special Provisions.

Measurement and payment for proposed Utility Construction shall conform to the applicable requirements of the 2024 NCDOT Standard Specifications for Roads and Structures, as modified by these Special Provisions. If a discrepancy arises between the NCDOT Standard Specifications and the CORPUD Handbook that is not related to measurement and payment, the more stringent requirements shall prevail.

Any wet utility service outages shall take place at a time and date acceptable to the Owner, including nights and weekends, and shall be limited to no more than 8 hours per service interruption, unless otherwise specified on the drawings or by the Owner.

Project: B-4654

UC-2

County: Wake

PROJECT SPECIAL PROVISIONS

Utility Construction

Wet Utility Installation Plan

This work consists of preparation of an installation plan for each relocation, submitted by the Contractor to the Owner for review and approval.

For each wet utility relocation, the Contractor shall submit a plan, detailing the intended wet utility construction to the Owner for approval prior to installing any component of the proposed wet utility or interrupting wet utility service. The Plan shall include at minimum:

1. Schedule and Sequence
 - a. Proposed installation schedule and sequence including all connections to active pressure pipes (line stops, tapping sleeves, or cut-in work), connections to manholes, or other connections to the Owner's system, installation phasing, pressure testing, disinfection, flushing, water quality testing, service connection switchovers, and abandonment or removal of lines to be abandoned.
2. Shutdowns
 - a. For each phase of wet utility construction requiring a service outage (defined as the closure of one or more valves, resulting in depressurization of any portion of the existing system, including services), the Contractor shall provide the following:
 - i. Location of proposed work and justification for shutdown
 - ii. Schedule (date and time) and duration
 - iii. Affected customers.
3. Bypasses
 - a. For any work requiring bypass of portions of the existing wet utility system or other temporary piping, the Contractor shall provide the following:
 - a. Bypass piping layout, showing at minimum:
 - i. Position of all components of the bypass system, including but not limited to pumps (if applicable), piping, valves, connection points to the existing system, aerial crossing(s), and supports.
 - ii. Size, type, and material of all piping, control valves, and air release valve(s).
 - iii. Details of traffic or stream crossings
 - b. If the bypass will require pumps, the Contractor shall submit a bypass plan in accordance with the CORPUD handbook, sealed by a Professional Engineer, licensed in North Carolina.
 - c. Any plan which requires the use of elevated structures or other special supports, e.g. aerial crossings and other bridges, shall require certification by a Professional Engineer licensed in North Carolina. The Contractor shall provide the certification(s) at no additional cost to the Owner.

Project: B-4654

UC-3

County: Wake

PROJECT SPECIAL PROVISIONS

Utility Construction

Implementation of foregoing installation plans shall not commence until approval of the submittals required under this Section. The Owner's may, at its sole discretion, require an on-site preconstruction meeting prior to certain utility construction activities.

The Contractor shall allow sufficient time for review and approval of each submitted installation plan, including any test shutdowns required by Owner, and shall not be entitled to any delay claims related to review, rejection, resubmittal, modifications, or any other actions necessary to obtain approved installation plans.

Wet Utility Installation Plan is considered incidental to the utility line to which each plan applied. No measurement nor payment will be made.

As-Built Plans

Provide as-built plans of the installed wet utilities in accordance with the Owner's requirements. Final acceptance for service of wet utilities by the Owner is contingent upon the Contractor's submission of satisfactory as-built plans.

As-built plans must include the following data:

1. Horizontal and vertical coordinates (NC State Plane NAD83 northing, easting, and NAVD88 elevation) of the installed location for the following:
 - All fittings – Including but not limited to vertical and horizontal bends, tees, reducers, sleeves. Include size(s) and angle.
 - All utility controls – Including but not limited to valves, meters, fire hydrants, sampling stations, vaults, manholes, line stops installed as part of the project (whether abandoned or remaining active), and blow offs. Include size, type, and other descriptor(s) as applicable to specifically identify the control.
 - All cleanouts. Include size and material.
 - All piping – With survey points taken at intervals no greater than 100-feet along straight section, and 50-feet along curved sections.
 - Start and end points of restrained joint piping.
 - Start and end points of encasement pipes. Include size and material of encasement.
 - Start and end points trenchless installations, including but not limited to pipe installed by horizontal directional drill.
 - Sanitary sewer manholes and cleanouts. Include rim and each invert.

Note: The elevation coordinate for buried facilities must be the elevation of the buried facility and not the surface elevation.

Project: B-4654

UC-4

County: Wake

PROJECT SPECIAL PROVISIONS

Utility Construction

2. Size, material, and class of all piping, including identification of any special coatings or linings.
3. Identify new and existing facilities and connection point(s) to existing facilities.

Verify accuracy and completeness of as-built plans in the field with Owner's inspections staff prior to submittal. Submit as-built drawings in PDF format as well as Microstation or AutoCAD format, sealed by a surveyor licensed in the state of North Carolina, to the Owner for review and approval.

Revise the 2024 NCDOT Standard Specifications as follows:**Page 10-68; Sub-article 1036-8, Sleeves, Couplings and Miscellaneous**

add the following after Subparagraph (B):

(C) MJ Long Body Solid Sleeve Couplings and MJ Transition Sleeve Couplings

MJ Solid Sleeve Couplings shall be used to connect proposed ductile iron piping to existing ductile iron piping where shown on the Drawings. Solid sleeves shall be ductile iron, conforming to the requirements of ANSI A21.10 (AWWA C110).

Transition Couplings shall be used to connect proposed ductile iron piping to existing piping that is not ductile iron. Transition couplings shall be selected which are designed for the actual materials, outside diameters, condition, and utility of pipelines to be connected.

(D) Mechanical Joint Restraints

Mechanical joint restraints shall be selected which are designed for the intended application. Restraint devices shall consist of multiple gripping wedges incorporated into a follower gland meeting the applicable requirements of ANSI/AWWA C110/A21.10. The devices shall have a working pressure rating equal to or greater than the host pipe. Gland body, wedges and wedge actuating components shall be cast from grade 65-45-12 ductile iron material in accordance with ASTM A536. Ductile iron gripping wedges shall be heat treated within a range of 370 to 470 BHN.

Page 15-1, Sub-article 1500-2 Cooperation with the Utility Owner, paragraph 2:

add the following sentences:

The utility owner is the City of Raleigh. The contact person is Todd Toler and he can be reached by phone at 919-996-3476 and by email at Todd.Toler@raleighnc.gov.

Project: B-4654

UC-5

County: Wake

PROJECT SPECIAL PROVISIONS

Utility Construction

Page 15-4; Sub-article 1505-3, Construction Methods,
add the following after Subparagraph (F):

(G) Concrete Thrust Collars

Concrete thrust collars shall be installed where shown on the Plans and as required under Article 1505-3, Subparagraph (E). Concrete thrust collars shall be provided at the locations shown on the Plans or as requested by the Engineer. The excavation at such location(s) shall receive special attention with such undisturbed materials within as short a distance as possible from the pipe. Concrete thrust collars shall be installed in accordance with the Details S-6 and W-7, as shown on the Plans.

All reinforcing steel shall be Grade 60 in accordance with Article 1070-2. All concrete shall be Class AA in accordance with Article 1000-4.

(H) Reaction Blocking

All fittings or components subject to hydrostatic thrust shall be securely anchored by the use of concrete thrust blocks poured in place, unless otherwise directed by the Engineer. Where concrete must be reinforced, the Contractor shall furnish such reinforcing as is required.

Required thrust block sizing shall be per the schedule provided on the plans and installation shall be per the detail notes; see Details S-7 and W-9.

Material for reaction blocking shall be Class B in accordance with Article 1000-4. Any metallic component used in thrust restraint which is not encased in concrete shall be “hot dipped” galvanized or stainless steel.

Page 15-5; Sub-article 1505-6, Measurement and Payment,

delete Lines 20 and 21 and replace with:

(C) Shoring and Sheeting, including engineering design (excludes shoring specified or required for non-utility work)

add the following to Line 22: “including Thrust Collars and Reaction Blocking.”

Project: B-4654

UC-6

County: Wake

PROJECT SPECIAL PROVISIONS

Utility Construction

Page 15-8; Article 1515-2, Materials

add the following after Line 14:

Insertion valves shall be of ductile iron body with resilient wedge, meeting the requirements of AWWA C515, rated for a minimum working pressure of 250 PSI or greater. The valve design shall allow the valve to be installed while maintaining constant line pressure and service and such that after installation, the downstream piping can be completely removed.

For Insertion Valves 12" size and smaller, the host pipe shall not be a permanent component of the Insertion Valve and the valve wedge shall seat against the valve body, not the host pipe.

Page 15-9; Article 1515-3, Construction Methods

add the following after Line 30:

(H) Insertion Valves

Install insertion valves per manufacturer recommendations at the locations shown on the plans or as requested by the Engineer.

Split restraint devices designed for the host pipe size and material and consisting of multiple gripping wedges incorporated into a follower gland shall be installed on both sides of the valve and one thrust collar shall be installed on the "live" side of the insertion valve, between five (5) and ten (10) linear feet from the valve and rodded to the insertion valve. A concrete valve support shall be poured beneath the insertion valve.

Page 15-9; Article 1515-4, Measurement and Payment

add the following to Line 35:

Insertion Valves will be measured and paid per each for the appropriate size. All excavation and backfill, bedding, restraint devices (including thrust collar), other concrete, and appurtenances necessary for a fully operable insertion valve shall be considered incidental to the Insertion Valve pay item.

All *MJ Solid Sleeve Couplings and MJ Transition Sleeve Couplings* required for the Project shall be considered incidental to the ____" Water Line pay item. No additional measurement or payment will be made.

All *Mechanical Joint Restraints* shall be considered incidental to the ____" Water Line pay item. No additional measurement or payment will be made.

Project: B-4654

UC-7

County: Wake

PROJECT SPECIAL PROVISIONS

Utility Construction

All miscellaneous connections to existing pipe shall be installed in accordance with Article 1036-8 (B) and shall be considered as incidental to the Project and no additional payment will be made.

Owner and Owner's Requirements:

The existing potable water mains and sewer lines are owned by the entity listed above. The Contractor shall provide access for the owner's representatives to all phases of construction. The owner shall be notified two (2) weeks prior to commencement of any work and one (1) week prior to service interruption. Only authorized personnel of the owner shall operate valves in the existing water distribution system or sanitary sewer collection system.

End.

PROJECT SPECIAL PROVISIONS

Utilities by Others



Technical Services of North Carolina, Inc.
5438 Wake Park Blvd, Suite 200
Raleigh, NC 27607
Project Number: 60436195 B-4654
September 11, 2023

General:

The following utility companies have facilities that will be in conflict with the construction of this project:

- A. Power Distribution – Duke Energy
- B. CATV – Charter/Spectrum
- C. Telecom – Windstream
- D. Telecom- AT&T
- E. Gas - PSNC

The conflicting facilities of these concerns will be adjusted prior to the date of availability unless otherwise noted and are therefore listed in these special provisions for the benefit of the Contractor. All utility work listed herein will be done by the utility owners. All utilities are shown on the plans from the best available information.

Utilities Requiring Adjustment:

Utility relocations are shown on the Utilities by Others Plans.

PROJECT SPECIAL PROVISIONS

Utilities by Others

- A. Power Distribution – Duke Energy
Contact: George Cox @ 919-882-5074
7001 Pinecrest Rd, Raleigh, NC 27613
Duke Energy power relocations are complete.

- B. CATV – Charter/Spectrum
Contact: John Meyers @ 984-766-0923
789 S Selma Rd, Wendell, NC 27591
Charter/Spectrum relocations will be completed by the date of availability.

- C. Telecommunications – Windstream
Contact: Donald Fradel @ 919-863-1771
2111-103 Harrod St, Raleigh, NC 27562
Windstream relocations are complete.

- D. Telecommunications – AT&T
Contact: Brandt Vickers @ 919-758-6298
5715 Glenwood Ave, Raleigh, NC 27612
AT&T relocations will be completed by the date of availability.

- E. Gas - PSNC
Contact: Josue Alcaraz @ 919-367-2745
2020 Energy Dr, Apex, NC 27502
PSNC relocations are complete.

**Project Special Provisions
Erosion Control**

STABILIZATION REQUIREMENTS:

(4-30-2019)

Stabilization for this project shall comply with the time frame guidelines as specified by the NCG-010000 general construction permit effective April 1, 2019 issued by the North Carolina Department of Environmental Quality Division of Water Resources. Temporary or permanent ground cover stabilization shall occur within 7 calendar days from the last land-disturbing activity, with the following exceptions in which temporary or permanent ground cover shall be provided in 14 calendar days from the last land-disturbing activity:

- Slopes between 2:1 and 3:1, with a slope length of 10 ft. or less
- Slopes 3:1 or flatter, with a slope of length of 50 ft. or less
- Slopes 4:1 or flatter

The stabilization timeframe for High Quality Water (HQW) Zones shall be 7 calendar days with no exceptions for slope grades or lengths. High Quality Water Zones (HQW) Zones are defined by North Carolina Administrative Code 15A NCAC 04A.0105 (25). Temporary and permanent ground cover stabilization shall be achieved in accordance with the provisions in this contract and as directed.

SEEDING AND MULCHING:

(East)

The kinds of seed and fertilizer, and the rates of application of seed, fertilizer, and limestone, shall be as stated below. During periods of overlapping dates, the kind of seed to be used shall be determined. All rates are in pounds per acre.

All Roadway Areas

March 1 - August 31		September 1 - February 28	
50#	Tall Fescue	50#	Tall Fescue
10#	Centipede	10#	Centipede
25#	Bermudagrass (hulled)	35#	Bermudagrass (unhulled)
500#	Fertilizer	500#	Fertilizer
4000#	Limestone	4000#	Limestone

Waste and Borrow Locations

March 1 – August 31		September 1 - February 28	
75#	Tall Fescue	75#	Tall Fescue
25#	Bermudagrass (hulled)	35#	Bermudagrass (unhulled)
500#	Fertilizer	500#	Fertilizer
4000#	Limestone	4000#	Limestone

Note: 50# of Bahiagrass may be substituted for either Centipede or Bermudagrass only upon Engineer's request.

Approved Tall Fescue Cultivars

06 Dust	Escalade	Justice	Serengeti
2 nd Millennium	Essential	Kalahari	Shelby
3 rd Millennium	Evergreen 2	Kitty Hawk 2000	Sheridan
Apache III	Falcon IV	Legitimate	Signia
Avenger	Falcon NG	Lexington	Silver Hawk
Barlexas	Falcon V	LSD	Sliverstar
Barlexas II	Faith	Magellan	Shenandoah Elite
Bar Fa	Fat Cat	Matador	Sidewinder
Barrera	Festnova	Millennium SRP	Skyline
Barrington	Fidelity	Monet	Solara
Barrobusto	Finelawn Elite	Mustang 4	Southern Choice II
Barvado	Finelawn Xpress	Ninja 2	Speedway
Biltmore	Finesse II	Ol' Glory	Spyder LS
Bingo	Firebird	Olympic Gold	Sunset Gold
Bizem	Firecracker LS	Padre	Taccoa
Blackwatch	Firenza	Patagonia	Tanzania
Blade Runner II	Five Point	Pedigree	Trio
Bonsai	Focus	Picasso	Tahoe II
Braveheart	Forte	Piedmont	Talladega
Bravo	Garrison	Plantation	Tarheel
Bullseye	Gazelle II	Proseeds 5301	Terrano
Cannavaro	Gold Medallion	Prospect	Titan ltd
Catalyst	Grande 3	Pure Gold	Titanium LS
Cayenne	Greenbrooks	Quest	Tracer
Cessane Rz	Greenkeeper	Raptor II	Traverse SRP
Chipper	Gremlin	Rebel Exeda	Tulsa Time
Cochise IV	Greystone	Rebel Sentry	Turbo
Constitution	Guardian 21	Rebel IV	Turbo RZ
Corgi	Guardian 41	Regiment II	Tuxedo RZ
Corona	Hemi	Regenerate	Ultimate
Coyote	Honky Tonk	Rendition	Venture
Darlington	Hot Rod	Rhambler 2 SRP	Umbrella
Davinci	Hunter	Rembrandt	Van Gogh
Desire	Inferno	Reunion	Watchdog
Dominion	Innovator	Riverside	Wolfpack II
Dynamic	Integrity	RNP	Xtremegreen
Dynasty	Jaguar 3	Rocket	
Endeavor	Jamboree	Scorpion	

On cut and fill slopes 2:1 or steeper Centipede shall be applied at the rate of 5 pounds per acre and add 20# of Sericea Lespedeza from January 1 - December 31.

Fertilizer shall be 10-20-20 analysis. A different analysis of fertilizer may be used provided the 1-2-2 ratio is maintained and the rate of application adjusted to provide the same amount of plant food as a 10-20-20 analysis and as directed.

TEMPORARY SEEDING:

Fertilizer shall be the same analysis as specified for *Seeding and Mulching* and applied at the rate of 400 pounds and seeded at the rate of 50 pounds per acre. Sweet Sudan Grass, German Millet or Browntop Millet shall be used in summer months and Rye Grain during the remainder of the year. The Engineer will determine the exact dates for using each kind of seed.

FERTILIZER TOPDRESSING:

Fertilizer used for topdressing on all roadway areas except slopes 2:1 and steeper shall be 10-20-20 grade and shall be applied at the rate of 500 pounds per acre. A different analysis of fertilizer may be used provided the 1-2-2 ratio is maintained and the rate of application adjusted to provide the same amount of plant food as 10-20-20 analysis and as directed.

Fertilizer used for topdressing on slopes 2:1 and steeper and waste and borrow areas shall be 16-8-8 grade and shall be applied at the rate of 500 pounds per acre. A different analysis of fertilizer may be used provided the 2-1-1 ratio is maintained and the rate of application adjusted to provide the same amount of plant food as 16-8-8 analysis and as directed.

SUPPLEMENTAL SEEDING:

The kinds of seed and proportions shall be the same as specified for *Seeding and Mulching*, with the exception that no centipede seed will be used in the seed mix for supplemental seeding. The rate of application for supplemental seeding may vary from 25# to 75# per acre. The actual rate per acre will be determined prior to the time of topdressing and the Contractor will be notified in writing of the rate per acre, total quantity needed, and areas on which to apply the supplemental seed. Minimum tillage equipment, consisting of a sod seeder shall be used for incorporating seed into the soil as to prevent disturbance of existing vegetation. A clodbuster (ball and chain) may be used where degree of slope prevents the use of a sod seeder.

MOWING:

The minimum mowing height on this project shall be 4 inches.

LAWN TYPE APPEARANCE:

All areas adjacent to lawns must be hand finished as directed to give a lawn type appearance. Remove all trash, debris, and stones $\frac{3}{4}$ " and larger in diameter or other obstructions that could

interfere with providing a smooth lawn type appearance. These areas shall be reseeded to match their original vegetative conditions, unless directed otherwise by the Field Operations Engineer.

ENVIRONMENTALLY SENSITIVE AREAS:

Description

This project is located in an *Environmentally Sensitive Area*. This designation requires special procedures to be used for clearing and grubbing, temporary stream crossings, and grading operations within the Environmentally Sensitive Areas identified on the plans and as designated by the Engineer. This also requires special procedures to be used for seeding and mulching and staged seeding within the project.

The Environmentally Sensitive Area shall be defined as a 50-foot buffer zone on both sides of the stream or depression measured from top of streambank or center of depression.

Construction Methods

(A) Clearing and Grubbing

In areas identified as Environmentally Sensitive Areas, the Contractor may perform clearing operations, but not grubbing operations until immediately prior to beginning grading operations as described in Article 200-1 of the *Standard Specifications*. Only clearing operations (not grubbing) shall be allowed in this buffer zone until immediately prior to beginning grading operations. Erosion control devices shall be installed immediately following the clearing operation.

(B) Grading

Once grading operations begin in identified Environmentally Sensitive Areas, work shall progress in a continuous manner until complete. All construction within these areas shall progress in a continuous manner such that each phase is complete and areas are permanently stabilized prior to beginning of next phase. Failure on the part of the Contractor to complete any phase of construction in a continuous manner in Environmentally Sensitive Areas will be just cause for the Engineer to direct the suspension of work in accordance with Article 108-7 of the *Standard Specifications*.

(C) Temporary Stream Crossings

Any crossing of streams within the limits of this project shall be accomplished in accordance with the requirements of Subarticle 107-12 of the *Standard Specifications*.

(D) Seeding and Mulching

Seeding and mulching shall be performed in accordance with Section 1660 of the *Standard Specifications* and vegetative cover sufficient to restrain erosion shall be installed immediately following grade establishment.

Seeding and mulching shall be performed on the areas disturbed by construction immediately following final grade establishment. No appreciable time shall lapse into the contract time without stabilization of slopes, ditches and other areas within the Environmentally Sensitive Areas.

(E) Stage Seeding

The work covered by this section shall consist of the establishment of a vegetative cover on cut and fill slopes as grading progresses. Seeding and mulching shall be done in stages on cut and fill slopes that are greater than 20 feet in height measured along the slope, or greater than 2 acres in area. Each stage shall not exceed the limits stated above.

Additional payments will not be made for the requirements of this section, as the cost for this work shall be included in the contract unit prices for the work involved.

MINIMIZE REMOVAL OF VEGETATION:

The Contractor shall minimize removal of vegetation within project limits to the maximum extent practicable. Vegetation along stream banks and adjacent to other jurisdictional resources outside the construction limits shall only be removed upon approval of Engineer. No additional payment will be made for this minimization work.

CONSTRUCTION MATERIALS MANAGEMENT

(3-19-19) (rev. 04-27-20)

Description

The requirements set forth shall be adhered to in order to meet the applicable materials handling requirements of the NCG010000 permit. Structural controls installed to manage construction materials stored or used on site shall be shown on the E&SC Plan. Requirements for handling materials on construction sites shall be as follows:

Polyacrylamides (PAMS) and Flocculants

Polyacrylamides (PAMS) and flocculants shall be stored in leak-proof containers that are kept under storm-resistant cover or surrounded by secondary containment structures designed to protect adjacent surface waters. PAMS or other flocculants used shall be selected from the NC DWR List of Approved PAMS/Flocculants. The concentration of PAMS and other flocculants used shall not exceed those specified in the NC DWR List of Approved PAMS/Flocculants and in accordance

with the manufacturer's instructions. The NC DWR List of Approved PAMS/Flocculants is available at:

https://files.nc.gov/ncdeq/Water+Quality/Environmental+Sciences/ATU/PAM8_30_18.pdf

Equipment Fluids

Fuels, lubricants, coolants, and hydraulic fluids, and other petroleum products shall be handled and disposed of in a manner so as not to enter surface or ground waters and in accordance with applicable state and federal regulations. Equipment used on the site must be operated and maintained properly to prevent discharge of fluids. Equipment, vehicle, and other wash waters shall not be discharged into E&SC basins or other E&SC devices. Alternative controls should be provided such that there is no discharge of soaps, solvents, or detergents.

Waste Materials

Construction materials and land clearing waste shall be disposed of in accordance with North Carolina General Statutes, Chapter 130A, Article 9 - Solid Waste Management, and rules governing the disposal of solid waste (15A NCAC 13B). Areas dedicated for managing construction material and land clearing waste shall be at least 50 feet away from storm drain inlets and surface waters unless it can be shown that no other alternatives are reasonably available. Paint and other liquid construction material waste shall not be dumped into storm drains. Paint and other liquid construction waste washouts should be located at least 50 feet away from storm drain inlets unless there is no alternative. Other options are to install lined washouts or use portable, removable bags or bins. Hazardous or toxic waste shall be managed in accordance with the federal Resource Conservation and Recovery Act (RCRA) and NC Hazardous Waste Rules at 15A NCAC, Subchapter 13A. Litter and sanitary waste shall be managed in a manner to prevent it from entering jurisdictional waters and shall be disposed of offsite.

Herbicide, Pesticide, and Rodenticides

Herbicide, pesticide, and rodenticides shall be stored and applied in accordance with the Federal Insecticide, Fungicide, and Rodenticide Act, North Carolina Pesticide Law of 1971 and labeling restrictions.

Concrete Materials

Concrete materials onsite, including excess concrete, must be controlled and managed to avoid contact with surface waters, wetlands or buffers. No concrete or cement slurry shall be discharged from the site. (Note that discharges from onsite concrete plants require coverage under a separate NPDES permit – NCG140000.) Concrete wash water shall be managed in accordance with the *Concrete Washout Structure* provision. Concrete slurry shall be managed and disposed of in accordance with *NCDOT DGS and HOS DCAR Distribution of Class A Residuals Statewide* (Permit No. WQ0035749). Any hardened concrete residue will be disposed of, or recycled on site, in accordance with state solid waste regulations.

Earthen Material Stock Piles

Earthen material stock piles shall be located at least 50 feet away from storm drain inlets and surface waters unless it can be shown that no other alternatives are reasonably available.

Measurement and Payment

Conditions set within the *Construction Materials Management* provision are incidental to the project for which no direct compensation will be made.

WASTE AND BORROW SOURCES:

(2-16-11) (Rev. 3-17-22)

Payment for temporary erosion control measures, except those made necessary by the Contractor's own negligence or for his own convenience, will be paid for at the appropriate contract unit price for the devices or measures utilized in borrow sources and waste areas.

No additional payment will be made for erosion control devices or permanent seeding and mulching in any commercial borrow or waste pit. All erosion and sediment control practices that may be required on a commercial borrow or waste site will be done at the Contractor's expense.

All offsite Staging Areas, Borrow and Waste sites shall be in accordance with "Borrow and Waste Site Reclamation Procedures for Contracted Projects" located at:

<https://connect.ncdot.gov/resources/roadside/FieldOperationsDocuments/Contract%20Reclamation%20Procedures.pdf>

All forms and documents referenced in the "Borrow and Waste Site Reclamation Procedures for Contracted Projects" shall be included with the reclamation plans for offsite staging areas, and borrow and waste sites.

SAFETY FENCE AND JURISDICTIONAL FLAGGING:**Description**

Safety Fence shall consist of furnishing materials, installing and maintaining polyethylene or polypropylene fence along the outside riparian buffer, wetland, or water boundary, or other boundaries located within the construction corridor to mark the areas that have been approved to infringe within the buffer, wetland, endangered vegetation, culturally sensitive areas or water. The fence shall be installed prior to any land disturbing activities.

Interior boundaries for jurisdictional areas noted above shall be delineated by stakes and highly visible flagging.

Jurisdictional boundaries at staging areas, waste sites, or borrow pits, whether considered outside or interior boundaries shall be delineated by stakes and highly visible flagging.

Materials**(A) Safety Fencing**

Polyethylene or polypropylene fence shall be a highly visible preconstructed safety fence approved by the Engineer. The fence material shall have an ultraviolet coating.

Either wood posts or steel posts may be used. Wood posts shall be hardwood with a wedge or pencil tip at one end, and shall be at least 5 ft. in length with a minimum nominal 2" x 2" cross section. Steel posts shall be at least 5 ft. in length, and have a minimum weight of 0.85 lb/ft of length.

(B) Boundary Flagging

Wooden stakes shall be 4 feet in length with a minimum nominal 3/4" x 1-3/4" cross section. The flagging shall be at least 1" in width. The flagging material shall be vinyl and shall be orange in color and highly visible.

Construction Methods

No additional clearing and grubbing is anticipated for the installation of this fence. The fence shall be erected to conform to the general contour of the ground.

(A) Safety Fencing

Posts shall be set at a maximum spacing of 10 ft., maintained in a vertical position and hand set or set with a post driver. Posts shall be installed a minimum of 2 ft. into the ground. If hand set, all backfill material shall be thoroughly tamped. Wood posts may be sharpened to a dull point if power driven. Posts damaged by power driving shall be removed and replaced prior to final acceptance. The tops of all wood posts shall be cut at a 30-degree angle. The wood posts may, at the option of the Contractor, be cut at this angle either before or after the posts are erected.

The fence geotextile shall be attached to the wood posts with one 2" galvanized wire staple across each cable or to the steel posts with wire or other acceptable means.

Place construction stakes to establish the location of the safety fence in accordance with Article 105-9 or Article 801-1 of the *Standard Specifications*. No direct pay will be made for the staking of the safety fence. All stakeouts for safety fence shall be considered incidental to the work being paid for as "Construction Surveying", except that where there is no pay item for construction surveying, all safety fence stakeout will be performed by state forces.

The Contractor shall be required to maintain the safety fence in a satisfactory condition for the duration of the project as determined by the Engineer.

(B) Boundary Flagging

Boundary flagging delineation of interior boundaries shall consist of wooden stakes on 25 feet maximum intervals with highly visible orange flagging attached. Stakes shall be installed a minimum of 6” into the ground. Interior boundaries may be staked on a tangent that runs parallel to buffer but must not encroach on the buffer at any location. Interior boundaries of hand clearing shall be identified with a different colored flagging to distinguish it from mechanized clearing.

Boundary flagging delineation of interior boundaries will be placed in accordance with Article 105-9 or Article 801-1 of the *Standard Specifications*. No direct pay will be made for delineation of the interior boundaries. This delineation will be considered incidental to the work being paid for as *Construction Surveying*, except that where there is no pay item or construction surveying the cost of boundary flagging delineation shall be included in the unit prices bid for the various items in the contract. Installation for delineation of all jurisdictional boundaries at staging areas, waste sites, or borrow pits shall consist of wooden stakes on 25 feet maximum intervals with highly visible orange flagging attached. Stakes shall be installed a minimum of 6” into the ground. Additional flagging may be placed on overhanging vegetation to enhance visibility but does not substitute for installation of stakes.

Installation of boundary flagging for delineation of all jurisdictional boundaries at staging areas, waste sites, or borrow pits shall be performed in accordance with Subarticle 230-4(B)(5) or Subarticle 802-2(F) of the *Standard Specifications*. No direct pay will be made for this delineation, as the cost of same shall be included in the unit prices bid for the various items in the contract.

The Contractor shall be required to maintain alternative stakes and highly visible flagging in a satisfactory condition for the duration of the project as determined by the Engineer.

Measurement and Payment

Safety Fence will be measured and paid as the actual number of linear feet of polyethylene or polypropylene fence installed in place and accepted. Such payment will be full compensation including but not limited to furnishing and installing fence geotextile with necessary posts and post bracing, staples, tie wires, tools, equipment and incidentals necessary to complete this work.

Payment will be made under:

Pay Item
Safety Fence

Pay Unit
Linear Foot

CONCRETE WASHOUT STRUCTURE:

(8-17-23)

Description

Concrete washout structures are enclosures above or below grade to contain concrete waste water and associated concrete mix from washing out ready-mix trucks, drums, pumps, or other

equipment. Concrete washouts must collect and retain all the concrete washout water and solids, so that this material does not migrate to surface waters or into the ground water. These enclosures are not intended for concrete waste not associated with wash out operations.

The concrete washout structure may include constructed devices above or below ground and or commercially available devices designed specifically to capture concrete wash water.

Materials

Item	Section
Temporary Silt Fence	1605

Safety Fence shall meet the specifications as provided elsewhere in this contract.

Geomembrane basin liner shall meet the following minimum physical properties for low permeability; it shall consist of a polypropylene or polyethylene 10 mil thick geomembrane. If the minimum setback dimensions can be achieved the liner is not required. (5 feet above groundwater, 50 feet from top of bank of perennial stream, other surface water body, or wetland.)

Construction Methods

Build an enclosed earthen berm or excavate to form an enclosure in accordance with the details and as directed.

Install temporary silt fence around the perimeter of the enclosure in accordance with the details and as directed if structure is not located in an area where existing erosion and sedimentation control devices are capable to containing any loss of sediment.

Post a sign with the words “Concrete Washout” in close proximity of the concrete washout area, so it is clearly visible to site personnel. Install safety fence as directed for visibility to construction traffic.

Alternate details for accommodating concrete washout may be submitted for review and approval.

The alternate details shall include the method used to retain and dispose of concrete waste water within the project limits and in accordance with the minimum setback requirements. (5 feet above groundwater, 50 feet from top of bank of perennial stream, other surface water body, or wetland.)

Maintenance and Removal

Maintain the concrete washout structure(s) to provide adequate holding capacity plus a minimum freeboard of 12 inches. Remove and dispose of hardened concrete and return the structure to a functional condition after reaching 75% capacity.

Inspect concrete washout structures for damage and maintain for effectiveness.

Remove the concrete washout structures and sign upon project completion. Grade the earth material to match the existing contours and permanently seed and mulch area.

Measurement and Payment

Concrete Washout Structure will be paid for per each enclosure installed in accordance with the details. If alternate details or commercially available devices are approved, then those devices will also be paid for per each approved and installed device.

Temporary Silt Fence will be measured and paid for in accordance with Article 1605-5 of the *Standard Specifications*.

Safety Fence shall be measured and paid for as provided elsewhere in this contract.

No measurement will be made for other items or for over excavation or stockpiling.

Payment will be made under:

Pay Item	Pay Unit
Concrete Washout Structure	Each

LITTER REMOVAL (MOWING AREAS ONLY):
(07-19-22)

Description

This work consists of the pickup, removal, and disposal of litter from roadsides within the construction project prior to mowing operations.

Construction Methods

Provide labor, equipment and materials necessary for the pickup and removal of litter from non-construction sources and the disposal of same into state approved landfills. The Contractor shall abide by all ordinances, laws and regulations regarding disposal of litter and recycling of eligible materials. Wastes generated from construction activities shall be managed as provided elsewhere in the contract. Litter items may consist of any item not considered normal to the right-of-way, including but not limited to, varied sizes of bottles, cans, paper, tires, tire pieces, lumber, vehicle parts, building supplies, metals, household furnishings, cardboard, plastics, ladders, brush and other items not considered normal to the right of way. Litter removal shall be performed in designated areas within five days prior to any mowing operations and as directed. Designated areas shall include vegetated medians and shoulders within the project limits including all interchange ramps and other areas to be mown. Designated areas may be omitted for litter removal by the Engineer due to safety concerns.

The Contractor shall provide adequate personnel and materials to collect and remove litter. The Contractor shall be responsible for locating and utilizing approved local landfills and recycling

facilities. Refer to Section 105-27 of the *Standard Specifications* for potential hazardous materials. All collected litter shall be containerized immediately and kept off the traveled portions of the roadway, shoulders, and rights-of-way (including paved shoulders). All collected litter that is small enough to be placed in a bag shall be bagged immediately. All collected litter that is too large for a bag shall be placed into a vehicle. Extended storage or stockpiling of collected litter and recyclables will not be permitted.

The Contractor's personnel shall dispose of any litter in a landfill approved by North Carolina Division of Waste Management. The Contractor will not be allowed to use NCDOT accounts at the landfills/recycling centers nor be allowed to dispose of the litter in NCDOT trash containers on any NCDOT property.

The Contractor shall report online the number of bags of litter and any recycling on the NCDOT Litter Management Website on the date of the pickup at the following website:

<https://apps.ncdot.gov/LM>

An access code ('Pickup Key') for the online reporting portal may be obtained via emailing the Roadside Environmental Unit Litter Management Section at ncdot.clr@ncdot.gov. The Contractor shall request access to the litter removal reporting website prior to starting initial litter collection operations.

Measurement and Payment

The quantity of litter removal to be performed will be affected by the actual conditions that occur during construction of the project. The quantity of litter removal may be increased, decreased, or eliminated entirely as directed. Such variations in quantity will not be considered as alterations in the details of construction or a change in the character of the work.

Manual Litter Removal will be measured and paid as the actual number of man hours each worker spends picking up litter. Such price and payment will be full compensation for all litter removal work covered by *Litter Removal*, including, but not limited to, furnishing all materials, labor, equipment, transport, reporting, and incidentals necessary to accomplish the work.

Litter Disposal will be measured and paid for by the actual number of tons of litter collected and properly disposed of at a state approved landfill. Such price and payment will be full compensation for all fees, labor, transport, and incidentals necessary to dispose of collected litter associated with *Litter Removal*.

All traffic control necessary to provide a safe work area for *Litter Removal* shall be paid for as specified elsewhere in the contract.

Payment will be made under:

Pay Item	Pay Unit
Manual Litter Removal	MHR
Litter Disposal	TON

FABRIC INSERT INLET PROTECTION

(1-1-24)

Description

Install, maintain, and remove Fabric Insert Inlet Protection, of the type specified, in inlet structures (catch basins, drop inlets, etc.) in areas where asphalt or concrete may prevent the proper installation of a Rock Inlet Sediment Traps Type C, or as directed by the Engineer.

Materials

Provide a fabric inlet protection device composed of a fitted woven polypropylene geotextile double sewn with nylon thread suspended sack. The Fabric Insert Inlet Protection shall be manufactured to fit the opening of the catch basin or drop inlet or shall have a deflector to direct runoff from the curb opening into the fabric sack. The Fabric Insert Inlet Protection shall have a rigid frame or support system to support the loaded weight of the product. The product shall have lifting loops for removing the device from the basin and will have dump straps attached at the bottom to facilitate the emptying of the device. The Fabric Insert Inlet Protection shall have an overflow system to allow stormwater to enter the inlet structure and avoid ponding on the roadway when the device reaches capacity.

The fitted filter assembly shall have the following physical properties:

Type 1 (High Flow):

Physical	Test Method	English
Grab Tensile	ASTM D-4632	255 x 275 lbs
Minimum Puncture Strength	ASTM D-4833	125 lbs
Mullen Burst	ASTM D-3786	420 PSI
Minimum UV Resistance	ASTM D-4355	70 %.
Flow Rate	ASTM D-4491	200 gal/min/ft ²
Apparent Opening	ASTM D-4751	20 US Sieve
Permittivity	ASTM D-4491	1.5 sec ⁻¹

Type 2 (Low Flow):

Physical	Test Method	English
Grab Tensile	ASTM D-4632	315 x 300 lbs
Grab Elongation	ASTM D-4632	15 x 15 %
Minimum Puncture Strength	ASTM D-4833	125 lbs
Mullen Burst	ASTM D-3786	650 PSI
Minimum UV Resistance	ASTM D-4355	70 %.
Flow Rate	ASTM D-4491	40 gal/min/ft ²
Apparent Opening	ASTM D-4751	40 US Sieve
Permittivity	ASTM D-4491	0.55 sec ⁻¹

Construction Methods

Strictly adhere to the manufacturer's installation instructions and recommendations. Maintenance shall include regular daily inspections and after each qualifying rain event. The Fabric Insert Inlet Protection shall be emptied, cleaned and placed back into the basin when it reaches 50% capacity or as directed by the Engineer.

Measurement and Payment

Fabric Insert Inlet Protection, Type __ will be measured and paid in units of each of the type specified, complete in place and accepted. Such payment shall be full compensation for furnishing and installing the *Fabric Insert Inlet Protection, Type __* in accordance with this specification and for all required maintenance.

Fabric Insert Inlet Protection Cleanout will be measured and paid in units of each for the maintenance of the device, cleanout and disposal of accumulated sediments.

Payment will be made under:

Pay Item	Pay Unit
Fabric Insert Inlet Protection, Type __	Each
Fabric Insert Inlet Protection Cleanout	Each

B-4654

Signals and Intelligent Transportation Systems
Project Special Provisions
(Version 24.0)

Prepared By: J.A. Lohr
20-Dec-23

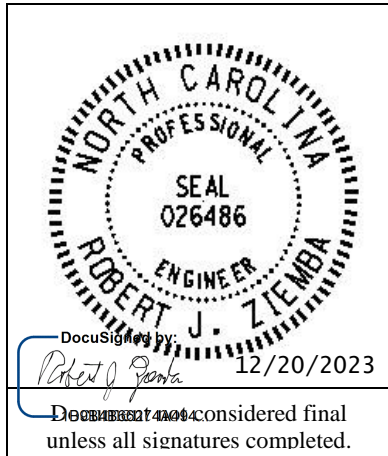

Contents

1. SIGNAL HEADS.....3

1.1. MATERIALS 3

 A. General: 3

 B. Vehicle Signal Heads:..... 4

 C. Pedestrian Signal Heads: 6

1.2. CONSTRUCTION METHODS 8

1.3. MEASUREMENT AND PAYMENT 8

2. CONTROLLERS WITH CABINETS 8

2.1. MATERIALS – TYPE 2070LX CONTROLLERS 8

2.2. MATERIALS – GENERAL CABINETS 9

2.3. MATERIALS – TYPE 170E CABINETS 10

 A. Type 170 E Cabinets General: 10

 B. Type 170 E Cabinet Electrical Requirements: 10

 C. Type 170 E Cabinet Physical Requirements: 17

 D. Model 2018 Enhanced Conflict Monitor: 18

2.4. MATERIALS – TYPE 170 DETECTOR SENSOR UNITS 27

3. MICROWAVE VEHICLE DETECTION SYSTEM - MULTIPLE DETECTION ZONES..... 27

3.1. DESCRIPTION 27

3.2. MATERIALS 27

3.3. CONSTRUCTION METHODS 29

3.4. MEASUREMENT AND PAYMENT 29

4. METAL POLE SUPPORTS 29

4.1. METAL POLES 29

 A. General: 29

 B. Materials: 31

 C. Design: 33

 D. Mast Arm Poles: 34

4.2. DRILLED PIER FOUNDATIONS FOR METAL POLES 36

 A. Description: 36

 B. Soil Test and Foundation Determination: 37

 C. Drilled Pier Construction: 39

4.3. POLE NUMBERING SYSTEM 39

4.4. MEASUREMENT AND PAYMENT 39

5. ETHERNET EDGE SWITCH..... 39

5.1. DESCRIPTION 39

 A. Ethernet Edge Switch: 39

 B. Network Management: 40

5.2. MATERIALS 40

- A. General: 40
- B. Compatibility Acceptance..... 40
- C. Standards: 40
- D. Functional: 41
- E. Physical Features: 41
- F. Management Capabilities: 42
- G. Electrical Specifications: 43
- H. Environmental Specifications: 43
- I. Ethernet Patch Cable: 44
- 5.3. CONSTRUCTION METHODS 44
 - A. General: 44
 - B. Edge Switch: 44
- 5.4. MEASUREMENT AND PAYMENT 45

1. SIGNAL HEADS

1.1. MATERIALS

A. General:

Fabricate vehicle signal head housings and end caps from die-cast aluminum. Fabricate 16-inch pedestrian signal head housings and end caps from die-cast aluminum. Provide visor mounting screws, door latches, and hinge pins fabricated from stainless steel. Provide interior screws, fasteners, and metal parts fabricated from stainless steel.

Fabricate tunnel and traditional visors from sheet aluminum.

Paint all surfaces inside and outside of signal housings and doors. Paint outside surfaces of tunnel and traditional visors, wire outlet bodies, wire entrance fitting brackets and end caps when supplied as components of messenger cable mounting assemblies, pole and pedestal mounting assemblies, and pedestrian pushbutton housings. Have electrostatically-applied, fused-polyester paint in highway yellow (Federal Standard 595C, Color Chip Number 13538) a minimum of 2.5 to 3.5 mils thick. Do not apply paint to the latching hardware, rigid vehicle signal head mounting brackets for mast-arm attachments, messenger cable hanger components or balance adjuster components.

Have the interior surfaces of tunnel and traditional visors painted an alkyd urea black synthetic baking enamel with a minimum gloss reflectance and meeting the requirements of MIL-E-10169, "Enamel Heat Resisting, Instrument Black."

Where required, provide polycarbonate signal heads and visors that comply with the provisions pertaining to the aluminum signal heads listed on the QPL with the following exceptions:

Fabricate signal head housings, end caps, and visors from virgin polycarbonate material. Provide UV stabilized polycarbonate plastic with a minimum thickness of 0.1 ± 0.01 inches that is highway yellow (Federal Standard 595C, Color Chip 13538). Ensure the color is incorporated into the plastic material before molding the signal head housings and end caps. Ensure the plastic formulation provides the following physical properties in the assembly (tests may be performed on separately molded specimens):

Test	Required	Method
Specific Gravity	1.17 minimum	ASTM D 792
Flammability	Self-extinguishing	ASTM D 635
Tensile Strength, yield, PSI	8500 minimum	ASTM D 638
Izod impact strength, ft-lb/in [notched, 1/8 inch]	12 minimum	ASTM D 256

For pole mounting, provide side of pole mounting assemblies with framework and all other hardware necessary to make complete, watertight connections of the signal heads to the poles and pedestals. Fabricate the mounting assemblies and frames from aluminum with all necessary hardware, screws, washers, etc. to be stainless steel. Provide mounting fittings that match the positive locking device on the signal head with the serrations integrally cast into the brackets. Provide upper and lower pole plates that have a 1 ¼-inch vertical conduit entrance hubs with the hubs capped on the lower plate and 1 ½-inch horizontal hubs. Ensure that the assemblies provide rigid attachments to poles and pedestals so as to allow no twisting or swaying of the signal heads. Ensure that all raceways are free of sharp edges and protrusions, and can accommodate a minimum of ten Number 14 AWG conductors.

For pedestal mounting, provide a post-top slipfitter mounting assembly that matches the positive locking device on the signal head with serrations integrally cast into the slipfitter. Provide stainless steel hardware, screws, washers, etc. Provide a minimum of six 3/8 X 3/4-inch long square head bolts for attachment to pedestal. Provide a center post for multi-way slipfitters.

For light emitting diode (LED) traffic signal modules, provide the following requirements for inclusion on the Department's Qualified Products List for traffic signal equipment.

1. Sample submittal,
2. Third-party independent laboratory testing results for each submitted module with evidence of testing and conformance with all of the Design Qualification Testing specified in section 6.4 of each of the following Institute of Transportation Engineers (ITE) specifications:
 - Vehicle Traffic Control Signal Heads – Light Emitting Diode (LED) Circular Signal Supplement
 - Vehicle Traffic Control Signal Heads – Light Emitting Diode (LED) Vehicle Arrow Traffic Signal Supplement
 - Pedestrian Traffic Control Signal Indications –Light Emitting Diode (LED) Signal Modules.

(Note: The Department currently recognizes two approved independent testing laboratories. They are Intertek ETL Semko and Light Metrics, Incorporated with Garwood Laboratories. Independent laboratory tests from other laboratories may be considered as part of the QPL submittal at the discretion of the Department,

3. Evidence of conformance with the requirements of these specifications,
4. A manufacturer's warranty statement in accordance with the required warranty, and
5. Submittal of manufacturer's design and production documentation for the model, including but not limited to, electrical schematics, electronic component values, proprietary part numbers, bill of materials, and production electrical and photometric test parameters.
6. Evidence of approval of the product to bear the Intertek ETL Verified product label for LED traffic signal modules.

Ensure LED traffic signal modules meet the performance requirements for the minimum period of 15 years, provide a written warranty against defects in materials and workmanship for the modules for a period of 15 years after installation of the modules. During the warranty period, the manufacturer must provide new replacement modules within 45 days of receipt of modules that have failed at no cost to the State. Repaired or refurbished modules may not be used to fulfill the manufacturer's warranty obligations. Provide manufacturer's warranty documentation to the Department during evaluation of product for inclusion on Qualified Products List (QPL).

B. Vehicle Signal Heads:

Comply with the ITE standard "Vehicle Traffic Control Signal Heads". Provide housings with provisions for attaching backplates.

Provide visors that are 10 inches in length for 12-inch vehicle signal heads.

Provide a termination block with one empty terminal for field wiring for each indication plus one empty terminal for the neutral conductor. Have all signal sections wired to the termination block. Provide barriers between the terminals that have terminal screws with a minimum Number 8 thread size and that will accommodate and secure spade lugs sized for a Number 10 terminal screw.

Mount termination blocks in the yellow signal head sections on all in-line vehicle signal heads. Mount the termination block in the red section on five-section vehicle signal heads.

Furnish vehicle signal head interconnecting brackets. Provide one-piece aluminum brackets less than 4.5 inches in height and with no threaded pipe connections. Provide hand holes on the bottom of the brackets to aid in installing wires to the signal heads. Lower brackets that carry no wires and are used only for connecting the bottom signal sections together may be flat in construction.

For messenger cable mounting, provide messenger cable hangers, wire outlet bodies, balance adjusters, bottom caps, wire entrance fitting brackets, and all other hardware necessary to make complete, watertight connections of the vehicle signal heads to the messenger cable. Fabricate messenger cable hanger components, wire outlet bodies and balance adjuster components from stainless steel or malleable iron galvanized in accordance with ASTM A153 (Class A) or ASTM A123. Provide serrated rings made of aluminum. Provide messenger cable hangers with U-bolt clamps. Fabricate washers, screws, hex-head bolts and associated nuts, clevis pins, cotter pins, U-bolt clamps and nuts from stainless steel.

For mast-arm mounting, provide rigid vehicle signal head mounting brackets and all other hardware necessary to make complete, watertight connections of the vehicle signal heads to the mast arms and to provide a means for vertically adjusting the vehicle signal heads to proper alignment. Fabricate the mounting assemblies from aluminum, and provide serrated rings made of aluminum. Provide stainless steel cable attachment assemblies to secure the brackets to the mast arms. Ensure all fastening hardware and fasteners are fabricated from stainless steel.

Provide LED vehicular traffic signal modules (hereafter referred to as modules) that consist of an assembly that uses LEDs as the light source in lieu of an incandescent lamp for use in traffic signal sections. Use LEDs that are aluminum indium gallium phosphorus (AlInGaP) technology for red and yellow indications and indium gallium nitride (InGaN) for green indications. Install the ultra bright type LEDs that are rated for 100,000 hours of continuous operation from -40°F to +165°F. Design modules to have a minimum useful life of 15 years and to meet all parameters of this specification during this period of useful life.

For the modules, provide spade terminals crimped to the lead wires and sized for a #10 screw connection to the existing terminal block in a standard signal head. Do not provide other types of crimped terminals with a spade adapter.

Ensure the power supply is integral to the module assembly. On the back of the module, permanently mark the date of manufacture (month & year) or some other method of identifying date of manufacture.

Tint the red, yellow and green lenses to correspond with the wavelength (chromaticity) of the LED. Transparent tinting films are unacceptable. Provide a lens that is integral to the unit with a smooth outer surface.

1. LED Circular Signal Modules:

Provide modules in the following configurations: 12-inch circular sections. All makes and models of LED modules purchased for use on the State Highway System shall appear on the current NCDOT Traffic Signal Qualified Products List (QPL).

Provide the manufacturer's model number and the product number (assigned by the Department) for each module that appears on the 2024 or most recent Qualified Products List. In addition, provide manufacturer's certification in accordance with Article 106-3 of the *Standard Specifications*, that each module meets or exceeds the ITE "Vehicle Traffic Control Signal Heads – Light Emitting

Diode (LED) Circular Signal Supplement” dated June 27, 2005 (hereafter referred to as VTCSH Circular Supplement) and other requirements stated in this specification.

Provide modules that meet the following requirements when tested under the procedures outlined in the VTCSH Circular Supplement:

Module Type	Max. Wattage at 165° F	Nominal Wattage at 77° F
12-inch red circular	17	11
12-inch green circular	15	15

For yellow circular signal modules, provide modules tested under the procedures outlined in the VTCSH Circular Supplement to insure power required at 77° F is 22 Watts or less for the 12-inch circular module.

Note: Use a wattmeter having an accuracy of $\pm 1\%$ to measure the nominal wattage and maximum wattage of a circular traffic signal module. Power may also be derived from voltage, current and power factor measurements.

2. LED Arrow Signal Modules

Provide 12-inch omnidirectional arrow signal modules. All makes and models of LED modules purchased for use on the State Highway System shall appear on the current NCDOT Traffic Signal Qualified Products List (QPL).

Provide the manufacturer’s model number and the product number (assigned by the Department) for each module that appears on the 2024 or most recent Qualified Products List. In addition, provide manufacturer’s certification in accordance with Article 106-3 of the *Standard Specifications*, that each module meets or exceeds the requirements for 12-inch omnidirectional modules specified in the ITE “Vehicle Traffic Control Signal Heads – Light Emitting Diode (LED) Vehicle Arrow Traffic Signal Supplement” dated July 1, 2007 (hereafter referred to as VTCSH Arrow Supplement) and other requirements stated in this specification.

Provide modules that meet the following requirements when tested under the procedures outlined in the VTCSH Arrow Supplement:

Module Type	Max. Wattage at 165° F	Nominal Wattage at 77° F
12-inch red arrow	12	9
12-inch green arrow	11	11

For yellow arrow signal modules, provide modules tested under the procedures outlined in the VTCSH Arrow Supplement to insure power required at 77° F is 12 Watts or less.

Note: Use a wattmeter having an accuracy of $\pm 1\%$ to measure the nominal wattage and maximum wattage of an arrow traffic signal module. Power may also be derived from voltage, current and power factor measurements.

C. Pedestrian Signal Heads:

Provide pedestrian signal heads with international symbols that meet the MUTCD. Do not provide letter indications.

Comply with the ITE standard for “Pedestrian Traffic Control Signal Indications” and the following sections of the ITE standard for “Vehicle Traffic Control Signal Heads” in effect on the date of advertisement:

- Section 3.00 - “Physical and Mechanical Requirements”
- Section 4.01 - “Housing, Door, and Visor: General”

- Section 4.04 - “Housing, Door, and Visor: Materials and Fabrication”
- Section 7.00 - “Exterior Finish”

Provide a double-row termination block with three empty terminals and number 10 screws for field wiring. Provide barriers between the terminals that accommodate a spade lug sized for number 10 terminal screws. Mount the termination block in the hand section. Wire all signal sections to the terminal block.

Where required by the plans, provide 16-inch pedestrian signal heads with traditional three-sided, rectangular visors, 6 inches long.

Provide 2-inch diameter pedestrian push-buttons with weather-tight housings fabricated from die-cast aluminum and threading in compliance with the NEC for rigid metal conduit. Provide a weep hole in the housing bottom and ensure that the unit is vandal resistant.

Provide push-button housings that are suitable for mounting on flat or curved surfaces and that will accept 1/2-inch conduit installed in the top. Provide units that have a heavy duty push-button assembly with a sturdy, momentary, normally-open switch. Have contacts that are electrically insulated from the housing and push-button. Ensure that the push-buttons are rated for a minimum of 5 mA at 24 volts DC and 250 mA at 12 volts AC.

Provide standard R10-3 signs with mounting hardware that comply with the MUTCD in effect on the date of advertisement. Provide R10-3E signs for countdown pedestrian heads and R10-3B for non-countdown pedestrian heads.

Design the LED pedestrian traffic signal modules (hereafter referred to as modules) for installation into standard pedestrian traffic signal sections that do not contain the incandescent signal section reflector, lens, eggcrate visor, gasket, or socket. Provide modules that consist of an assembly that uses LEDs as the light source in lieu of an incandescent lamp. Use LEDs that are of the latest aluminum indium gallium phosphorus (AlInGaP) technology for the Portland Orange hand and countdown displays. Use LEDs that are of the latest indium gallium nitride (InGaN) technology for the Lunar White walking man displays. Install the ultra-bright type LEDs that are rated for 100,000 hours of continuous operation from -40°F to +165°F. Design modules to have a minimum useful life of 60 months and to meet all parameters of this specification during this period of useful life.

Design all modules to operate using a standard 3 - wire field installation. Provide spade terminals crimped to the lead wires and sized for a #10 screw connection to the existing terminal block in a standard pedestrian signal housing. Do not provide other types of crimped terminals with a spade adapter.

Ensure the power supply is integral to the module assembly. On the back of the module, permanently mark the date of manufacture (month & year) or some other method of identifying date of manufacture.

Provide modules in the following configuration: 16-inch displays which have the solid hand/walking man overlay on the left and the countdown on the right. All makes and models of LED modules purchased for use on the State Highway System shall appear on the current NCDOT Traffic Signal Qualified Products List (QPL).

Provide the manufacturer’s model number and the product number (assigned by the Department) for each module that appears on the 2024 or most recent Qualified Products List. In addition, provide manufacturer’s certification in accordance with Article 106-3 of the *Standard Specifications*, that each module meets or exceeds the ITE “Pedestrian Traffic Control Signal Indicators - Light Emitting

Diode (LED) Signal Modules” dated August 04, 2010 (hereafter referred to as PTCSI Pedestrian Standard) and other requirements stated in this specification.

Provide modules that meet the following requirements when tested under the procedures outlined in the PTCSI Pedestrian Standard:

Module Type	Max. Wattage at 165° F	Nominal Wattage at 77° F
Hand Indication	16	13
Walking Man Indication	12	9
Countdown Indication	16	13

Note: Use a wattmeter having an accuracy of ±1% to measure the nominal wattage and maximum wattage of a circular traffic signal module. Power may also be derived from voltage, current and power factor measurements.

Provide module lens that is hard coated or otherwise made to comply with the material exposure and weathering effects requirements of the Society of Automotive Engineers (SAE) J576. Ensure all exposed components of the module are suitable for prolonged exposure to the environment, without appreciable degradation that would interfere with function or appearance.

Ensure the countdown display continuously monitors the traffic controller to automatically learn the pedestrian phase time and update for subsequent changes to the pedestrian phase time.

Ensure the countdown display begins normal operation upon the completion of the preemption sequence and no more than one pedestrian clearance cycle.

1.2. CONSTRUCTION METHODS

Modify existing signal heads as shown on the plans. Modifications of the vehicle signal heads shall include installing L.E.D. ARROW displays in the green sections of designated vehicle signal heads. The GREEN ARROW display shall conform to the requirements of section B.2 above for signal modules.

The Contractor, at no additional expense to the Department, may choose at his own discretion to install a new vehicle signal head instead of modifying the existing vehicle signal head. If directed by the Engineer to replace the existing vehicle signal head with a new vehicle signal head instead of modifying the existing vehicle signal head, the Contractor is entitled to full compensation for installation of each new vehicle signal head.

1.3. MEASUREMENT AND PAYMENT

Actual number of each modified signal head display furnished, installed, and accepted.

Payment will be made under:

Modify Existing Vehicle Signal HeadEach

2. CONTROLLERS WITH CABINETS

2.1. MATERIALS – TYPE 2070LX CONTROLLERS

Furnish model 2070LX controller units that conform to CALTRANS *Transportation Electrical Equipment Specifications* (TEES) (dated March 12, 2009, plus Errata 1 dated January 21, 2010 and Errata 2 dated December 5, 2014) except as required herein.

The Department will provide software at the beginning of the burning-in period. Contractor shall give 5 working days notice before needing software. Program software provided by the Department.

Provide model 2070LX controllers with Linux kernel 2.6.18 or higher and device drivers, composed of the unit chassis and at a minimum the following modules and assemblies:

- MODEL 2070-1C, CPU Module, Single Board, with 8Mb Datakey (blue in color)
- MODEL 2070-2E+, Field I/O Module (FI/O)
 - Note: Configure the Field I/O Module to disable both the External WDT Shunt/Toggle Switch and SP3 (SP3 active indicator is “off”)
- MODEL 2070-3B, Front Panel Module (FP), Display B (8x40)
- MODEL 2070-4A, Power Supply Module, 10 AMP

Provide a Board Support Package (BSP) to the state and to any specified applications software manufacturer when requested by the state to facilitate the porting of application software.

2.2. MATERIALS – GENERAL CABINETS

Provide a moisture resistant coating on all circuit boards.

Provide one 20 mm diameter radial lead UL-recognized metal oxide varistor (MOV) between each load switch field terminal and equipment ground. Electrical performance is outlined below.

PROPERTIES OF MOV SURGE PROTECTOR	
Maximum Continuous Applied Voltage at 185° F	150 VAC (RMS) 200 VDC
Maximum Peak 8x20µs Current at 185° F	6500 A
Maximum Energy Rating at 185° F	80 J
Voltage Range 1 mA DC Test at 77° F	212-268 V
Max. Clamping Voltage 8x20µs, 100A at 77° F	395 V
Typical Capacitance (1 MHz) at 77° F	1600 pF

Provide a power line surge protector that is a two-stage device that will allow connection of the radio frequency interference filter between the stages of the device. Ensure that a maximum continuous current is at least 10A at 120V. Ensure that the device can withstand a minimum of 20 peak surge current occurrences at 20,000A for an 8x20 microsecond waveform. Provide a maximum clamp voltage of 395V at 20,000A with a nominal series inductance of 200µh. Ensure that the voltage does not exceed 395V. Provide devices that comply with the following:

Frequency (Hz)	Minimum Insertion Loss (dB)
60	0
10,000	30
50,000	55
100,000	50
500,000	50
2,000,000	60
5,000,000	40
10,000,000	20
20,000,000	25

2.3. MATERIALS – TYPE 170E CABINETS

A. Type 170 E Cabinets General:

Conform to the city of Los Angeles’ Specification No. 54-053-08, *Traffic Signal Cabinet Assembly Specification* (dated July 2008), except as required herein.

Furnish model 332 base mounted cabinets configured for 8 vehicle phases, 4 pedestrian phases, and 6 overlaps. When overlaps are required, provide auxiliary output files for the overlaps. Do not reassign load switches to accommodate overlaps unless shown on electrical details.

Provide model 200 load switches, model 222 loop detector sensors, model 252 AC isolators, and model 242 DC isolators according to the electrical details. As a minimum, provide one (1) model 2018 conflict monitor, one (1) model 206L power supply unit, two (2) model 204 flashers, one (1) DC isolator (located in slot I14), and four (4) model 430 flash transfer relays (provide seven (7) model 430 flash transfer relays if auxiliary output file is installed) with each cabinet.

B. Type 170 E Cabinet Electrical Requirements:

Provide a cabinet assembly designed to ensure that upon leaving any cabinet switch or conflict monitor initiated flashing operation, the controller starts up in the programmed start up phases and start up interval.

Furnish two sets of non-fading cabinet wiring diagrams and schematics in a paper envelope or container and placed in the cabinet drawer.

All AC+ power is subject to radio frequency signal suppression.

Provide surge suppression in the cabinet for each type of cabinet device. Provide surge protection for the full capacity of the cabinet input file. Provide surge suppression devices that operate properly over a temperature range of -40° F to +185° F. Ensure the surge suppression devices provide both common and differential modes of protection.

Provide a pluggable power line surge protector that is installed on the back of the PDA (power distribution assembly) chassis to filter and absorb power line noise and switching transients. Ensure the device incorporates LEDs for failure indication and provides a dry relay contact closure for the purpose of remote sensing. Ensure the device meets the following specifications:

- Peak Surge Current (Single pulse, 8x20µs).....20,000A
- Occurrences (8x20µs waveform).....10 minimum @ 20,000A

- Maximum Clamp Voltage.....395VAC
- Operating Current.....15 amps
- Response Time.....< 5 nanoseconds

Provide a loop surge suppressor for each set of loop terminals in the cabinet. Ensure the device meets the following specifications:

- Peak Surge Current (6 times, 8x20µs)
 - (Differential Mode).....400A
 - (Common Mode).....1,000A
- Occurrences (8x20µs waveform).....500 min @ 200A
- Maximum Clamp Voltage
 - (Differential Mode @400A).....35V
 - (Common Mode @1,000A).....35V
- Response Time.....< 5 nanoseconds
- Maximum Capacitance.....35 pF

Provide a data communications surge suppressor for each communications line entering or leaving the cabinet. Ensure the device meets the following specifications:

- Peak Surge Current (Single pulse, 8x20µs).....10,000A
- Occurrences (8x20µs waveform).....100 min @ 2,000A
- Maximum Clamp Voltage.....Rated for equipment protected
- Response Time.....< 1 nanosecond
- Maximum Capacitance.....1,500 pF
- Maximum Series Resistance.....15Ω

Provide a DC signal surge suppressor for each DC input channel in the cabinet. Ensure the device meets the following specifications:

- Peak Surge Current (Single pulse, 8x20µs).....10,000A
- Occurrences (8x20µs waveform).....100 @ 2,000A
- Maximum Clamp Voltage.....30V
- Response Time.....< 1 nanosecond

Provide a 120 VAC signal surge suppressor for each AC+ interconnect signal input. Ensure the device meets the following specifications:

- Peak Surge Current (Single pulse, 8x20µs).....20,000A
- Maximum Clamp Voltage.....350VAC
- Response Time.....< 200 nanoseconds
- Discharge Voltage.....<200 Volts @ 1,000A
- Insulation Resistance.....≥100 MΩ

Provide conductors for surge protection wiring that are of sufficient size (ampacity) to withstand maximum overcurrents which could occur before protective device thresholds are attained and current flow is interrupted.

If additional surge protected power outlets are needed to accommodate fiber transceivers, modems, etc., install a UL listed, industrial, heavy-duty type power outlet strip with a minimum rating of 15 A / 125 VAC, 60 Hz. Provide a strip that has a minimum of 3 grounded outlets. Ensure the power outlet strip plugs into one of the controller unit receptacles located on the rear of the PDA. Ensure power outlet strip is mounted securely; provide strain relief if necessary.

Provide a door switch in the front and a door switch in the rear of the cabinet that will provide the controller unit with a Door Ajar alarm when either the front or the rear door is open. Ensure the door switches apply DC ground to the Input File when either the front door or the rear door is open.

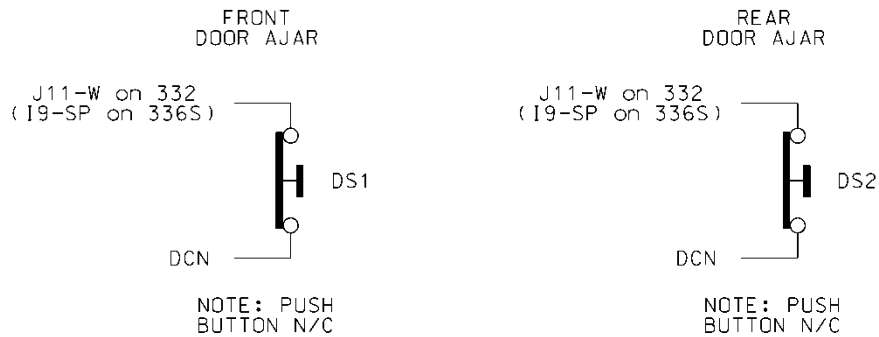

Furnish a fluorescent fixture in the rear across the top of the cabinet and another fluorescent fixture in the front across the top of the cabinet at a minimum. Ensure that the fixtures provide sufficient light to illuminate all terminals, labels, switches, and devices in the cabinet. Conveniently locate the fixtures so as not to interfere with a technician’s ability to perform work on any devices or terminals in the cabinet. Provide a protective diffuser to cover exposed bulbs. Install 16 watt T-4 lamps in the fluorescent fixtures. Provide a door switch to provide power to each fixture when the respective door is open. Wire the fluorescent fixtures to the 15 amp ECB (equipment circuit breaker).

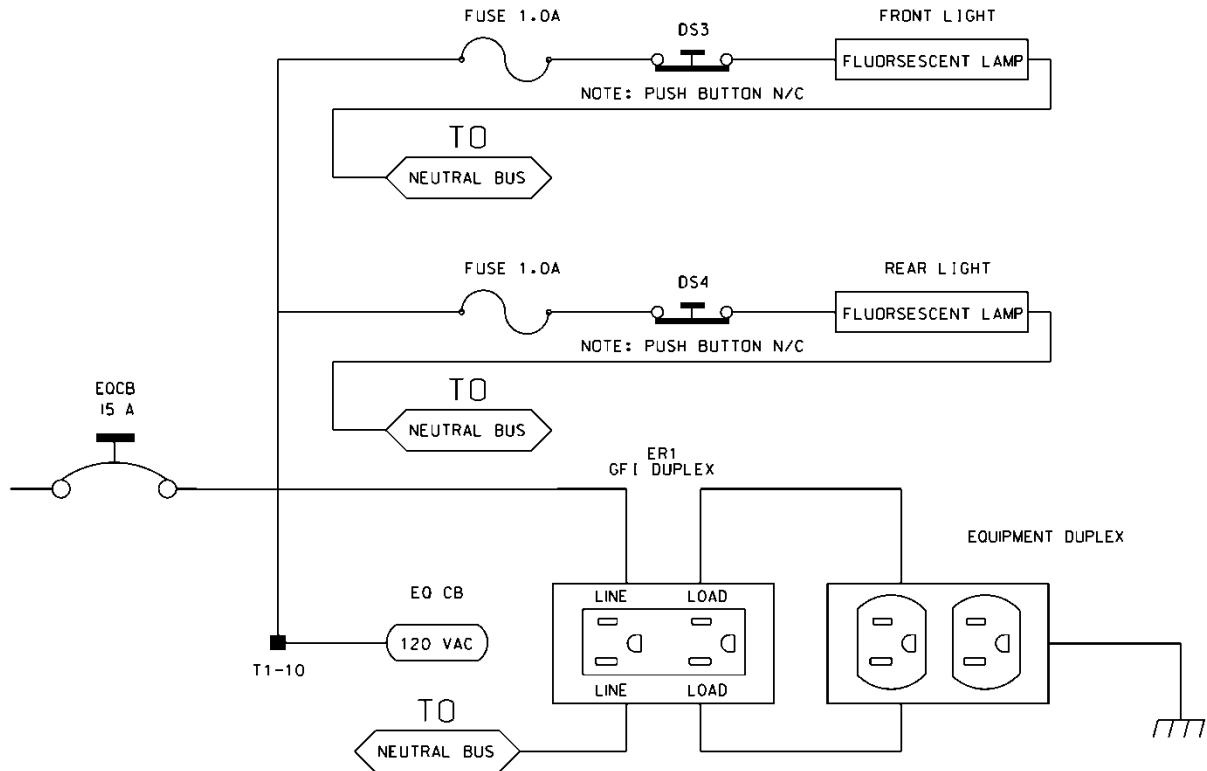

Furnish a police panel with a police panel door. Ensure that the police panel door permits access to the police panel when the main door is closed. Ensure that no rainwater can enter the cabinet even with the police panel door open. Provide a police panel door hinged on the right side as viewed from the front. Provide a police panel door lock that is keyed to a standard police/fire call box key. In addition to the requirements of LA Specification No. 54-053-08, provide the police panel with a toggle switch connected to switch the intersection operation between normal stop-and-go operation (AUTO) and manual operation (MANUAL). Ensure that manual control can be implemented using inputs and software such that the controller provides full programmed clearance times for the yellow clearance and red clearance for each phase while under manual control.

Provide a 1/4-inch locking phone jack in the police panel for a hand control to manually control the intersection. Provide sufficient room in the police panel for storage of a hand control and cord.

For model 332 base mounted cabinets, ensure terminals J14-E and J14-K are wired together on the rear of the Input File. Connect TB9-12 (J14 Common) on the Input Panel to T1-2 (AC-) on the rear of the PDA.

Provide detector test switches mounted at the top of the cabinet rack or other convenient location which may be used to place a call on each of eight phases based on the chart below. Provide three positions for each switch: On (place call), Off (normal detector operation), and Momentary On (place momentary call and return to normal detector operation after switch is released). Ensure that the switches are located such that the technician can read the controller display and observe the intersection.

Connect detector test switches for cabinets as follows:

332 Cabinet	
Detector Call Switches	Terminals
Phase 1	I1-W
Phase 2	I4-W
Phase 3	I5-W
Phase 4	I8-W
Phase 5	J1-W
Phase 6	J4-W
Phase 7	J5-W
Phase 8	J8-W

Provide the PCB 28/56 connector for the conflict monitor unit (CMU) with 28 independent contacts per side, dual-sided with 0.156 inch contact centers. Provide the PCB 28/56 connector contacts with solder eyelet terminations. Ensure all connections to the PCB 28/56 connector are soldered to the solder eyelet terminations.

Ensure that all cabinets have the CMU connector wired according to the 332 cabinet connector pin assignments (include all wires for auxiliary output file connection). Wire pins 13, 16, R, and U of the CMU connector to a separate 4 pin plug, P1, as shown below. Provide a second plug, P2, which will mate with P1 and is wired to the auxiliary output file as shown below. Provide an additional plug, P3, which will mate with P1 and is wired to the pedestrian yellow circuits as shown below. When no auxiliary output file is installed in the cabinet, provide wires for the green and yellow inputs for channels 11, 12, 17, and 18, the red inputs for channels 17 and 18, and the wires for the P2 plug. Terminate the two-foot wires with ring type lugs, insulated, and bundled for optional use.

PIN	P1		P2		P3	
	FUNCTION	CONN TO	FUNCTION	CONN TO	FUNCTION	CONN TO
1	CH-9G	CMU-13	OLA-GRN	A123	2P-YEL	114
2	CH-9Y	CMU-16	OLA-YEL	A122	4P-YEL	105
3	CH-10G	CMU-R	OLB-GRN	A126	6P-YEL	120
4	CH-10Y	CMU-U	OLB-YEL	A125	8P-YEL	111

Do not provide the P20 terminal assembly (red monitor board) or red interface ribbon cable as specified in LA Specification No. 54-053-08.

Provide a P20 connector that mates with and is compatible with the red interface connector mounted on the front of the conflict monitor. Ensure that the P20 connector and the red interface connector on the conflict monitor are center polarized to ensure proper connection. Ensure that removal of the P20 connector will cause the conflict monitor to recognize a latching fault condition and place the cabinet into flashing operation.

Wire the P20 connector to the output file and auxiliary output file using 22 AWG stranded wires. Ensure the length of these wires is a minimum of 42 inches in length. Provide a durable braided sleeve around the wires to organize and protect the wires.

Wire the P20 connector to the traffic signal red displays to provide inputs to the conflict monitor as shown below. Ensure the pedestrian Don't Walk circuits are wired to channels 13 through 16 of the P20 connector. When no auxiliary output file is installed in the cabinet, provide wires for channels 9 through 12 reds. Provide a wire for special function 1. Terminate the unused wires with ring type lugs, insulated, and bundled for optional use.

P20 Connector					
PIN	FUNCTION	CONN TO	PIN	FUNCTION	CONN TO
1	Channel 15 Red	119	2	Channel 16 Red	110
3	Channel 14 Red	104	4	Chassis GND	01-9
5	Channel 13 Red	113	6	N/C	
7	Channel 12 Red	AUX 101	8	Spec Function 1	
9	Channel 10 Red	AUX 124	10	Channel 11 Red	AUX 114
11	Channel 9 Red	AUX 121	12	Channel 8 Red	107
13	Channel 7 Red	122	14	Channel 6 Red	134
15	Channel 5 Red	131	16	Channel 4 Red	101
17	Channel 3 Red	116	18	Channel 2 Red	128
19	Channel 1 Red	125	20	Red Enable	01-14

Ensure the controller unit outputs to the auxiliary output file are pre-wired to the C5 connector. When no auxiliary output file is installed in the cabinet, connect the C5 connector to a storage socket located on the Input Panel or on the rear of the PDA.

Do not wire pin 12 of the load switch sockets.

In addition to the requirements of LA Specification No. 54-053-08, ensure relay K1 on the Power Distribution Assembly (PDA) is a four pole relay and K2 on the PDA is a two pole relay.

Provide a two pole, ganged circuit breaker for the flash bus circuit. Ensure the flash bus circuit breaker is an inverse time circuit breaker rated for 10 amps at 120 VAC with a minimum of 10,000 RMS symmetrical amperes short circuit current rating. Do not provide the auxiliary switch feature on the flash bus circuit breaker. Ensure the ganged flash bus circuit breaker is certified by the circuit breaker manufacturer to provide ganged tripping operation.

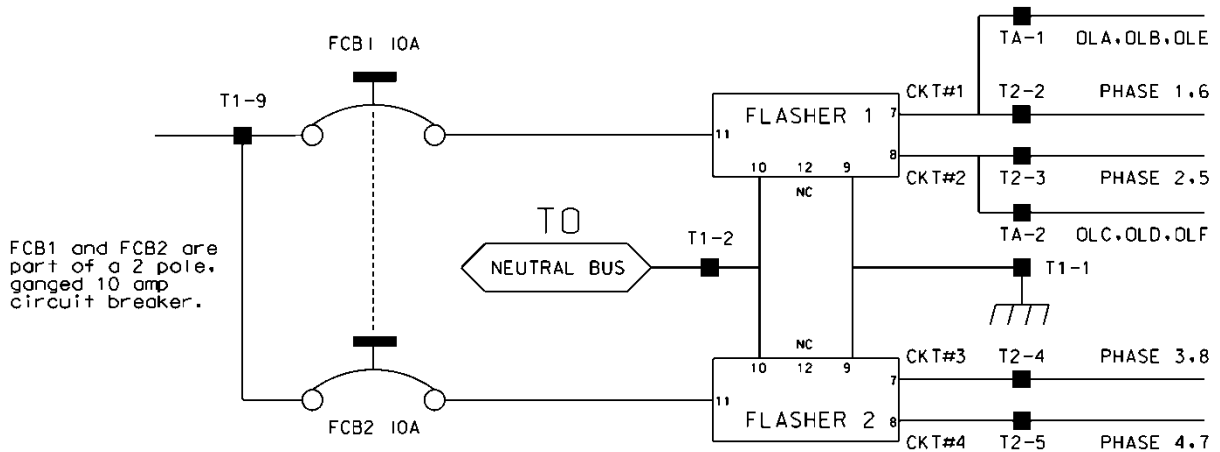

Ensure auxiliary output files are wired as follows:

AUXILIARY OUTPUT FILE TERMINAL BLOCK TA ASSIGNMENTS	
POSITION	FUNCTION
1	Flasher Unit #1, Circuit 1/FTR1 (OLA, OLB)/FTR3 (OLE)
2	Flasher Unit #1, Circuit 2/FTR2 (OLC, OLD)/FTR3 (OLF)
3	Flash Transfer Relay Coils
4	AC -
5	Power Circuit 5
6	Power Circuit 5
7	Equipment Ground Bus
8	NC

Provide four spare load resistors mounted in each cabinet. Ensure each load resistor is rated as shown in the table below. Wire one side of each load resistor to AC-. Connect the other side of each resistor to a separate terminal on a four (4) position terminal block. Mount the load resistors and terminal block either inside the back of Output File No. 1 or on the upper area of the Service Panel.

ACCEPTABLE LOAD RESISTOR VALUES	
VALUE (ohms)	WATTAGE
1.5K – 1.9 K	25W (min)
2.0K – 3.0K	10W (min)

Provide Model 200 load switches, Model 204 flashers, Model 242 DC isolators, Model 252 AC isolators, and Model 206L power supply units that conform to CALTRANS’ “Transportation Electrical Equipment Specifications” dated March 12, 2009 with Erratum 1.

C. Type 170 E Cabinet Physical Requirements:

Do not mold, cast, or scribe the name “City of Los Angeles” on the outside of the cabinet door as specified in LA Specification No. 54-053-08. Do not provide a Communications Terminal Panel as specified in LA Specification No. 54-053-08. Do not provide terminal block TBB on the Service Panel. Do not provide Cabinet Verification Test Program software or associated test jigs as specified in LA Specification No. 54-053-08.

Furnish unpainted, natural, aluminum cabinet shells. Ensure that all non-aluminum hardware on the cabinet is stainless steel or a Department approved non-corrosive alternate.

Ensure the lifting eyes, gasket channels, police panel, and all supports welded to the enclosure and doors are fabricated from 0.125 inch minimum thickness aluminum sheet and meet the same standards as the cabinet and doors.

Provide front and rear doors with latching handles that allow padlocking in the closed position. Furnish 0.75 inch minimum diameter stainless steel handles with a minimum 0.5 inch shank. Place the padlocking attachment at 4.0 inches from the handle shank center to clear the lock and key. Provide an additional 4.0 inches minimum gripping length.

Provide Corbin #2 locks on the front and rear doors. Provide one (1) Corbin #2 and one (1) police master key with each cabinet. Ensure main door locks allow removal of keys in the locked position only.

Provide a surge protection panel with 16 loop surge protection devices and designed to allow sufficient free space for wire connection/disconnection and surge protection device replacement. For model 332 cabinets, provide an additional 20 loop surge protection devices. Provide an additional two AC+ interconnect surge devices to protect one slot and eight DC surge protection devices to protect four slots. Provide no protection devices on slot I14.

For base mounted cabinets, mount surge protection panels on the left side of the cabinet as viewed from the rear. Attach each panel to the cabinet rack assembly using bolts and make it easily removable. Mount the surge protection devices in vertical rows on each panel and connect the devices to one side of 12 position, double row terminal blocks with #8 screws. For each surge protection panel, terminate all grounds from the surge protection devices on a copper equipment ground bus attached to the surge protection panel. Wire the terminals to the rear of a standard input file using spade lugs for input file protection.

Provide permanent labels that indicate the slot and the pins connected to each terminal that may be viewed from the rear cabinet door. Label and orient terminals so that each pair of inputs is next to each other. Indicate on the labeling the input file (I or J), the slot number (1-14) and the terminal pins of the input slots (either D & E for upper or J & K for lower).

Provide a minimum 14 x 16 inch pull out, hinged top shelf located immediately below controller mounting section of the cabinet. Ensure the shelf is designed to fully expose the table surface outside the controller at a height approximately even with the bottom of the controller. Ensure the shelf has a storage bin interior which is a minimum of 1 inch deep and approximately the same dimensions as the shelf. Provide an access to the storage area by lifting the hinged top of the shelf. Fabricate the shelf and slide from aluminum or stainless steel and ensure the assembly can support the 2070L controller plus 15 pounds of additional weight. Ensure shelf has a locking mechanism to secure it in the fully extended position and does not inhibit the removal of the 2070L controller or removal of cards inside the controller when fully extended. Provide a locking mechanism that is easily released when the shelf is to be returned to its non-use position directly under the controller.

D. Model 2018 Enhanced Conflict Monitor:

Furnish Model 2018 Enhanced Conflict Monitors that provide monitoring of 18 channels. Ensure each channel consists of a green, yellow, and red field signal input. Ensure that the conflict monitor meets or exceeds CALTRANS' Transportation Electrical Equipment Specifications dated March 12, 2009, with Erratum 1 (hereafter referred to as CALTRANS' 2009 TEES) for a model 210 monitor unit and other requirements stated in this specification.

Ensure the conflict monitor is provided with an 18 channel conflict programming card. Pin EE and Pin T of the conflict programming card shall be connected together. Pin 16 of the conflict programming card shall be floating. Ensure that the absence of the conflict programming card will cause the conflict monitor to trigger (enter into fault mode), and remain in the triggered state until the programming card is properly inserted and the conflict monitor is reset.

Provide a conflict monitor that incorporates LED indicators into the front panel to dynamically display the status of the monitor under normal conditions and to provide a comprehensive review of field inputs with monitor status under fault conditions. Ensure that the monitor indicates the channels that were active during a conflict condition and the channels that experienced a failure for all other per channel fault conditions detected. Ensure that these indications and the status of each channel are retained until the Conflict Monitor is reset. Furnish LED indicators for the following:

- AC Power (Green LED indicator)
- VDC Failed (Red LED indicator)
- WDT Error (Red LED indicator)
- Conflict (Red LED indicator)
- Red Fail (Red LED indicator)
- Dual Indication (Red LED indicator)
- Yellow/Clearance Failure (Red LED indicator)
- PCA/PC Ajar (Red LED indicator)
- Monitor Fail/Diagnostic Failure (Red LED indicator)
- 54 Channel Status Indicators (1 Red, 1 Yellow, and 1 Green LED indicator for each of the 18 channels)

Provide a switch to set the Red Fail fault timing. Ensure that when the switch is in the ON position the Red Fail fault timing value is set to 1350 +/- 150 ms (2018 mode). Ensure that when the switch is in the OFF position the Red Fail fault timing value is set to 850 +/- 150 ms (210 mode).

Provide a switch to set the Watchdog fault timing. Ensure that when the switch is in the ON position the Watchdog fault timing value is set to 1.0 +/- 0.1 s (2018 mode). Ensure that when the switch is in the OFF position the Watchdog fault timing value is set to 1.5 +/- 0.1 s (210 mode).

Provide a jumper or switch to set the AC line brown-out levels. Ensure that when the jumper is present or the switch is in the ON position the AC line dropout voltage threshold is 98 +/- 2 Vrms, the AC line restore voltage threshold is 103 +/- 2 Vrms, and the AC line brown-out timing value is set to 400 +/- 50ms (2018 mode). Ensure that when the jumper is not present or the switch is in the OFF position the AC line dropout voltage threshold is 92 +/- 2 Vrms, the AC line restore voltage threshold is 98 +/- 2 Vrms, and the AC line brown-out timing value is set to 80 +/- 17 ms (210 mode).

Provide a jumper or switch that will enable and disable the Watchdog Latch function. Ensure that when the jumper is not present or the switch is in the OFF position the Watchdog Latch function

is disabled. In this mode of operation, a Watchdog fault will be reset following a power loss, brownout, or power interruption. Ensure that when the jumper is present or the switch is in the ON position the Watchdog Latch function is enabled. In this mode of operation, a Watchdog fault will be retained until a Reset command is issued.

Provide a jumper that will reverse the active polarity for pin #EE (output relay common). Ensure that when the jumper is not present pin #EE (output relay common) will be considered 'Active' at a voltage greater than 70 Vrms and 'Not Active' at a voltage less than 50 Vrms (Caltrans mode). Ensure that when the jumper is present pin #EE (output relay common) will be considered 'Active' at a voltage less than 50 Vrms and 'Not Active' at a voltage greater than 70 Vrms (Failsafe mode).

In addition to the connectors required by CALTRANS' 2009 TEES, provide the conflict monitor with a red interface connector mounted on the front of the monitor. Ensure the connector is a 20 pin, right angle, center polarized, male connector with latching clip locks and polarizing keys. Ensure the right angle solder tails are designed for a 0.062" thick printed circuit board. Keying of the connector shall be between pins 3 and 5, and between 17 and 19. Ensure the connector has two rows of pins with the odd numbered pins on one row and the even pins on the other row. Ensure the connector pin row spacing is 0.10" and pitch is 0.10". Ensure the mating length of the connector pins is 0.24". Ensure the pins are finished with gold plating 30μ" thick.

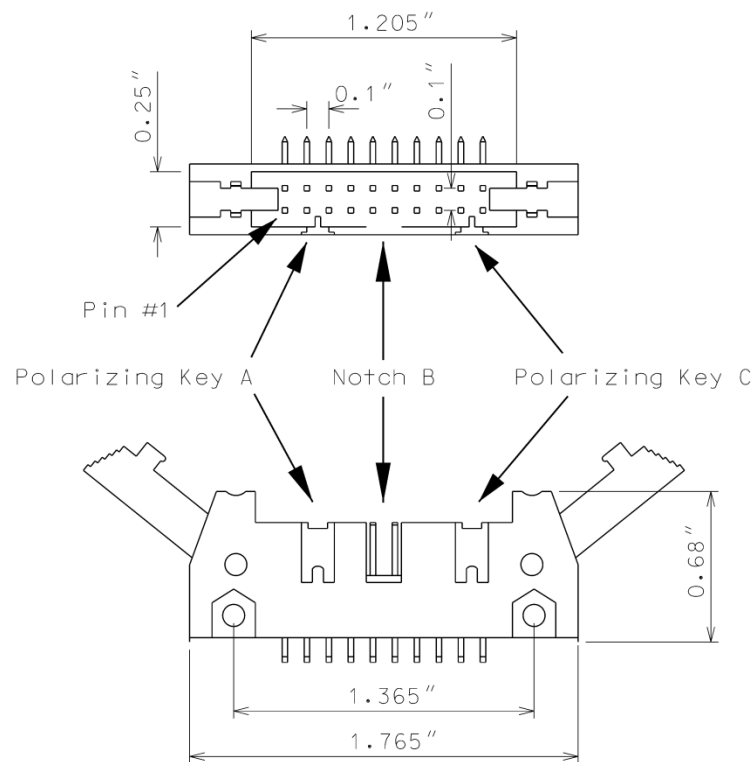

Ensure the red interface connector pins on the monitor have the following functions:

Pin #	Function	Pin #	Function
1	Channel 15 Red	2	Channel 16 Red
3	Channel 14 Red	4	Chassis Ground
5	Channel 13 Red	6	Special Function 2
7	Channel 12 Red	8	Special Function 1
9	Channel 10 Red	10	Channel 11 Red
11	Channel 9 Red	12	Channel 8 Red
13	Channel 7 Red	14	Channel 6 Red
15	Channel 5 Red	16	Channel 4 Red
17	Channel 3 Red	18	Channel 2 Red
19	Channel 1 Red	20	Red Enable

Ensure that removal of the P20 cable connector will cause the conflict monitor to recognize a latching fault condition and place the cabinet into flashing operation.

Provide Special Function 1 and Special Function 2 inputs to the unit which shall disable only Red Fail Monitoring when either input is sensed active. A Special Function input shall be sensed active when the input voltage exceeds 70 Vrms with a minimum duration of 550 ms. A Special Function input shall be sensed not active when the input voltage is less than 50 Vrms or the duration is less than 250 ms. A Special Function input is undefined by these specifications and may or may not be sensed active when the input voltage is between 50 Vrms and 70 Vrms or the duration is between 250 ms and 550 ms.

Ensure the conflict monitor recognizes field signal inputs for each channel that meet the following requirements:

- consider a Red input greater than 70 Vrms and with a duration of at least 500 ms as an “on” condition;
- consider a Red input less than 50 Vrms or with a duration of less than 200 ms as an “off” condition (no valid signal);
- consider a Red input between 50 Vrms and 70 Vrms or with a duration between 200 ms and 500 ms to be undefined by these specifications;
- consider a Green or Yellow input greater than 25 Vrms and with a duration of at least 500 ms as an “on” condition;
- consider a Green or Yellow input less than 15 Vrms or with a duration of less than 200 ms as an “off” condition; and
- consider a Green or Yellow input between 15 Vrms and 25 Vrms or with a duration between 200 ms and 500 ms to be undefined by these specifications.

Provide a conflict monitor that recognizes the faults specified by CALTRANS’ 2009 TEES and the following additional faults. Ensure the conflict monitor will trigger upon detection of a fault and will remain in the triggered (in fault mode) state until the unit is reset at the front panel or through the external remote reset input for the following failures:

1. **Red Monitoring or Absence of Any Indication (Red Failure):** A condition in which no “on” voltage signal is detected on any of the green, yellow, or red inputs to a given monitor channel. If a signal is not detected on at least one input (R, Y, or G) of a conflict monitor

channel for a period greater than 1000 ms when used with a 170 controller and 1500 ms when used with a 2070 controller, ensure monitor will trigger and put the intersection into flash. If the absence of any indication condition lasts less than 700 ms when used with a 170 controller and 1200 ms when used with a 2070 controller, ensure conflict monitor will not trigger. Red fail monitoring shall be enabled on a per channel basis by the use of switches located on the conflict monitor. Have red monitoring occur when all of the following input conditions are in effect:

- a) Red Enable input to monitor is active (Red Enable voltages are “on” at greater than 70 Vrms, off at less than 50 Vrms, undefined between 50 and 70 Vrms), and
 - b) Neither Special Function 1 nor Special Function 2 inputs are active.
 - c) Pin #EE (output relay common) is not active
2. **Short/Missing Yellow Indication Fault (Clearance Error):** Yellow indication following a green is missing or shorter than 2.7 seconds (with ± 0.1 -second accuracy). If a channel fails to detect an “on” signal at the Yellow input for a minimum of 2.7 seconds (± 0.1 second) following the detection of an “on” signal at a Green input for that channel, ensure that the monitor triggers and generates a clearance/short yellow error fault indication. Short/missing yellow (clearance) monitoring shall be enabled on a per channel basis by the use of switches located on the conflict monitor. This fault shall not occur when the channel is programmed for Yellow Inhibit, when the Red Enable signal is inactive or pin #EE (output relay common) is active.
 3. **Dual Indications on the Same Channel:** In this condition, more than one indication (R,Y,G) is detected as “on” at the same time on the same channel. If dual indications are detected for a period greater than 500 ms, ensure that the conflict monitor triggers and displays the proper failure indication (Dual Ind fault). If this condition is detected for less than 200 ms, ensure that the monitor does not trigger. G-Y-R dual indication monitoring shall be enabled on a per channel basis by the use of switches located on the conflict monitor. G-Y dual indication monitoring shall be enabled for all channels by use of a switch located on the conflict monitor. This fault shall not occur when the Red Enable signal is inactive or pin #EE (output relay common) is active.
 4. **Configuration Settings Change:** The configuration settings are comprised of (as a minimum) the permissive diode matrix, dual indication switches, yellow disable jumpers, any option switches, any option jumpers, and the Watchdog Enable switch. Ensure the conflict monitor compares the current configuration settings with the previous stored configuration settings on power-up, on reset, and periodically during operation. If any of the configuration settings are changed, ensure that the conflict monitor triggers and causes the program card indicator to flash. Ensure that configuration change faults are only reset by depressing and holding the front panel reset button for a minimum of three seconds. Ensure the external remote reset input does not reset configuration change faults.

Ensure the conflict monitor will trigger and the AC Power indicator will flash at a rate of 2 Hz \pm 20% with a 50% duty cycle when the AC Line voltage falls below the “drop-out” level. Ensure the conflict monitor will resume normal operation when the AC Line voltage returns above the “restore” level. Ensure the AC Power indicator will remain illuminated when the AC voltage returns above the “restore” level. Should an AC Line power interruption occur while the monitor is in the fault mode, then upon restoration of AC Line power, the monitor will remain in the fault mode and the correct fault and channel indicators will be displayed.

Provide a flash interval of at least 6 seconds and at most 16 seconds in duration following a power-up, an AC Line interruption, or a brownout restore. Ensure the conflict monitor will suspend all fault monitoring functions, close the Output relay contacts, and flash the AC indicator at a rate of 4 Hz ± 20% with a 50% duty cycle during this interval. Ensure the termination of the flash interval after at least 6 seconds if the Watchdog input has made 5 transitions between the True and False state and the AC Line voltage is greater than the “restore” level. If the watchdog input has not made 5 transitions between the True and False state within 10 ± 0.5 seconds, the monitor shall enter a WDT error fault condition.

Ensure the conflict monitor will monitor an intersection with a minimum of four approaches using the four-section Flashing Yellow Arrow (FYA) vehicle traffic signal as outlined by the NCHRP 3-54 research project for protected-permissive left turn signal displays. Ensure the conflict monitor will operate in the FYA mode and FYAc (Compact) mode as specified below to monitor each channel pair for the following fault conditions: Conflict, Flash Rate Detection, Red Fail, Dual Indication, and Clearance. Provide a switch to select between the FYA mode and FYAc mode. Provide a switch to select each FYA phase movement for monitoring.

FYA mode

FYA Signal Head	Phase 1	Phase 3	Phase 5	Phase 7
Red Arrow	Channel 9 Red	Channel 10 Red	Channel 11 Red	Channel 12 Red
Yellow Arrow	Channel 9 Yellow	Channel 10 Yellow	Channel 11 Yellow	Channel 12 Yellow
Flashing Yellow Arrow	Channel 9 Green	Channel 10 Green	Channel 11 Green	Channel 12 Green
Green Arrow	Channel 1 Green	Channel 3 Green	Channel 5 Green	Channel 7 Green

If a FYA channel pair is enabled for FYA operation, the conflict monitor will monitor the FYA logical channel pair for the additional following conditions:

1. **Conflict:** Channel conflicts are detected based on the permissive programming jumpers on the program card. This operation remains unchanged from normal operation except for the solid Yellow arrow (FYA clearance) signal.
2. **Yellow Change Interval Conflict:** During the Yellow change interval of the Permissive Turn channel (flashing Yellow arrow) the conflict monitor shall verify that no conflicting channels to the solid Yellow arrow channel (clearance) are active. These conflicting channels shall be determined by the program card compatibility programming of the Permissive Turn channel (flashing Yellow arrow). During the Yellow change interval of the Protected Turn channel (solid Green arrow) the conflict monitor shall verify that no conflicting channels to the solid Yellow arrow channel (clearance) are active as determined by the program card compatibility programming of the Protected Turn channel (solid Green arrow).

3. **Flash Rate Detection:** The conflict monitor unit shall monitor for the absence of a valid flash rate for the Permissive turn channel (flashing Yellow arrow). If the Permissive turn channel (flashing Yellow arrow) is active for a period greater than 1600 milliseconds, ensure the conflict monitor triggers and puts the intersection into flash. If the Permissive turn channel (flashing Yellow arrow) is active for a period less than 1400 milliseconds, ensure the conflict monitor does not trigger. Ensure the conflict monitor will remain in the triggered (in fault mode) state until the unit is reset at the front panel or through the external remote reset input. Provide a jumper or switch that will enable and disable the Flash Rate Detection function. Ensure that when the jumper is not present or the switch is in the OFF position the Flash Rate Detection function is enabled. Ensure that when the jumper is present or the switch is in the ON position the Flash Rate Detection function is disabled.
4. **Red Monitoring or Absence of Any Indication (Red Failure):** The conflict monitor unit shall detect a red failure if there is an absence of voltage on all four of the inputs of a FYA channel pair (RA, YA, FYA, GA).
5. **Dual Indications on the Same Channel:** The conflict monitor unit shall detect a dual indication if two or more inputs of a FYA channel pair (RA, YA, FYA, GA) are “on” at the same time.
6. **Short/Missing Yellow Indication Fault (Clearance Error):** The conflict monitor unit shall monitor the solid Yellow arrow for a clearance fault when terminating both the Protected Turn channel (solid Green arrow) interval and the Permissive Turn channel (flashing Yellow arrow) interval.

Ensure that the conflict monitor will log at least nine of the most recent events detected by the monitor in non-volatile EEPROM memory (or equivalent). For each event, record at a minimum the time, date, type of event, status of each field signal indication with RMS voltage, and specific channels involved with the event. Ensure the conflict monitor will log the following events: monitor reset, configuration, previous fault, and AC line. Furnish the signal sequence log that shows all channel states (Greens, Yellows, and Reds) and the Red Enable State for a minimum of 2 seconds prior to the current fault trigger point. Ensure the display resolution of the inputs for the signal sequence log is not greater than 50 ms.

For conflict monitors used within an Ethernet communications system, provide a conflict monitor with an Ethernet 10/100 Mbps, RJ-45 port for data communication access to the monitor by a local notebook computer and remotely via a workstation or notebook computer device connected to the signal system local area network. The Ethernet port shall be electrically isolated from the conflict monitor’s electronics and shall provide a minimum of 1500 Vrms isolation. Integrate monitor with Ethernet network in cabinet. Provide software to retrieve the time and date from a network server in order to synchronize the on-board times between the conflict monitor and the controller. Furnish and install the following Windows based, graphic user interface software on workstations and notebook computers where the signal system client software is installed: 1) software to view and retrieve all event log information, 2) software that will search and display a list of conflict monitor IP addresses and IDs on the network, and 3) software to change the conflict monitor’s network parameters such as IP address and subnet mask.

For non-Ethernet connected monitors, provide a RS-232C/D compliant port (DB-9 female connector) on the front panel of the conflict monitor in order to provide communications from the conflict monitor to the 170/2070 controller or to a Department-furnished laptop computer. Electrically isolate the port interface electronics from all monitor electronics, excluding Chassis Ground. Ensure that the controller can receive all event log information through a controller

Asynchronous Communications Interface Adapter (Type 170E) or Async Serial Comm Module (2070). Furnish and connect a serial cable from the conflict monitor's DB-9 connector to Comm Port 1 of the 2070 controller. Ensure conflict monitor communicates with the controller. Provide a Windows based graphic user interface software to communicate directly through the same monitor RS-232C/D compliant port to retrieve and view all event log information to a Department-furnished laptop computer. The RS-232C/D compliant port on the monitor shall allow the monitor to function as a DCE device with pin connections as follows:

Conflict Monitor RS-232C/D (DB-9 Female) Pinout		
Pin Number	Function	I/O
1	DCD	O
2	TX Data	O
3	RX Data	I
4	DTR	I
5	Ground	-
6	DSR	O
7	CTS	I
8	RTS	O
9	NC	-

MONITOR BOARD EDGE CONNECTOR

Pin #	Function (Back Side)	Pin #	Function (Component Side)
1	Channel 2 Green	A	Channel 2 Yellow
2	Channel 13 Green	B	Channel 6 Green
3	Channel 6 Yellow	C	Channel 15 Green
4	Channel 4 Green	D	Channel 4 Yellow
5	Channel 14 Green	E	Channel 8 Green
6	Channel 8 Yellow	F	Channel 16 Green
7	Channel 5 Green	H	Channel 5 Yellow
8	Channel 13 Yellow	J	Channel 1 Green
9	Channel 1 Yellow	K	Channel 15 Yellow
10	Channel 7 Green	L	Channel 7 Yellow
11	Channel 14 Yellow	M	Channel 3 Green
12	Channel 3 Yellow	N	Channel 16 Yellow
13	Channel 9 Green	P	Channel 17 Yellow
14	Channel 17 Green	R	Channel 10 Green
15	Channel 11 Yellow	S	Channel 11 Green
16	Channel 9 Yellow	T	Channel 18 Yellow
17	Channel 18 Green	U	Channel 10 Yellow
--		--	
18	Channel 12 Yellow	V	Channel 12 Green
19	Channel 17 Red	W	Channel 18 Red
20	Chassis Ground	X	Not Assigned
21	AC-	Y	DC Common
22	Watchdog Timer	Z	External Test Reset
23	+24VDC	AA	+24VDC
24	Tied to Pin 25	BB	Stop Time (Output)
25	Tied to Pin 24	CC	Not Assigned
26	Not Assigned	DD	Not Assigned
27	Relay Output, Side #3, N.O.	EE	Relay Output, Side #2, Common
28	Relay Output, Side #1, N.C.	FF	AC+

-- Slotted for keying between Pins 17/U and 18/V

CONFLICT PROGRAM CARD PIN ASSIGNMENTS

Pin #	Function (Back Side)	Pin #	Function (Component Side)
1	Channel 2 Green	A	Channel 1 Green
2	Channel 3 Green	B	Channel 2 Green
3	Channel 4 Green	C	Channel 3 Green
4	Channel 5 Green	D	Channel 4 Green
5	Channel 6 Green	E	Channel 5 Green
6	Channel 7 Green	F	Channel 6 Green
7	Channel 8 Green	H	Channel 7 Green
8	Channel 9 Green	J	Channel 8 Green
9	Channel 10 Green	K	Channel 9 Green
10	Channel 11 Green	L	Channel 10 Green
11	Channel 12 Green	M	Channel 11 Green
12	Channel 13 Green	N	Channel 12 Green
13	Channel 14 Green	P	Channel 13 Green
14	Channel 15 Green	R	Channel 14 Green
15	Channel 16 Green	S	Channel 15 Green
16	N/C	T	PC AJAR
17	Channel 1 Yellow	U	Channel 9 Yellow
18	Channel 2 Yellow	V	Channel 10 Yellow
19	Channel 3 Yellow	W	Channel 11 Yellow
20	Channel 4 Yellow	X	Channel 12 Yellow
21	Channel 5 Yellow	Y	Channel 13 Yellow
22	Channel 6 Yellow	Z	Channel 14 Yellow
23	Channel 7 Yellow	AA	Channel 15 Yellow
24	Channel 8 Yellow	BB	Channel 16 Yellow
--		--	
25	Channel 17 Green	CC	Channel 17 Yellow
26	Channel 18 Green	DD	Channel 18 Yellow
27	Channel 16 Green	EE	PC AJAR (Program Card)
28	Yellow Inhibit Common	FF	Channel 17 Green

-- Slotted for keying between Pins 24/BB and 25/CC

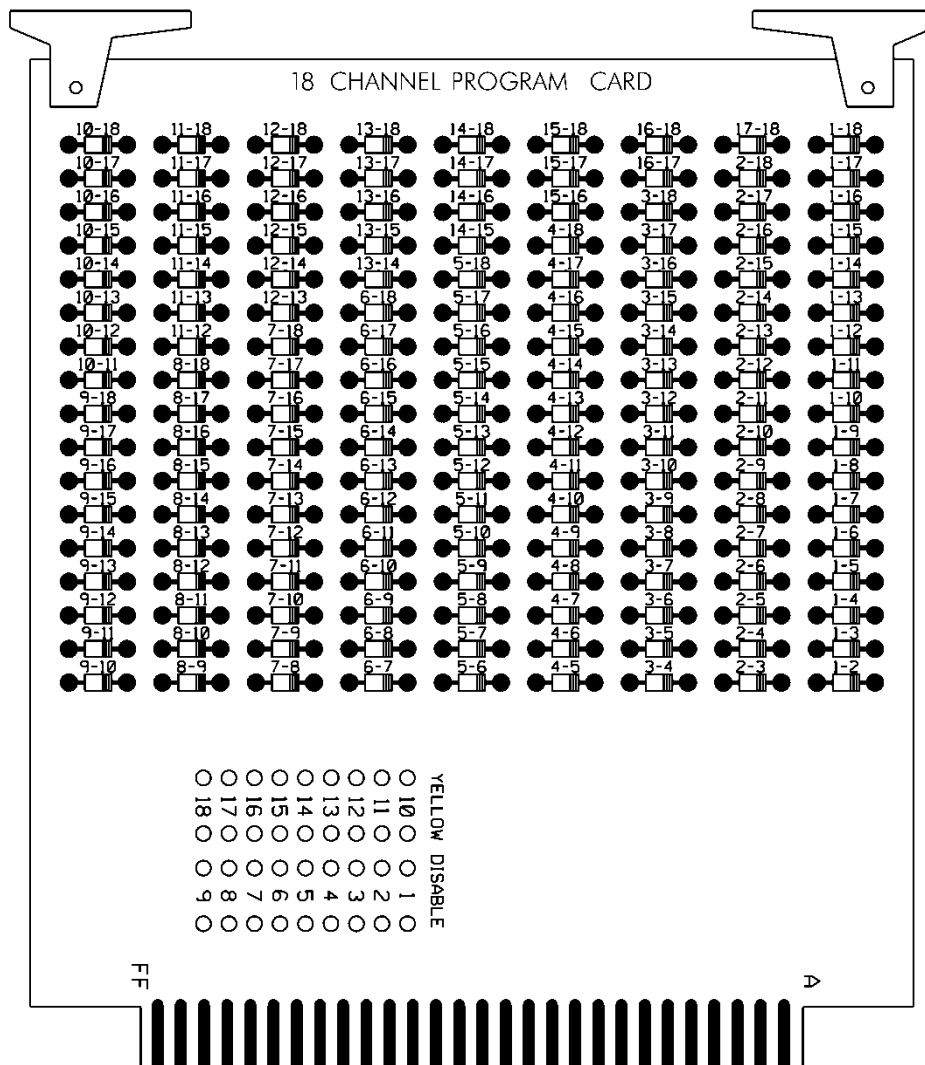

2.4. MATERIALS – TYPE 170 DETECTOR SENSOR UNITS

Furnish detector sensor units that comply with Chapter 5 Section 1, “General Requirements,” and Chapter 5 Section 2, “Model 222 & 224 Loop Detector Sensor Unit Requirements,” of the CALTRANS “Transportation Electrical Equipment Specifications” dated March 12, 2009 with Erratum 1.

3. MICROWAVE VEHICLE DETECTION SYSTEM - MULTIPLE DETECTION ZONES

3.1. DESCRIPTION

Design, furnish and install a microwave vehicle detection system with the manufacturer recommended cables and hardware in accordance to the plans and specifications. Ensure the detection system provides multiple detection zones.

3.2. MATERIALS

Provide design drawings showing design details and microwave sensor locations for review and acceptance before installation. Provide mounting height and location requirements for microwave sensor units on the design based on a site survey. Design microwave vehicle detection system with all necessary hardware. Indicate all necessary poles, spans, mast arms, luminaire arms, cables,

microwave sensor mounting assemblies and hardware to achieve the required detection zones where Department owned poles are not adequate to locate the microwave sensor units. Do not design for the installation of poles in medians.

Obtain the Engineer's approval before furnishing microwave vehicle detection system. The contractor is responsible for the final design of microwave vehicle detection system. Review and acceptance of the designs by the Department does not relieve the contractor from the responsibility to provide fully functional systems and to ensure that the required detection zones can be provided. With the exception of contractor-furnished poles, mast arms, and luminaire arms, furnish material, equipment, and hardware under this section that is pre-approved on the ITS and Signals QPL. Submit and obtain Engineer's approval of shop drawings for any poles, mast arms, and luminaire arms provided by the contractor prior to ordering from manufacturer.

Provide a detector for either side-fire or forward-fire configuration. Ensure the detector will detect vehicles in sunny, cloudy, rainy, snowy, and foggy weather conditions. Ensure the detector can operate from the voltage supplied by a NEMA TS-1/TS-2 or Type 332 or 336 traffic signal cabinet. Ensure the detector can provide detection calls to the traffic signal controller within a NEMA TS-1/TS-2 or Type 332 or 336 cabinet. Ensure the detection system provides a constant call in the event of a component failure or loss of power. Ensure the detector has an operating temperature range of -30 to 165 degrees F and operates within the frequency range of 10 to 25 GHz. Ensure the detector is provided with a water-tight housing offering NEMA 4X protection and operates properly in up to 95% relative humidity, non-condensing.

Provide each detector unit to allow the placement of at least 8 detection zones with a minimum of 8 detection channel outputs. When the microwave vehicle detection system requires an integrated card rack interface(s), provide only enough interface cards to implement the vehicle detection shown on the signal plans. Provide a means acceptable to the Engineer to configure traffic lanes and detection zones. Provide each channel output with a programmable means to delay the output call upon activation of a detection zone that is adjustable in one second increments (maximum) over the range of 0 to 25 seconds. Provide each channel output with a programmable means to extend the output call that is adjustable in one second increments (maximum) over the range of 0 to 25 seconds. Ensure both delay and extend timing can be set for the same channel output.

For advance detection system, ensure the detector senses vehicles in motion at a range of 50 to 400 feet from the detector unit for forward-fire configuration and a range of 50 to 200 feet from the detector unit for side-fire configuration with an accuracy of 95% for both configurations. Ensure the advance detection system provides each channel output call of at least 100 ms in duration.

For stop bar presence detection system, ensure the detector outputs a constant call while a vehicle is in the detection zone and removes the call after all vehicles exit the detection zone. Ensure the presence detector unit can cover a detection zone as shown on the plans and has an effective range of 10 to 120 feet from the detector unit.

For units without an integrated card rack interface, provide Form C output relay contacts rated a minimum of 3A, 24VDC.

If a laptop is used to adjust detector settings, ensure that software is licensed for use by the Department and by any other agency responsible for maintaining or operating the microwave detection system. Provide the Department with a license to duplicate and distribute the software as necessary for design and maintenance support.

After initial detector configuration and installation, ensure routine adjustments or calibration are not needed to maintain acceptable performance.

3.3. CONSTRUCTION METHODS

Install the microwave vehicle detection system in accordance with the manufacturer’s recommendations.

Monitor and maintain each detector unit during construction to ensure microwave vehicle detection system is functioning properly and aimed for the detection zone shown in the plans. Refer to Subarticle 1700-3 (D) Maintenance and Repair of Materials of the *Standard Specifications* for failure to maintain the microwave detection system.

3.4. MEASUREMENT AND PAYMENT

Actual number of microwave vehicle detection systems – multiple zones furnished, installed, and accepted.

No measurement will be made of cables or hardware, as these will be considered incidental to furnishing and installing microwave vehicle detection systems.

Payment will be made under:

Microwave Vehicle Detection System – Multiple Zones Each

4. METAL POLE SUPPORTS

4.1. METAL POLES

A. General:

Furnish and install metal poles, grounding systems, and all necessary hardware. Work covered under this special provision includes requirements for design, fabrication, and installation of standard and custom/site-specific designed metal pole supports and associated foundations.

Comply with applicable sections of the 2024 STANDARD SPECIFICATIONS FOR ROADS & STRUCTURES, hereinafter referred to as the *Standard Specifications*. Provide designs of completed assemblies with hardware equaling or exceeding AASHTO LRFD Specifications for Structural Supports for Highway Signs, Luminaires and Traffic Signals 1st Edition, 2015 (hereinafter called 1st Edition AASHTO), including the latest interim specifications. Provide assemblies with a round or near-round (18 sides or more) cross-section, or a multi-sided cross section with no less than six sides. The sides may be straight, convex, or concave.

For bid purposes, pole heights shown on plans are estimated from available data. Prior to furnishing metal poles, use field measurements and adjusted cross-sections to determine whether pole heights will meet required clearances. If pole heights do not meet required clearances, the Contractor should immediately notify the Engineer of the required revised pole heights.

Standard Drawings for Metal Poles are available that supplement these project special provisions. The drawings are located on the Department’s website:

<https://connect.ncdot.gov/resources/safety/pages/ITS-Design-Resources.aspx>

Comply with article 1098-1(B) of the *Standard Specifications* for submittal requirements. Furnish shop drawings for approval. Provide copies of detailed shop drawings for each type of structure as summarized below. Ensure shop drawings include material specifications for each component. Ensure shop drawings identify welds by type and size on the detail drawing only, not in table format. **Do not release structures for fabrication until shop drawings have been approved by NCDOT.** Ensure shop drawings contain an itemized bill of materials for all structural components and associated connecting hardware.

Comply with article 1098-1(A) of the *Standard Specifications* for Qualified Products List (QPL) submittals. All shop drawings must include project location description, signal or asset inventory number(s) and project number or work order number.

Summary of information required for metal pole review submittal:

Item	Electronic Submittal	Comments / Special Instructions
Sealed, Approved Signal or ITS Plan/Loading Diagram	1 set	All structure design information needs to reflect the latest approved Signal or ITS plans
Custom Pole Shop Drawings	1 set	Submit drawings on 11" x 17" format media. Show NCDOT signal or asset inventory number(s), Contractor's name and relevant revision number in the title block. All drawings must have a <u>unique drawing number</u> for each project.
Standard Strain Pole Shop Drawings (from the QPL)	1 set	Submit drawings on 11" x 17" format media. Show NCDOT signal inventory number(s), Contractor's name and relevant revision number in the title block. All drawings must have a <u>unique drawing number</u> for each project.
Structure Calculations	1 set	Not required for Standard QPL Poles
Standard Strain Pole Foundation Drawings	1 set	Submit drawings on 11" x 17" format media. Submit a completed Standard Foundation Selection form for each pole using foundation table on Metal Pole Drawing M8.
Custom Foundation Drawings	1 set	Submit drawings on 11" x 17" format media. Show NCDOT signal or asset inventory number(s), Contractor's name and relevant revision number in the title block. All drawings must have a <u>unique drawing number</u> for each project. If QPL Poles are used, include the corresponding QPL pole shop drawings with this submittal.
Foundation Calculations	1 set	Submit copies of LPILE input, output, and pile tip deflection graph per Section titled Drilled Pier Foundations for Metal Poles of this specification for each foundation. Not required for Standard Strain Poles (from the QPL)
Soil Boring Logs and Report	1 set	Report shall include a location plan and a soil classification report including soil capacity, water level, hammer efficiency, soil bearing pressure, soil density, etc. for each pole.

NOTE – All shop drawings and custom foundation design drawings must be sealed by a Professional Engineer licensed in the state of North Carolina. All geotechnical information must be sealed by either a Professional Engineer or Geologist licensed in the state of North Carolina. Include

a title block and revision block on the shop drawings and foundation drawings showing the NCDOT signal or asset inventory number(s).

Shop drawings and foundation drawings may be submitted together or separately for approval. However, shop drawings must be approved before foundations can be reviewed. Foundation designs will be returned without review if the associated shop drawing has not been approved. Boring reports shall include the following: Engineer's summary, boring location maps, soil classification per AASHTO Classification System, hammer efficiency, and Metal Pole Standard Foundation Selection Form. Incomplete submittals will be returned without review. The Reviewer has the right to request additional analysis and copies of the calculations to expedite the approval process.

B. Materials:

Fabricate metal pole from coil or plate steel that meet the requirements of ASTM A 572 Gr 55 or ASTM A 595 Grade A tubes. For structural steel shapes, plates, and bars use, as a minimum, ASTM A572 Gr 50, AASHTO M270 Gr 50, ASTM A709 Gr 50, or an approved equivalent. Provide pole shafts of round or near round (18 sides or more) cross-section, or multi-sided tubular cross-section with no less than six sides, having a uniform linear taper of 0.14 in/ft. Construct shafts from one piece of single-ply plate or coil. For anchor base fabrication, conform to the applicable bolt pattern and orientation as shown on Metal Pole Standard Drawing Sheet M2.

Use the submerged arc process, or other NCDOT previously approved process suitable for shafts, to continuously weld pole shafts along their entire length. Finish the longitudinal seam weld flush with the outside contour of the base metal. Ensure shaft has no circumferential welds except at the lower end joining the shaft to the pole base. Use full penetration groove welds with backing ring for all tube-to-transverse-plate connections in accordance with 1st Edition AASHTO. Provide welding that conforms to Article 1072-18 of the *Standard Specifications*. No field welding on any part of the pole will be permitted unless approved by a qualified Engineer.

After fabrication, hot-dip galvanize steel poles and all assembly components in accordance with section 1076-3 of the *Standard Specifications*. Design structural assemblies with weep holes large enough and properly located to drain molten zinc during the galvanization process. Galvanize hardware in accordance with section 1076-4 of the *Standard Specifications*. Ensure threaded material is brushed and retapped as necessary after galvanizing. Perform repair of damaged galvanizing in accordance with section 1076-7 of the *Standard Specifications*. Ensure all hardware is galvanized steel or stainless steel. The Contractor is responsible for ensuring the Designer/Fabricator specifies connecting hardware and/or materials that prevent a dissimilar metal corrosive reaction.

Ensure each anchor rod is 2-inch minimum diameter and 60-inch length. Provide 10-inch minimum thread projection at the top of the rod, and 8-inch minimum at the bottom of the rod. Use anchor rod assembly and drilled pier foundation materials complying with SP09_R005, hereinafter referred to as *Foundations and Anchor Rod Assemblies for Metal Poles*.

Ensure anchor bolt hole diameters are 1/4-inch larger than the anchor bolt diameters in the base plate.

Provide a circular anchor bolt lock plate securing the anchor bolts at the embedded end with two (2) washers and two (2) nuts. Provide a base plate template matching the bolt circle diameter of the anchor bolt lock plate. Construct plates and templates from 1/4-inch minimum thick steel with a minimum width of 4 inches. Hot-dip galvanizing is not required for both plates.

Provide four (4) heavy hex nuts and four (4) flat washers for each anchor bolt. For nuts, use AASHTO M291 grade 2H, DH, or DH3 or equivalent material. For flat washers, use AASHTO M293 or equivalent material. Ensure anchor bolts have required diameters, lengths, and positions, and will develop strengths comparable to their respective poles.

For each pole, provide a grounding lug with a ½-inch minimum thread diameter, coarse thread stud and nut that will accommodate #4 AWG ground wire. Ensure the lug is electrically bonded to the pole and is conveniently located inside the pole at the hand hole.

Provide a removable pole cap with stainless steel attachment screws for the top of each pole. Ensure cap is cast aluminum conforming to Aluminum Association Alloy 356.0F. Furnish cap attached to the pole with a sturdy stainless-steel chain that is long enough to permit cap to hang clear of the pole-top opening when cap is removed.

Where required by the plans, furnish couplings 42 inches above bottom of the pole base for mounting of pedestrian pushbuttons. Provide mounting points consisting of 1½-inch internally threaded half-couplings complying with the NEC, mounted within the poles. Ensure that couplings are essentially flush with the outside surfaces of the poles and are installed before any required hot-dip galvanizing. Provide a threaded plug in each mounting point. Ensure the surface of the plug is essentially flush with the outer end of the mounting point when installed and has a recessed slot that will accommodate a ½ “drive standard socket wrench.

Metal poles may be erected and fully loaded after concrete has attained a minimum allowable compressive strength of 3,000 psi.

Connect poles to grounding electrodes and bond them to the electrical service grounding electrodes.

When field drilling is necessary for wire or cable entrances into the pole, comply with the following requirements:

- Do not drill holes within 2 inches of any welds.
- Do not drill any holes larger than 3 inches in diameter without checking with the ITS & Signals Structure Engineers.
- Avoid drilling multiple holes along the same cross section of tube shafts.
- Install rubber grommets in all field drilled holes that wire, or cable will directly enter unless holes are drilled for installation of weather heads or couplings.
- Treat the inside of the drilled holes and repair all galvanized surfaces in accordance with Section 1076-7 of the latest edition of the *Standard Specification prior to installing grommets, caps, or plugs*.
- Cap or plug any existing field drilled holes that are no longer used with rubber, aluminum, or stainless-steel hole plugs.

When street lighting is installed on metal signal structures, isolate the conductors feeding the luminaires inside the pole shaft using liquid tight flexible metal conduit (Type LFMC), liquid tight flexible nonmetallic conduit (Type LFNC), high density polyethylene conduit (Type HDPE), or approved equivalent. All conductors supplying power for luminaires must run through an external disconnect prior to entrance into the structure. In accordance with the National Electrical Code (NEC) Article 230.2(E), provide identification of the electrical source provider for the luminaire feeder circuit with contact information on a permanent label located in the pole hand hole near the feeder circuit raceway.

Install a ¼-inch thick plate for a concrete foundation tag to include the following information: concrete grade, depth, diameter, and reinforcement sizes of the installed foundation. Install

galvanized wire mesh to cover gap between the base plate and top of foundation for debris and pest control. Refer to standard drawing M7 for further details.

Immediately notify the Engineer of any structural deficiency that becomes apparent in any assembly, or member of any assembly, because of the design requirements imposed by these specifications, the plans, or the typical drawings.

C. Design:

Unless otherwise specified, design all metal pole support structures using the following 1st Edition AASHTO specifications:

- Use 700-Year MRI and 10-Year MRI wind pressure maps developed from 3-second gust speeds, as provided in Section 3.8.
- Ensure metal pole support structures include natural wind gust loading and truck-induced gust loading for fatigue design, as provided in Sections 11.7.1.2 and 11.7.1.3, respectively. Designs need not consider periodic galloping forces.
- Assume 11.2 mph natural wind gust speed in North Carolina. For natural wind fatigue stress calculations, utilize a drag coefficient (C_d) based on the yearly mean wind velocity of 11.2 mph.
- When selecting Fatigue Importance Factors, utilize Fatigue Importance Category II, as provided for in Table 11.6-1, unless otherwise specified.
- Calculate all forces using applicable equations from Section 5. The Maximum allowable force ratio for all metal pole support designs is 0.9.
- Conform to Sections 10.4.2 and 11.8 for deflection requirements. For CCTV and MVD support structures, ensure maximum deflection at top of pole does not exceed 2.0 percent of pole height.
- Assume the combined minimum weight of a messenger cable bundle (including messenger cable, signal cable and detector lead-in cables) is 1.3 lbs/ft. Assume the combined minimum diameter of the cable bundle is 1.3 inches.

Unless otherwise specified by special loading criteria, the following computed surface area for ice load on signal heads shall be used:

- 3-section, 12-inch, Surface area: 26.0 ft²
- 4-section, 12-inch, Surface area: 32.0 ft²
- 5-section, 12-inch, Surface area: 42.0 ft²

Design a base plate for each pole. The minimum base plate thickness for all poles is determined by the following criteria:

Case 1 Circular or rectangular solid base plate with the upright pole welded to the top surface of base plate with full penetration butt weld, where no stiffeners are provided. A base plate with a small center hole, which is less than 1/3 of the upright diameter, and located concentrically with the upright pole, may be considered as a solid base plate.

The magnitude of bending moment in the base plate, induced by the anchoring force of each anchor bolt is $M = (P \times D_1) / 2$, where

M = bending moment at the critical section of the base plate induced by one (1) anchor bolt

P = anchoring force of each anchor bolt

D_1 = horizontal distance between the anchor bolt center and the outer face of the upright, or the difference between the bolt circle radius and the outside radius of the upright

Locate the critical section at the face of the anchor bolt and perpendicular to the bolt circle radius. The overlapped part of two (2) adjacent critical sections is considered ineffective.

Case 2 Circular or rectangular base plate with the upright pole socketed into and attached to the base plate with two (2) lines of fillet weld, and where no stiffeners are provided, or any base plate with a center hole that is larger in diameter than 1/3 of the upright diameter.

The magnitude of bending moment induced by the anchoring force of each anchor bolt is $M = P \times D_2$,

where P = anchoring force of each anchor bolt

D_2 = horizontal distance between the face of the upright and the face of the anchor bolt nut

Locate the critical section at the face of the anchor bolt top nut and perpendicular to the radius of the bolt circle. The overlapped part of two (2) adjacent critical sections is considered ineffective. If the base plate thickness calculated for Case 2 is less than Case 1, use the thickness calculated for Case 1.

The following additional requirements apply concerning pole base plates.

- Ensure that whichever case governs as defined above, the anchor bolt diameter is set to match the base plate thickness. If the minimum diameter required for the anchor bolt exceeds the thickness required for the base plate, set the base plate thickness equal to the required bolt diameter.
- For all metal poles, use a full penetration groove weld with a backing ring to connect the pole upright component to the base. Refer to Metal Pole Standard Drawing Sheet M3 or M4.

The Professional Engineer is wholly responsible for the design of all poles. Review and acceptance of these designs by the Department does not relieve the said Professional Engineer of his or her responsibility.

D. Mast Arm Poles:

Refer to Metal Pole Standard Drawing Sheets M2 through M5 for fabrication details.

Fabricate metal arm shaft from coil or plate steel that meet the requirements of ASTM A 595 Grade A tubes. Provide arm shafts of round or near round (18 sides or more) cross-section, or multi-sided tubular cross-section with no less than six sides, having a uniform linear taper of 0.14 in/ft. Construct shafts from one piece of single-ply plate or coil, eliminating circumferential weld splices.

Use the submerged arc process, or other NCDOT previously approved process suitable for arm shafts, to continuously weld arm shafts along their entire length. The longitudinal seam weld shall be finished flush to the outside contour of the base metal. Ensure arm shaft has no circumferential welds except at the lower end joining the shaft to the arm flange plate. Use full penetration groove welds with backing ring for all tube-to-transverse-plate connections in accordance with 1st Edition AASHTO. Provide welding that conforms to Article 1072-18 of the *Standard Specifications*, except no field welding on any part of the arm shaft will be permitted unless approved by a qualified Engineer.

After fabrication, hot-dip galvanize steel arm shafts and all assembly components per section 1076 of the *Standard Specifications*. Design arm shafts with weep holes large enough and properly located to drain molten zinc during the galvanization process. Provide hot-dip galvanizing on steel

arm shafts that meets or exceeds ASTM Standard A-123, AASHTO M111, or an approved equivalent. Perform repair of damaged galvanizing that complies with the following *Standard Specifications* article:

Repair of GalvanizingArticle 1076-7

Ensure metal arm shafts permit cables to be installed inside arm shafts. For holes in arm shafts used to accommodate cables, provide full-circumference grommets. Wire access holes for arm flange plates should be deburred, non-grommets, and oversized to fit around 4-inch diameter grommets wire access holes for shaft flange plates.

Provide a minimum of four (4) 1-1/2" diameter high strength bolts for connection between arm plate and pole plate. Increase number of bolts to a minimum of six (6) 1-1/2" diameter high strength bolts when arm lengths are greater than 50'-0" long.

Provide designs with a 6" x 12" hand hole with reinforcing frame for each pole.

Provide a terminal compartment with cover and screws in each pole encompassing the hand hole and containing a 12-terminal barrier type terminal block. Provide two (2) terminal screws with a removable shorting bar between them for each termination. Furnish terminal compartment covers attached to the pole by a sturdy chain or cable approved by the Engineer. Ensure chain or cable is long enough to permit cover to hang clear of the compartment opening when cover is removed and is strong enough to prevent vandalism. Ensure chain or cable will not interfere with service to cables in the pole base.

Have poles permanently stamped above the hand holes with the identification tag details as shown on Metal Pole Standard Drawing Sheets M2 and M4.

Provide a removable end cap with stainless steel attachment screws for the end of each mast arm. Ensure cap is cast aluminum conforming to Aluminum Association Alloy 356.0F. Furnish cap attached to arm with a sturdy chain or cable approved by the Engineer. Ensure chain or cable is long enough to permit cap to hang clear of arm end opening when cap is removed.

Provide pole flange plates and associated gussets and fittings for attachment of required mast arms. As part of each mast arm attachment, provide a cable passage hole in pole to allow passage of cables from pole to arm. Provide a grommets 4-inch diameter cable passage hole on the shaft side of the connection to allow passage of cables from pole to arm.

Furnish all arm plates and necessary attachment hardware, including bolts and brackets.

Provide two (2) extra bolts for each arm.

Provide arms with weatherproof connections for attaching to the pole shaft.

Provide hardware that is galvanized steel, stainless steel, or corrosive-resistant aluminum.

Install metal poles, hardware, and fittings as shown on the manufacturer's installation drawings. Ensure the installed pole, when fully loaded, is within 1 degree 40 minutes (1°40') of vertical. Install poles with the manufacturer's recommended "rake." Where required, use threaded leveling nuts to establish rake.

Install horizontal-type arms with a manufactured rise preventing arm from deflecting below arm attachment height.

Ensure maximum angular rotation of the top of mast arm pole does not exceed 1 degree 40 minutes (1°40'). Ensure allowable mast arm deflection does not exceed that allowed per 1st Edition AASHTO. For all load combination limit states specified under Section 3 of 1st Edition AASHTO, restrict tip of fully loaded arm from going below arm attachment point with the pole.

4.2. DRILLED PIER FOUNDATIONS FOR METAL POLES

Analysis procedures and formulas shall be based on AASHTO 1st Edition, latest ACI-318 code and the *Drilled Shafts: Construction Procedures and Design Methods* FHWA-NHI-10-016 manual. Design methods based on engineering publications or research papers must have prior approval from NCDOT. The Department reserves the right to accept or reject any method used for the analysis.

Ensure deflection at top of foundation does not exceed 1 inch for worst-case (Service Limit State) lateral load.

Use LPILE Plus V6.0 or later for lateral analysis. Submit inputs, results and corresponding graphs with the design calculations.

Calculate skin friction using the α -method for cohesive soils and the β -method for cohesion-less soils (**Broms method will not be accepted**). Detailed descriptions of the “ α ” and “ β ” methods can be found in *FHWA-NHI-10-016*.

Omit first 2.5 feet for cohesive soils when calculating skin friction.

Assume a hammer efficiency of 0.70 unless value is provided.

All CCTV and MVD pole drilled shafts shall be a minimum of 4'-0" diameter. Refer to Standard Drawing Nos. M7 and M8.

Design custom foundations to carry maximum capacity of each metal pole. For standard case strain poles with custom design, use actual shear, axial and moment reactions from the Standard Strain Pole Foundation Selection Table shown on Standard Drawing No. M8.

When poor soil conditions are encountered, which could create an excessively large foundation design, consideration may be given to allow an exemption to the maximum capacity design. The Contractor must gain approval from the Engineer before reducing a foundation's capacity. On projects where poor soil is known to be present, the Contractor should have foundation designs approved before releasing poles for fabrication.

Have the Contractor notify the Engineer if the proposed foundation is to be installed on a slope other than 8H: 1V or flatter.

A. Description:

Furnish and install foundations for NCDOT metal poles with all necessary hardware in accordance with the plans and specifications.

Metal Pole Standards have been developed and implemented by NCDOT for use at signalized intersections in North Carolina. If the plans call for a standard strain pole, then a standard foundation may be selected from the plans. However, the Contractor is not required to use a standard foundation. If the Contractor chooses to design a non-standard site-specific foundation for a standard strain pole or if the plans call for a non-standard site-specific pole, design the foundation to conform to the applicable provisions in the NCDOT Metal Pole Standard Drawings and Section B4 (Non-Standard Foundation Design) below. If non-standard site-specific foundations are designed for standard QPL approved strain poles, the foundation designer must use the design moment specified by load case on Metal Pole Standard Drawing Sheet M8. Failure to conform to this requirement will be grounds for rejection of the design.

If the Contractor chooses to design a non-standard foundation for a standard strain pole and the soil test results indicate a standard foundation is feasible for the site, the Contractor will be paid the cost of the standard foundation. Any additional cost associated with a non-standard site-specific foundation including additional materials, labor and equipment will be considered incidental to the

cost of the standard foundation. All costs for the non-standard foundation design will be considered incidental to the cost of the standard foundation.

B. Soil Test and Foundation Determination:

1. General:

Drilled piers are reinforced concrete sections, cast-in-place against in situ, undisturbed material. Drilled piers are of straight shaft type and vertical.

2. Soil Test:

Perform a soil test at each proposed metal pole location. Complete all required fill placement and excavation at each pole location to finished grade before drilling each boring. Soil tests performed that are not in compliance with this requirement may be rejected and will not be paid. Drill one boring to a depth of 26 feet within a 25-foot radius of each proposed foundation.

Perform standard penetration tests (SPT) in accordance with ASTM D 1586 at depths of 1, 2.5, 5, 7.5, 10, 15, 20 and 26 feet. Discontinue the boring if one of the following occurs:

- A total of 100 blows have been applied in any two consecutive 6-inch intervals.
- A total of 50 blows have been applied with < 3-inch penetration.

Describe each pole location along the project corridor in a manner that is easily discernible to both the Contractor's Designer and NCDOT Reviewers. If the pole is at an intersection, label the boring the "Intersection of (*Route or SR #*), (*Street Name*) and (*Route or SR #*), (*Street Name*), _____ County, Signal or Asset Inventory No. _____". Label borings with "B- *N, S, E, W, NE, NW, SE or SW*" corresponding to the quadrant location within the intersection.

If the pole location is located between intersections, provide a coordinate location and offset, or milepost number and offset. Pole numbers should be made available to the Drill Contractor. Include pole numbers in the boring label if they are available. If they are not available, ensure the boring labels can be cross-referenced to corresponding pole numbers. For each boring, submit a legible (hand-written or typed) boring log signed and sealed by a licensed Geologist or Professional Engineer registered in North Carolina. Include on each boring the SPT blow counts and N-values at each depth, depth of the boring, hammer efficiency, depth of water table and a general description of the soil types encountered using the AASHTO Classification System.

Borings that cannot be easily correlated to their specific pole location will be returned to the Contractor for clarification; or if approved by the Engineer, the foundation may be designed using the worst-case soil condition obtained as part of this project.

3. Standard Foundation Determination:

Use the following method for determining the Design N-value:

$$N_{AVG} = \frac{N_{@1'} + N_{@2.5'} + \dots + N_{@Deepest\ Boring\ Depth}}{Total\ Number\ of\ N\ values}$$

$$Y = (N_{@1'})^2 + (N_{@2.5'})^2 + \dots + (N_{@Deepest\ Boring\ Depth})^2$$

$$Z = N_{@1'} + N_{@2.5'} + \dots + N_{@Deepest\ Boring\ Depth}$$

$$N_{STD\ DEV} = \sqrt{\left(\frac{(Total\ Number\ of\ N\ values \times Y) - Z^2}{(Total\ Number\ of\ N\ values) \times (Total\ Number\ of\ N\ values - 1)} \right)}$$

Design N-value equals lesser of the following two conditions:

$$N_{AVG} - (N_{STD DEV} \times 0.45)$$

OR

$$\text{Average of First Four (4)N values} = \frac{N_{@1'} + N_{@2.5'} + N_{@5'} + N_{@7.5'}}{4}$$

Note: If less than four (4) N-values are obtained because of criteria listed in Section 2 above, use average of N-values collected for second condition. Do not include the N-value at the deepest boring depth for above calculations if the boring is discontinued at or before the required boring depth because of criteria listed in Section 2 above. Use N-value of zero (0) for weight of hammer or weight of rod. If N-value is greater than fifty (50), reduce N-value to fifty (50) for calculations.

If standard NCDOT strain poles are shown on the plans and the Contractor chooses to use standard foundations, determine a drilled pier length, “L,” for each signal pole from the Standard Strain Pole Foundations Chart (sheet M8) based on the Design N-value and the predominant soil type. For each standard pole location, submit a completed “Metal Pole Standard Foundation Selection Form” signed by the Contractor’s representative. Signature on form is for verification purposes only. Include the Design N-value calculation and resulting drilled pier length, “L,” on each form.

If non-standard site-specific poles are shown on the plans, submit completed boring logs collected in accordance with Section 2 (Soil Test) along with pole loading diagrams from the plans to the Contractor-selected pole Fabricator to assist in the pole and foundation design.

If one of the following occurs, the Standard Foundations Chart shown on the plans may not be used and a non-standard foundation may be required. In such case, contact the Engineer.

- The Design N-value is less than four (4).
- The drilled pier length, “L”, determined from the Standard Foundations Chart, is greater than the depth of the corresponding boring.

In the case where a standard foundation cannot be used, the Department will be responsible for the additional cost of the non-standard foundation.

Foundation designs are based on level ground around the traffic signal pole. If the slope around the edge of the drilled pier is steeper than 8:1 (H:V) or the proposed foundation will be less than 10 feet from the top of an embankment slope, the Contractor is responsible for providing slope information to the foundation Designer and to the Engineer so it can be considered in the design.

The “Metal Pole Standard Foundation Selection Form” may be found at:

<https://connect.ncdot.gov/resources/safety/Pages/ITS-Design-Resources.aspx>

If assistance is needed, contact the Engineer.

4. Non-Standard Foundation Design:

Design non-standard foundations based upon site-specific soil test information collected in accordance with Section 2 (Soil Test). Design drilled piers for side resistance in accordance with

Section 10.8 of the 2014 AASHTO LRFD Bridge Design Specifications, 7th Edition. Use computer software LPILE version-6.0 or later manufactured by Ensoft, Inc. to analyze drilled piers. Use computer software gINT V8i or later manufactured by Bentley Systems, Inc. with the current NCDOT gINT library and data template to produce SPT boring logs. Provide a drilled pier foundation for each pole with a length and diameter resulting in horizontal lateral movement less than 1 inch at top of the pier, and horizontal rotational movement less than 1 inch at the edge of pier. Contact the Engineer for pole loading diagrams of standard poles used for non-standard foundation designs. Submit non-standard foundation designs including drawings, calculations, and soil boring logs to the Engineer for review and approval before construction.

C. Drilled Pier Construction:

Construct drilled pier foundation and Install anchor rod assemblies in accordance with the Foundations and Anchor Rod Assemblies for Metal Poles Standard Special Provision SP09-R005 located at:

<https://connect.ncdot.gov/resources/Specifications/Pages/2024-Specifications-and-Special-Provisions.aspx>

4.3. POLE NUMBERING SYSTEM

Attach an identification tag to each pole shaft section as shown on Metal Pole Standard Sheet M2 “Typical Fabrication Details for All Metal Poles.”

4.4. MEASUREMENT AND PAYMENT

Actual number of metal poles with single mast arms furnished, installed, and accepted.

Actual number of designs for mast arms with metal poles furnished and accepted.

Actual number of soil tests with SPT borings drilled furnished and accepted.

Actual volume of concrete poured in cubic yards of drilled pier foundation furnished, installed and accepted.

No measurement will be made for foundation designs prepared with metal pole designs, as these will be considered incidental to designing Traffic Signal , CCTV or MVD support structures.

Payment will be made under:

Metal Pole with Single Mast Arm	Each
Mast Arm with Metal Pole Design	Each
Soil Test	Each
Drilled Pier Foundation.....	Cubic Yard

5. ETHERNET EDGE SWITCH

Furnish and install a managed Ethernet edge switch as specified below that is fully compatible, interoperable, and completely interchangeable and functional within the existing City, Division, or Statewide traffic signal system communications network.

5.1. DESCRIPTION

A. Ethernet Edge Switch:

Furnish and install a hardened, field Ethernet edge switch (hereafter “edge switch”) for the traffic signal controller or ITS device as specified below. Ensure that the edge switch provides wire-speed,

fast Ethernet connectivity at transmission rates of 1000 megabits per second from each remote traffic signal controller or ITS device location to the routing switches.

Contact the City or NCDIT to arrange for the programming of the new Field Ethernet Switches with the necessary network configuration data, including but not limited to, the IP Address, Default Gateway, Subnet Mask and VLAN ID information. Provide a minimum ten (10) working days notice to allow the City or NCDIT to program the new devices.

B. Network Management:

Ensure that the edge switch is fully compatible with the existing City, Division, or Statewide Network Management Software.

5.2. MATERIALS

A. General:

Ensure that the edge switch is fully compatible and interoperable with the trunk Ethernet network interface and that the edge switch supports half and full duplex Ethernet communications.

Furnish an edge switch that provide 99.999% error-free operation, and that complies with the Electronic Industries Alliance (EIA) Ethernet data communication requirements using single-mode fiber-optic transmission medium and copper transmission medium. Ensure that the edge switch has a minimum mean time between failures (MTBF) of 10 years, or 87,600 hours, as calculated using the Bellcore/Telcordia SR-332 standard for reliability prediction.

B. Compatibility Acceptance

The Engineer has the authority to require the Contractor to submit a sample Field Ethernet Switch and SFP along with all supporting documentation, software and testing procedures to allow a compatibility acceptance test be performed prior to approving the proposed Field Ethernet Switch and Field Ethernet Transceiver for deployment. **The Compatibility Acceptance testing will ensure that the proposed device is 100% compatible and interoperable with the existing City, Division, or Statewide Signal System network, monitoring software and Traffic Operations Center network hardware.** Allow fifteen (15) working days for the Compatibility Acceptance Testing to be performed

C. Standards:

Ensure that the edge switch complies with all applicable IEEE networking standards for Ethernet communications, including but not limited to:

- IEEE 802.1D standard for media access control (MAC) bridges used with the Spanning Tree Protocol (STP);
- IEEE 802.1Q standard for port-based virtual local area networks (VLANs);
- IEEE 802.1P standard for Quality of Service (QoS);
- IEEE 802.1w standard for MAC bridges used with the Rapid Spanning Tree Protocol (RSTP);
- IEEE 802.1s standard for MAC bridges used with the Multiple Spanning Tree Protocol;
- IEEE 802.1x standard for port based network access control, including RADIUS;
- IEEE 802.3 standard for local area network (LAN) and metropolitan area network (MAN) access and physical layer specifications;
- IEEE 802.3u supplement standard regarding 100 Base TX/100 Base FX;
- IEEE 802.3x standard regarding flow control with full duplex operation; and
- IFC 2236 regarding IGMP v2 compliance.

- IEEE 802.1AB Link Layer Discovery Protocol (LLDP)
- IEEE 802.3ad Ethernet Link Aggregation
- IEEE 802.3i for 10BASE-T (10 Mbit/s over Fiber-Optic)
- IEEE 802.3ab for 1000BASE-T (1Gbit/s over Ethernet)
- IEEE 802.3z for 1000BASE-X (1 Gbit/s Ethernet over Fiber-Optic)

D. Functional:

Ensure that the edge switch supports all Layer 2 management features and certain Layer 3 features related to multicast data transmission and routing. These features shall include, but not be limited to:

- An STP healing/convergence rate that meets or exceeds specifications published in the IEEE 802.1D standard.
- An RSTP healing/convergence rate that meets or exceeds specifications published in the IEEE 802.1w standard.
- An Ethernet edge switch that is a port-based VLAN and supports VLAN tagging that meets or exceeds specifications as published in the IEEE 802.1Q standard, and has a minimum 4-kilobit VLAN address table (254 simultaneous).
- A forwarding/filtering rate that is a minimum of 14,880 packets per second for 10 megabits per second and 148,800 packets per second for 100 megabits per second.
- A minimum 4-kilobit MAC address table.
- Support of Traffic Class Expediting and Dynamic Multicast Filtering.
- Support of, at a minimum, snooping of Version 2 & 3 of the Internet Group Management Protocol (IGMP).
- Support of remote and local setup and management via telnet or secure Web-based GUI and command line interfaces.
- Support of the Simple Network Management Protocol version 3 (SNMPv3). Verify that the Ethernet edge switch can be accessed using the resident EIA-232 management port, a telecommunication network, or the Trivial File Transfer Protocol (TFTP).
- Port security through controlling access by the users. Ensure that the Ethernet edge switch has the capability to generate an alarm and shut down ports when an unauthorized user accesses the network.
- Support of remote monitoring (RMON-1 & RMON-2) of the Ethernet agent.
- Support of the TFTP and SNTP. Ensure that the Ethernet edge switch supports port mirroring for troubleshooting purposes when combined with a network analyzer.

E. Physical Features:

Ports: Provide 10/100/1000 Mbps auto-negotiating ports (RJ-45) copper Fast Ethernet ports for all edge switches. Provide auto-negotiation circuitry that will automatically negotiate the highest possible data rate and duplex operation possible with attached devices supporting the IEEE 802.3 Clause 28 auto-negotiation standard.

Optical Ports: Ensure that all fiber-optic link ports operate at 1310 or 1550 nanometers in single mode. Provide Type LC connectors for the optical ports, as specified in the Plans or by the Engineer. Do not use mechanical transfer registered jack (MTRJ) type connectors.

Provide an edge switch having a minimum of two optical 100/1000 Base X ports capable of transmitting data at 100/1000 megabits per second. Ensure that each optical port consists of a pair of

fibers; one fiber will transmit (TX) data and one fiber will receive (RX) data. Ensure that the optical ports have an optical power budget of at least 15 dB. Provide small form-factor pluggable modules (SFPs) with a maximum range that meets or exceeds the distance requirement as indicated on the Plans.

Copper Ports: Provide an edge switch that includes a minimum of four copper ports. Provide Type RJ-45 copper ports and that auto-negotiate speed (i.e., 10/100/1000 Base) and duplex (i.e., full or half). Ensure that all 10/100/1000 Base TX ports meet the specifications detailed in this section and are compliant with the IEEE 802.3 standard pinouts. Ensure that all Category 6 unshielded twisted pair/shielded twisted pair network cables are compliant with the EIA/TIA-568-B standard.

Port Security: Ensure that the edge switch supports/complies with the following (remotely) minimum requirements:

- Ability to configure static MAC addresses access;
- Ability to disable automatic address learning per ports; know hereafter as Secure Port. Secure Ports only forward; and
- Trap and alarm upon any unauthorized MAC address and shutdown for programmable duration. Port shutdown requires administrator to manually reset the port before communications are allowed.

F. Management Capabilities:

Ensure that the edge switch supports all Layer 2 management features and certain Layer 3 features related to multicast data transmission and routing. These features shall include, but not be limited to:

- An STP healing/convergence rate that meets or exceeds specifications published in the IEEE 802.1 D standards;
- An RSTP healing/convergence rate that meets or exceeds specifications published in the IEEE 802.1w standard;
- An Ethernet edge switch that is a port-based VLAN and supports VLAN tagging that meets or exceeds specifications as published in the IEEE 802.1Q standard, and has a minimum 4-kilobit VLAN address table (254 simultaneous);
- A forwarding/filtering rate that is a minimum of 14,880 packets per second for 10 megabits per second, 148,800 packets per second for 100 megabits per second and 1,488,000 packets per second for 1000 megabits per second;
- A minimum 4-kilobit MAC address table;
- Support of Traffic Class Expediting and Dynamic Multicast Filtering.
- Support of, at a minimum, snooping of Version 2 & 3 of the Internet Group Management Protocol (IGMP);
- Support of remote and local setup and management via telnet or secure Web-based GUI and command line interfaces; and
- Support of the Simple Network Management Protocol (SNMP). Verify that the Ethernet edge switch can be accessed using the resident EIA-232 management port, a telecommunication network, or the Trivial File Transfer Protocol (TFTP).

Network Capabilities: Provide an edge switch that supports/complies with the following minimum requirements:

- Provide full implementation of IGMPv2 snooping (RFC 2236);

- Provide full implementation of SNMPv1, SNMPv2c, and/or SNMPv3;
- Provide support for the following RMON–I groups, at a minimum:
 - Part 1: Statistics
 - Part 2: History
 - Part 3: Alarm
 - Part 9: Event
- Provide support for the following RMON–2 groups, at a minimum:
 - Part 13: Address Map
 - Part 16: Layer Host
 - Part 17: Layer Matrix
 - Part 18: User History
- Capable of mirroring any port to any other port within the switch;
- Meet the IEEE 802.1Q (VLAN) standard per port for up to four VLANs;
- Meet the IEEE 802.3ad (Port Trunking) standard for a minimum of two groups of four ports;
- Password manageable;
- Telnet/CLI;
- HTTP (Embedded Web Server) with Secure Sockets Layer (SSL); and
- Full implementation of RFC 783 (TFTP) to allow remote firmware upgrades.

Network Security: Provide an edge switch that supports/complies with the following (remotely) minimum network security requirements:

- Multi-level user passwords;
- RADIUS centralized password management (IEEE 802.1X);
- SNMPv3 encrypted authentication and access security;
- Port security through controlling access by the users: ensure that the Ethernet edge switch has the capability to generate an alarm and shut down ports when an unauthorized user accesses the network;
- Support of remote monitoring (RMON-1&2) of the Ethernet agent; and
- Support of the TFTP and SNTP. Ensure that the Ethernet edge switch supports port mirroring for troubleshooting purposes when combined with a network analyzer.

G. Electrical Specifications:

Ensure that the edge switch operates and power is supplied with 115 volts of alternating current (VAC). Ensure that the edge switch has a minimum operating input of 110 VAC and a maximum operating input of 130 VAC. Ensure that if the device requires operating voltages other than 120 VAC, supply the required voltage converter. Ensure that the maximum power consumption does not exceed 50 watts. Ensure that the edge switch has diagnostic light emitting diodes (LEDs), including link, TX, RX, speed (for Category 6 ports only), and power LEDs.

H. Environmental Specifications:

Ensure that the edge switch performs all of the required functions during and after being subjected to an ambient operating temperature range of -30 degrees to 165 degrees Fahrenheit as defined in the environmental requirements section of the NEMA TS 2 standard, with a noncondensing humidity of 0 to 95%.

Provide certification that the device has successfully completed environmental testing as defined in the environmental requirements section of the NEMA TS 2 standard. Provide certification that the device meets the vibration and shock resistance requirements of Sections 2.1.9 and 2.1.10,

respectively, of the NEMA TS 2 standard. Ensure that the edge switch is protected from rain, dust, corrosive elements, and typical conditions found in a roadside environment.

The edge switch shall meet or exceed the following environmental standards:

- IEEE 1613 (electric utility substations)
- IEC 61850-3 (electric utility substations)
- IEEE 61800-3 (variable speed drive systems)
- IEC 61000-6-2 (generic industrial)
- EMF – FCC Part 15 CISPR (EN5502) Class A

I. Ethernet Patch Cable:

Furnish a factory pre-terminated/pre-connectorized Ethernet patch cable with each edge switch. Furnish Ethernet patch cables meeting the following physical requirements:

- Five (5)-foot length
- Category 6 or better
- Factory-installed RJ-45 connectors on both ends
- Molded anti-snag hoods over connectors
- Gold plated connectors
- Copper-clad aluminum is **NOT** allowed.

Furnish Fast Ethernet patch cords meeting the following minimum performance requirements:

- TIA/EIA-568-B-5, Additional Transmission Performance Specifications for 4-pair 100 Ω Enhanced Category 6 Cabling
- Frequency Range: 1-100 MHz
- Near-End Crosstalk (NEXT): 30.1 dB
- Power-sum NEXT: 27.1 dB
- Attenuation to Crosstalk Ratio (ACR): 6.1 dB
- Power-sum ACR: 3.1 dB
- Return Loss: 10dB
- Propagation Delay: 548 nsec

5.3. CONSTRUCTION METHODS

A. General:

Ensure that the edge switch is UL listed.

Verify that network/field/data patch cords meet all ANSI/EIA/TIA requirements for Category 6 four-pair unshielded twisted pair cabling with stranded conductors and RJ45 connectors.

Contact the City, Division, or NCDIT a minimum of 10 working days prior to installation to allow for the programming of the edge switch.

B. Edge Switch:

Mount the edge switch inside each field cabinet by securely fastening the edge switch to the upper end of the right rear vertical rail of the equipment rack using manufacturer-recommended or Engineer-approved attachment methods, attachment hardware and fasteners.

Ensure that the edge switch is mounted securely in the cabinet and is fully accessible by field technicians without blocking access to other equipment. Verify that fiber-optic jumpers consist of a length of cable that has connectors on both ends, primarily used for interconnecting termination or patching facilities and/or equipment.

5.4. MEASUREMENT AND PAYMENT

Ethernet edge switch will be measured and paid as the actual number of Ethernet edge switches furnished, installed, and accepted.

No separate measurement will be made for Ethernet patch cable, small form factor pluggable modules (SFPs), power cord, mounting hardware, nuts, bolts, brackets, or edge switch programming as these will be considered incidental to furnishing and installing the edge switch.

Payment will be made under:

Ethernet Edge Switch.....Each

Project Special Provisions
Structure

Table of Contents

<u>Title</u>	<u>Page</u>
MAINTENANCE AND PROTECTION OF TRAFFIC BENEATH PROPOSED STRUCTURE AT STA. 22+71.80 -L- (08-13-04)	ST-2
THERMAL SPRAYED COATINGS (METALLIZATION) (12-01-17)	ST-3
STRIP SEAL EXPANSION JOINTS (06-25-20)	ST-5
FALSEWORK AND FORMWORK (2-14-22)	ST-10
SUBMITTAL OF WORKING DRAWINGS (11-30-23)	ST-16
CRANE SAFETY (6-20-19)	ST-22
GROUT FOR STRUCTURES (12-1-17)	ST-23
ASBESTOS ASSESSMENT FOR BRIDGE DEMOLITION AND RENOVATION ACTIVITIES (11-30-23)	ST-24
CLASSIC CONCRETE BRIDGE RAIL (SPECIAL)	ST-27

DocuSigned by:
John C. Morrison
9F23075CFC91480...
1/11/2024

Project B-4654**ST-2****Wake County****MAINTENANCE AND PROTECTION OF TRAFFIC
BENEATH PROPOSED STRUCTURE AT STATION 22+71.80 -L-****(8-13-04)****GENERAL**

Maintain traffic on US 70 as shown in Traffic Control Plans and as directed by the Engineer.

Provide a minimum temporary vertical clearance of 15'-6" at all times during construction.

Submit plans and calculations for review and approval for protecting traffic and bracing girders, as described herein, at the above station before beginning work at this location. Have the drawings and design calculations prepared, signed, and sealed by a North Carolina Registered Professional Engineer. The approval of the Engineer will not relieve the Contractor of the responsibility for the safety of the method or equipment.

PROTECTION OF TRAFFIC

Protect traffic from any operation that affords the opportunity for construction materials, equipment, tools, etc. to be dropped into the path of traffic beneath the structure. Based on Contractor means and methods determine and clearly define all dead and live loads for this system, which, at a minimum, shall be installed between beams or girders over any travelway or shoulder area where traffic is maintained. Install the protective system before beginning any construction operations over traffic. In addition, for these same areas, keep the overhang falsework in place until after the rails have been poured.

BRACING GIRDERS

Brace girders to resist wind forces, weight of forms and other temporary loads, especially those eccentric to the vertical axis of the member during all stages of erection and construction. Before casting of intermediate diaphragms, decks, or connecting steel diaphragms do not allow the horizontal movement of girders to exceed 1/2 inch.

BASIS OF PAYMENT

Payment at the contract unit prices for the various pay items will be full compensation for the above work.

Project B-4654**ST-3****Wake County****THERMAL SPRAYED COATINGS (METALLIZATION)****(12-1-2017)****DESCRIPTION**

Apply a thermal sprayed coating (TSC) and sealer to metal surfaces in accordance with the *Thermal Sprayed Coatings (Metallization) Program* and as specified herein when called for on the plans or by other Special Provisions. Use only Arc Sprayed application methods to apply TSC. The Engineer must approve other methods of application.

The *Thermal Sprayed Coatings (Metallization) Program* is available on the Materials and Tests Unit website.

QUALIFICATIONS

Only use NCDOT approved TSC Contractors meeting the requirements outlined in the *Thermal Sprayed Coatings (Metallization) Program*.

MATERIALS

Use only materials meeting the requirements of Section 7 of the *Thermal Sprayed Coatings (Metallization) Program*.

SURFACE PREPARATION AND TSC APPLICATION

Surface preparation of TSC surfaces shall meet the requirements of Section 8 of the *Thermal Sprayed Coatings (Metallization) Program*. Apply TSC with the alloy to the thickness specified on the plans or as required by *Thermal Sprayed Coatings (Metallization) Program*.

INSPECTION AND TESTING

The TSC Contractor must conduct inspections and tests listed in the *Thermal Sprayed Coatings (Metallization) Program*.

REPAIRS

Perform all shop repairs in accordance with the procedures outlined in the *Thermal Sprayed Coatings (Metallization) Program*.

Repairs associated with field welding shall be made by removing the existing metallizing by blast or power tool cleaning. Affected areas shall be addressed as follows:

(A) For Marine Environments, incorporate a minimum surface preparation in accordance with SSPC SP-11 (Power Tool Cleaning to Bare Metal) and require an approved epoxy mastic coating applied in accordance with the manufacturer's recommendation. Apply a minimum of two (2) coats at a rate of 5-7 (WFT) per coat to the affected area.

(B) For Non-Marine Environments, incorporate a minimum surface preparation in accordance with SSPC SP-11 (Power Tool Cleaning to Bare Metal) and require an approved organic

Project B-4654

ST-4

Wake County

zinc-rich coating applied in accordance with the manufacturer's recommendation. Apply a minimum of two (2) coats at a rate of 5-7 (WFT) per coat to the affected area.

- (1) Minor localized areas less than or equal to 0.1 ft² with exposed substrate shall be repaired as outlined above for marine and non-marine environments.
- (2) Large localized areas greater than 0.1 ft² with exposed substrate shall require the Contractor to submit a detailed repair procedure to the Engineer for review and approval.
- (3) Repair methods for areas where the substrate has not been exposed shall be mutually agreed upon between the Contractor and TSC Contractor as approved by the Engineer.

TWELVE MONTH OBSERVATION PERIOD

All TSC materials applied under the *Thermal Sprayed Coatings (Metallization) Program* shall be evaluated twelve (12) months after project acceptance for defective materials and workmanship.

MEASUREMENT AND PAYMENT

The contract price bid for the metal component to which the TSC is applied will be full compensation for the thermal sprayed coating.

Project B-4654**ST-5****Wake County****STRIP SEAL EXPANSION JOINTS****(06-25-20)****GENERAL**

This Special Provision covers furnishing and installing strip seal expansion joints as shown on the contract drawings and in accordance with this Special Provision, the *Standard Specifications* and the manufacturer's recommendation. All materials, labor, equipment, and incidentals necessary for proper installation of the strip seal expansion joints are included.

MATERIALS

Provide strip seal expansion joints capable of accommodating a total movement measured parallel to the centerline of the roadway as shown on plans. The components of the expansion joint include steel retainer rails and a neoprene seal gland.

The steel retainer rails shall consist of a "P" shape profile configuration with anchor studs welded to the concrete face. The rails shall have a minimum height of 8 inches, a minimum thickness of ½ inch and a maximum top surface (at the riding surface) width of 2 inches. Use AASHTO M270 Grade 36 or Grade 50 steel for the steel retainer rails.

The neoprene gland shall be extruded synthetic rubber with virgin polychloroprene as the only polymer. The gland manufacturer shall provide a Type 4 certification, in accordance with the *Standard Specifications*, attesting the gland has been tested and meets the following minimum properties:

PHYSICAL PROPERTY	TEST METHOD	REQUIREMENTS
Tensile Strength, psi (min.)	ASTM D412	2,000
Elongation at break, % (min.)	ASTM D412	250
Hardness, Type A durometer, points	ASTM D2240 Modified	60 ± 10
Oven aging, 70h @ 212°F Tensile strength, % change (max.) Elongation, % change (max.) Hardness, points change (max.)	ASTM D573	-20 -20 0 to +10
Oil Swell, ASTM Oil No. 3, 70h @ 212°F Weight change, % (max.)	ASTM D471	45
Ozone resistance 20% strain, 300 pphm in air 70h @ 104°F	ASTM D1149 Modified	No cracks
Low temperature stiffening, 7 days @ 14°F Hardness, Type A durometer, points change	ASTM D2240	0 to +15
Compression Set, 70h @ 212°F (max.)	ASTM D395 Method B (modified)	40%

SHOP DRAWINGS

Submit a set of complete shop drawings to the Engineer via email for review, comments and acceptance and carbon copy (cc) the Structures Management Unit Working Drawing Review Group (SMU-wdr@ncdot.gov). Send the drawings well in advance of the scheduled installation time for the strip seal expansion joint rail. Prior to submitting the shop drawings, have someone, other than the draftsman who prepares the drawings, check all detailed drawings and include the signatures of both the draftsman and checker on each sheet of the drawings. The Engineer returns unchecked drawings to the Contractor.

Steel retainer rails shall consist of one-piece construction including upturns. Welding two (2) or more components to obtain the required cross-sectional shape is not permitted. Show all dimensions, anchor stud locations, welded splice details, splice locations and any other details or data necessary to fabricate the joint on the shop drawings. Include the joint model number and joint movement range. Draw all details to scale. Identify, in detail, welding procedures to be performed in fabricating the joint. As a minimum, also show the following on the drawings:

- (A) All field splice locations. Steel retainer rail field splices are only permitted at crown points, locations with abrupt changes in the deck slab cross slope, and at travel lane lines. Splices within travel lanes are not permitted and splicing on edge lines is not required. For the location of travel lane markings at the strip seal expansion joint, see the structure plans. At the field splice locations, locate the horizontal stud anchors 3 inches from the centerline of the splice.
- (B) Details of the shipping device for the steel retainer rail assemblies. Ensure the device is capable of resisting shipping and handling forces without causing damage to the steel retainer rail assemblies or metallized coating.
- (C) The method of supporting steel retainer rails horizontally and vertically during joint installation and placement of concrete to ensure stability and proper alignment. Ensure the method is capable of resisting construction forces without causing damage to the steel retainer rail assemblies or metallized coating and are adjustable to account for variable temperature settings. Place supports near field splices of steel retainer rails to ensure that splices are straight and even.
- (D) The proposed procedure to correct for the effects of beam movement and rotation when setting width of joint opening.
- (E) The proposed installation procedure including the sequence and suggested direction of the concrete pour(s).
- (F) The proposed mechanism to allow joint translation after the deck pour.
- (G) A section through the joint detail showing horizontal offset dimensions of the steel retainer rails from the centerline of the joint. This detail is required when the vertical face of the joint opening is not perpendicular to the roadway surface (e.g. when the roadway grade is significant).

Project B-4654**ST-7****Wake County****FABRICATION**

Fabricate the strip seal joint components in accordance with the approved shop drawings and the plans.

Splice sections of steel retainer rail in the shop to obtain required lengths. Do not use short pieces of steel retainer rail less than 6 feet long unless required at curbs, sidewalks or staged construction locations. Splices in an individual steel retainer rail are only permitted where a construction joint is specifically required by the plans, joint segment length exceeds 50 feet, or approved by the Engineer in writing.

At splice locations where changes in deck slab cross slope occur, cut the ends of steel retainer rails parallel to the bridge centerline for skews less than 80° and greater than 100°.

Provide a neoprene gland that is compatible with the steel retainer rail. Produce a single continuous neoprene gland for the entire length of the joint. When necessary, only vulcanized splicing of the gland in the shop is permitted. Ensure the convolution(s) of the gland does not project above the top of the steel retainer rails when the ambient temperature results in the minimum joint opening.

SHIPMENT

Bolt the steel retainer rails together in the shop to form matching pairs. Clearly mark each pair to identify where they are to be placed. Ship the neoprene gland(s) together with the steel retainer rail(s) and clearly mark them to identify where they are to be placed.

INSTALLATION

Install the strip seal expansion joint in accordance with the plan details, this Special Provision, the *Standard Specifications*, and the manufacturer's recommended installation procedures. Have a manufacturer's representative present during installation of the joint.

Install the steel retainer rail assemblies at proper grade and alignment. See contract drawings for width of joint opening.

Bolt, weld or clamp steel retainer rail assemblies in position using temporary or sacrificial brackets as required. Do not use temporary or sacrificial support brackets, bolts, clamps, etc. between the faces of the steel retainer rails. Do not weld within two (2) inches of steel retainer rail surfaces exposed in the completed structure. Do not weld strip seal expansion joint components to reinforcing steel or structural steel.

For staged construction, install steel retainer rail assemblies in a given subsequent stage to align with those installed in an adjacent prior stage after deflection and rotation due to deck casting of adjoining spans has occurred.

Protect metalized steel retainer rail assemblies during screeding operations per the manufacturer's recommendations. Provide temporary blocking material in the steel retainer rail seal cavities to prevent concrete intrusion during deck pour and finishing.

Loosen any temporary or sacrificial support brackets, bolts, clamps, etc. that span across the joint after initial set of concrete, but not more than two hours after conclusion of concrete placement.

Install the neoprene gland after completion of deck casting. Use a single continuous neoprene gland for the entire length of the joint. Field splicing of the neoprene gland is not permitted. Remove all joint form material and blocking material prior to installing the gland. Field install the gland in accordance with manufacturer's recommendations. Thoroughly coat all contact surfaces between the gland and the steel retainer rail seal cavities with an adhesive lubricant before setting the gland in place. Use lubricant adhesive that conforms to ASTM D4070 and is compatible with manufacture's strip seal expansion joint to attach neoprene gland to the steel retainer rails.

INSPECTION

The Engineer inspects the joint system for proper alignment and proper stud placement and attachment. If any aspect of the strip seal expansion joint is deemed unacceptable, make the necessary corrections.

When concrete is cast, use a non-aluminum, 10 foot, true-to-line straight-edge to check and grade the top of the slab on each side of the joint to ensure smooth transition between spans.

(A) Watertight Integrity Test

- (1) Upon completion of each strip seal expansion joint, perform a watertight integrity test on the top surface to detect any leakage. Cover the roadway section of the joint from curb to curb, or barrier rail to barrier rail, with water, either ponded or flowing, not less than 1 inch above the roadway surface at all points. Block sidewalk sections and secure an unnozzled water hose delivering approximately 1 gallon of water per minute to the inside face of the bridge railing, trained in a downward position about 6 inches above the sidewalk, such that there is continuous flow of water across the sidewalk and down the curb face of the joint.
- (2) Maintain the ponding or flowing of water on the roadway and continuous flow across sidewalks and curbs for a period of 5 hours. At the conclusion of the test, the underside of the joint is closely examined for leakage. The strip seal expansion joint is considered watertight if no obvious wetness is visible on the Engineer's finger after touching a number of underdeck areas. Damp concrete that does not impart wetness to the finger is not considered a sign of leakage.
- (3) If the joint system leaks, locate the place(s) of leakage and take any repair measures necessary to stop the leakage at no additional cost to the Department. Use repair measures recommended by the manufacturer and approved by the Engineer prior to beginning corrective work.
- (4) If measures to eliminate leakage are taken, perform a subsequent watertight integrity test subject to the same conditions as the original test. Subsequent tests carry the same responsibility as the original test and are performed at no additional cost to the Department.

Project B-4654

ST-9

Wake County

MEASUREMENT AND PAYMENT

Strip Seal Expansion Joints will be paid for at the lump sum contract price. Payment will be full compensation for furnishing all material, including any steel accessory plates for sidewalks, medians and rails, labor, tools, and incidentals necessary for installing the strip seal expansion joint in place and including all materials, labor, tools and incidentals for performing the original watertight integrity test.

Payment will be made under:

Pay Item

Pay Unit

Strip Seal Expansion Joints

Lump Sum

Project B-4654**ST-10****Wake County****FALSEWORK AND FORMWORK****(11-30-23)****GENERAL**

Use this Special Provision as a guide to develop temporary works submittals required by the *Standard Specifications* or other provisions; no additional submittals are required herein. Such temporary works include, but are not limited to, falsework and formwork.

Falsework is any temporary construction used to support the permanent structure until it becomes self-supporting. Formwork is the temporary structure or mold used to retain plastic or fluid concrete in its designated shape until it hardens. Access scaffolding is a temporary structure that functions as a work platform that supports construction personnel, materials, and tools, but is not intended to support the structure. Scaffolding systems that are used to temporarily support permanent structures (as opposed to functioning as work platforms) are considered to be falsework under the definitions given. Shoring is a component of falsework such as horizontal, vertical, or inclined support members. Where the term “temporary works” is used, it includes all of the temporary facilities used in bridge construction that do not become part of the permanent structure.

Design and construct safe and adequate temporary works that will support all loads imposed and provide the necessary rigidity to achieve the lines and grades shown on the plans in the final structure.

MATERIALS

Select materials suitable for temporary works; however, select materials that also ensure the safety and quality required by the design assumptions. The Engineer has authority to reject material on the basis of its condition, inappropriate use, safety, or nonconformance with the plans. Clearly identify allowable loads or stresses for all materials or manufactured devices on the plans. Revise the plan and notify the Engineer if any change to materials or material strengths is required.

DESIGN REQUIREMENTS**(A) Working Drawings**

Provide working drawings for items as specified in the contract, or as required by the Engineer, with design calculations and supporting data in sufficient detail to permit a structural and safety review of the proposed design of the temporary work.

On the drawings, show all information necessary to allow the design of any component to be checked independently as determined by the Engineer.

When concrete placement is involved, include data such as the drawings of proposed sequence, rate of placement, direction of placement, and location of all construction joints.

When required, have the drawings and calculations prepared under the guidance of, and sealed by, a North Carolina Registered Professional Engineer who is knowledgeable in temporary works design.

Project B-4654**ST-11****Wake County**

If requested by the Engineer, submit with the working drawings manufacturer's catalog data listing the weight of all construction equipment that will be supported on the temporary work. Show anticipated total settlements and/or deflections of falsework and forms on the working drawings. Include falsework footing settlements, joint take-up, and deflection of beams or girders.

As an option for the Contractor, overhang falsework hangers may be uniformly spaced, at a maximum of 36 inches, provided the following conditions are met:

Member Type (PCG)	Member Depth, (inches)	Max. Overhang Width, (inches)	Max. Slab Edge Thickness, (inches)	Max. Screed Wheel Weight, (lbs.)	Bracket Min. Vertical Leg Extension, (inches)
II	36	39	14	2000	26
III	45	42	14	2000	35
IV	54	45	14	2000	44
MBT	63	51	12	2000	50
MBT	72	55	12	1700	48

Overhang width is measured from the centerline of the girder to the edge of the deck slab. For Type II, III & IV prestressed concrete girders (PCG), 45-degree cast-in-place half hangers and rods must have a minimum safe working load of 6,000 lbs.

For MBT prestressed concrete girders, 45-degree angle holes for falsework hanger rods shall be cast through the girder top flange and located, measuring along the top of the member, 1'-2 1/2" from the edge of the top flange. Hanger hardware and rods must have a minimum safe working load of 6,000 lbs.

For link slabs, the top of girders directly beneath the link slab shall be free of overhang falsework attachments or other hardware. Submit calculations and working drawings for overhang falsework in the link slab region.

The overhang bracket provided for the diagonal leg shall have a minimum safe working load of 3,750 lbs. The vertical leg of the bracket shall extend to the point that the heel bears on the girder bottom flange, no closer than 4 inches from the bottom of the member. However, for 72-inch members, the heel of the bracket shall bear on the web, near the bottom flange transition.

Provide adequate overhang falsework and determine the appropriate adjustments for deck geometry, equipment, casting procedures and casting conditions.

If the optional overhang falsework spacing is used, indicate this on the falsework submittal and advise the girder producer of the proposed details. Failure to notify the Engineer of hanger type and hanger spacing on prestressed concrete girder casting drawings may delay the approval of those drawings.

Falsework hangers that support concentrated loads and are installed at the edge of thin top flange concrete girders (such as bulb tee girders) shall be spaced so as not to exceed 75% of the manufacturer's stated safe working load. Use of dual leg hangers (such as Meadow Burke HF-42 and HF-43) are not allowed on concrete girders with thin top flanges. Design the falsework and forms supporting deck slabs and overhangs on girder bridges so that there will be no differential settlement between the girders and the deck forms during placement of deck concrete.

When staged construction of the bridge deck is required, detail falsework and forms for screed and fluid concrete loads to be independent of any previous deck pour components when the mid-span girder deflection due to deck weight is greater than $\frac{3}{4}$ ".

Note on the working drawings any anchorages, connectors, inserts, steel sleeves or other such devices used as part of the falsework or formwork that remains in the permanent structure. If the plan notes indicate that the structure contains the necessary corrosion protection required for a Corrosive Site, epoxy coat, galvanize or metalize these devices. Electroplating will not be allowed. Any coating required by the Engineer will be considered incidental to the various pay items requiring temporary works.

Design falsework and formwork requiring submittals in accordance with the current edition of AASHTO *Guide Design Specifications for Bridge Temporary Works* except as noted herein.

(1) Wind Loads

Table 2.2 of Article 2.2.5.1 is modified to include wind velocities up to 110 mph. In addition, Table 2.2A is included to provide the maximum wind speeds by county in North Carolina.

Table 2.2 - Wind Pressure Values

Height Zone feet above ground	Pressure, lb/ft ² for Indicated Wind Velocity, mph				
	70	80	90	100	110
0 to 30	15	20	25	30	35
30 to 50	20	25	30	35	40
50 to 100	25	30	35	40	45
over 100	30	35	40	45	50

(2) Time of Removal

The following requirements replace those of Article 3.4.8.2.

Do not remove forms until the concrete has attained strengths required in Article 420-16 of the *Standard Specifications* and these Special Provisions.

Do not remove forms until the concrete has sufficient strength to prevent surface damage.

Table 2.2A - Steady State Maximum Wind Speeds by Counties in North Carolina

COUNTY	25 YR (mph)	COUNTY	25 YR (mph)	COUNTY	25 YR (mph)
Alamance	70	Franklin	70	Pamlico	100
Alexander	70	Gaston	70	Pasquotank	100
Alleghany	70	Gates	90	Pender	100
Anson	70	Graham	80	Perquimans	100
Ashe	70	Granville	70	Person	70
Avery	70	Greene	80	Pitt	90
Beaufort	100	Guilford	70	Polk	80
Bertie	90	Halifax	80	Randolph	70
Bladen	90	Harnett	70	Richmond	70
Brunswick	100	Haywood	80	Robeson	80
Buncombe	80	Henderson	80	Rockingham	70
Burke	70	Hertford	90	Rowan	70
Cabarrus	70	Hoke	70	Rutherford	70
Caldwell	70	Hyde	110	Sampson	90
Camden	100	Iredell	70	Scotland	70
Carteret	110	Jackson	80	Stanley	70
Caswell	70	Johnston	80	Stokes	70
Catawba	70	Jones	100	Surry	70
Cherokee	80	Lee	70	Swain	80
Chatham	70	Lenoir	90	Transylvania	80
Chowan	90	Lincoln	70	Tyrell	100
Clay	80	Macon	80	Union	70
Cleveland	70	Madison	80	Vance	70
Columbus	90	Martin	90	Wake	70
Craven	100	McDowell	70	Warren	70
Cumberland	80	Mecklenburg	70	Washington	100
Currituck	100	Mitchell	70	Watauga	70
Dare	110	Montgomery	70	Wayne	80
Davidson	70	Moore	70	Wilkes	70
Davie	70	Nash	80	Wilson	80
Duplin	90	New Hanover	100	Yadkin	70
Durham	70	Northampton	80	Yancey	70
Edgecombe	80	Onslow	100		
Forsyth	70	Orange	70		

Project B-4654**ST-14****Wake County****(B) Review and Approval**

The Engineer is responsible for the review and approval of temporary works' drawings.

Submit the working drawings sufficiently in advance of proposed use to allow for their review, revision (if needed), and approval without delay to the work.

The time period for review of the working drawings does not begin until complete drawings and design calculations, when required, are received by the Engineer.

Do not start construction of any temporary work for which working drawings are required until the drawings have been approved. Such approval does not relieve the Contractor of the responsibility for the accuracy and adequacy of the working drawings.

CONSTRUCTION REQUIREMENTS

All requirements of Section 420 of the *Standard Specifications* apply.

Construct temporary works in conformance with the approved working drawings. Ensure that the quality of materials and workmanship employed is consistent with that assumed in the design of the temporary works. Do not weld falsework members to any portion of the permanent structure unless approved. Show any welding to the permanent structure on the approved construction drawings.

Provide tell-tales attached to the forms and extending to the ground, or other means, for accurate measurement of falsework settlement. Make sure that the anticipated compressive settlement and/or deflection of falsework does not exceed 1 inch. For cast-in-place concrete structures, make sure that the calculated deflection of falsework flexural members does not exceed 1/240 of their span regardless of whether or not the deflection is compensated by camber strips.

(A) Maintenance and Inspection

Inspect and maintain the temporary work in an acceptable condition throughout the period of its use. Certify that the manufactured devices have been maintained in a condition to allow them to safely carry their rated loads. Clearly mark each piece so that its capacity can be readily determined at the job site.

Perform an in-depth inspection of an applicable portion(s) of the temporary works, in the presence of the Engineer, not more than 24 hours prior to the beginning of each concrete placement. Inspect other temporary works at least once a month to ensure that they are functioning properly. Have a North Carolina Registered Professional Engineer inspect the cofferdams, shoring, sheathing, support of excavation structures, and support systems for load tests prior to loading.

Project B-4654

ST-15

Wake County

(B) Foundations

Determine the safe bearing capacity of the foundation material on which the supports for temporary works rest. If required by the Engineer, conduct load tests to verify proposed bearing capacity values that are marginal or in other high-risk situations.

The use of the foundation support values shown on the contract plans of the permanent structure is permitted if the foundations are on the same level and on the same soil as those of the permanent structure.

Allow for adequate site drainage or soil protection to prevent soil saturation and washout of the soil supporting the temporary works supports.

If piles are used, the estimation of capacities and later confirmation during construction using standard procedures based on the driving characteristics of the pile is permitted. If preferred, use load tests to confirm the estimated capacities; or, if required by the Engineer conduct load tests to verify bearing capacity values that are marginal or in other high risk situations.

The Engineer reviews and approves the proposed pile and soil bearing capacities.

REMOVAL

Unless otherwise permitted, remove and keep all temporary works upon completion of the work. Do not disturb or otherwise damage the finished work.

Remove temporary works in conformance with the contract documents. Remove them in such a manner as to permit the structure to uniformly and gradually take the stresses due to its own weight.

MEASUREMENT AND PAYMENT

Unless otherwise specified, *Falsework and Formwork* will not be directly measured.

Payment at the contract unit prices for the various pay items requiring temporary works will be full compensation for the above falsework and formwork.

Project B-4654**ST-16****Wake County****SUBMITTAL OF WORKING DRAWINGS****(11-30-23)****GENERAL**

Submit working drawings in accordance with Article 105-2 of the *Standard Specifications* and this Special Provision. For this Special Provision, “submittals” refers to only those listed in this Special Provision. The list of submittals contained herein does not represent a list of required submittals for the project. Submittals are only necessary for those items as required by the contract. Make submittals that are not specifically noted in this provision directly to the Engineer. Either the Structures Management Unit or the Geotechnical Engineering Unit or both units will jointly review submittals.

If a submittal contains variations from plan details or specifications or significantly affects project cost, field construction or operations, discuss the submittal with and submit all copies to the Engineer. State the reason for the proposed variation in the submittal. To minimize review time, make sure all submittals are complete when initially submitted. Provide a contact name and information with each submittal. Direct any questions regarding submittal requirements to the Engineer, Structures Management Unit contacts or the Geotechnical Engineering Unit contacts noted below.

To facilitate in-plant inspection by NCDOT and approval of working drawings, provide the name, address and telephone number of the facility where fabrication will actually be done if different than shown on the title block of the submitted working drawings. This includes, but is not limited to, precast concrete items, prestressed concrete items and fabricated steel or aluminum items.

ADDRESSES AND CONTACTS

For submittals to the Structures Management Unit, use the following addresses:

Via Email: SMU-wdr@ncdot.gov (do not cc SMU Working Drawings staff)

Via US mail:

Mr. B. C. Hanks, P. E.
State Structures Engineer
North Carolina Department
of Transportation
Structures Management Unit
1581 Mail Service Center
Raleigh, NC 27699-1581

Attention: Mr. J. L. Bolden, P. E.

Via other delivery service:

Mr. B. C. Hanks, P. E.
State Structures Engineer
North Carolina Department
of Transportation
Structures Management Unit
1000 Birch Ridge Drive
Raleigh, NC 27610

Attention: Mr. J. L. Bolden, P. E.

For submittals to the Geotechnical Engineering Unit, use the following addresses:

For projects in Divisions 1-7, use the following Eastern Regional Office addresses:

Project B-4654

ST-17

Wake County

Via Email: EastGeotechnicalSubmittal@ncdot.gov

Via US mail:

Mr. Thomas Santee, P. E.
Assistant State Geotechnical
Engineer – Eastern Region
North Carolina Department
of Transportation
Geotechnical Engineering Unit
Eastern Regional Office
1570 Mail Service Center
Raleigh, NC 27699-1570

Via other delivery service:

Mr. Thomas Santee, P. E.
Assistant State Geotechnical
Engineer – Eastern Region
North Carolina Department
of Transportation
Geotechnical Engineering Unit
Eastern Regional Office
3301 Jones Sausage Road, Suite 100
Garner, NC 27529

For projects in Divisions 8-14, use the following Western Regional Office addresses:

Via Email: WestGeotechnicalSubmittal@ncdot.gov

Via US mail or other delivery service:

Mr. Eric Williams, P. E.
Assistant State Geotechnical
Engineer – Western Region
North Carolina Department
of Transportation
Geotechnical Engineering Unit
Western Regional Office
5253 Z Max Boulevard
Harrisburg, NC 28075

The status of the review of structure-related submittals sent to the Structures Management Unit can be viewed from the Unit’s website, via the “[Drawing Submittal Status](#)” link.

The status of the review of geotechnical-related submittals sent to the Geotechnical Engineering Unit can be viewed from the Unit’s website, via the “[Geotechnical Construction Submittals](#)” link.

Direct any questions concerning submittal review status, review comments or drawing markups to the following contacts:

Primary Structures Contact: James Bolden (919) 707 – 6408
jlbolden@ncdot.gov

Secondary Structures Contacts: Emmanuel Omile (919) 707 – 6451
eomile@ncdot.gov

Madonna Rorie (919) 707 – 6508
mrorie@ncdot.gov

Project B-4654**ST-18****Wake County**

Eastern Regional Geotechnical Contact (Divisions 1-7):

Thomas Santee (919) 920-8901

tgsantee@ncdot.gov

Western Regional Geotechnical Contact (Divisions 8-14):

Eric Williams (704) 455 – 8902

ewilliams3@ncdot.gov**SUBMITTAL COPIES**

Furnish one complete copy of each submittal, including all attachments, to the Engineer. At the same time, submit a copy of the same complete submittal directly to the Structures Management Unit and/or the Geotechnical Engineering Unit as specified in the tables below.

The first table below covers “Structure Submittals.” The Engineer will receive review comments and drawing markups for these submittals from the Structures Management Unit. The second table in this section covers “Geotechnical Submittals.” The Engineer will receive review comments and drawing markups for these submittals from the Geotechnical Engineering Unit.

Unless otherwise required, submit one set of supporting calculations to either the Structures Management Unit or the Geotechnical Engineering Unit unless both units require submittal copies in which case submit a set of supporting calculations to each unit. Provide additional copies of any submittal as directed.

STRUCTURE SUBMITTALS

Submittal	Submittal Required by Structures Management Unit?	Submittal Required by Geotechnical Engineering Unit?	Contract Reference Requiring Submittal ¹
Arch Culvert Falsework	Y	N	Plan Note, SN Sheet & “Falsework and Formwork”
Box Culvert Falsework ⁷	Y	N	Plan Note, SN Sheet & “Falsework and Formwork”
Cofferdams	Y	Y	Article 410-4
Foam Joint Seals ⁶	Y	N	“Foam Joint Seals”
Expansion Joint Seals (hold down plate type with base angle)	Y	N	“Expansion Joint Seals”
Expansion Joint Seals (modular)	Y	N	“Modular Expansion Joint Seals”

Project B-4654**ST-19****Wake County**

Expansion Joint Seals (strip seals)	Y	N	“Strip Seal Expansion Joints”
Falsework & Forms ² (substructure)	Y	N	Article 420-3 & “Falsework and Formwork”
Falsework & Forms (superstructure)	Y	N	Article 420-3 & “Falsework and Formwork”
Girder Erection over Railroad	Y	N	Railroad Provisions
Maintenance and Protection of Traffic Beneath Proposed Structure	Y	N	“Maintenance and Protection of Traffic Beneath Proposed Structure at Station ____”
Metal Bridge Railing	Y	N	Plan Note
Metal Stay-in-Place Forms	Y	N	Article 420-3
Metalwork for Elastomeric Bearings ^{4,5}	Y	N	Article 1072-8
Miscellaneous Metalwork ^{4,5}	Y	N	Article 1072-8
Disc Bearings ⁴	Y	N	“Disc Bearings”
Overhead and Digital Message Signs (DMS) (metalwork and foundations)	Y	N	Applicable Provisions
Placement of Equipment on Structures (cranes, etc.)	Y	N	Article 420-20
Prestressed Concrete Box Beam (detensioning sequences) ³	Y	N	Article 1078-11
Precast Concrete Box Culverts	Y	N	“Optional Precast Reinforced Concrete Box Culvert at Station ____”
Prestressed Concrete Cored Slab (detensioning sequences) ³	Y	N	Article 1078-11
Prestressed Concrete Deck Panels	Y	N	Article 420-3
Prestressed Concrete Girder (strand elongation and detensioning sequences)	Y	N	Articles 1078-8 and 1078- 11
Removal of Existing Structure over Railroad	Y	N	Railroad Provisions

Project B-4654**ST-20****Wake County**

Revised Bridge Deck Plans (adaptation to prestressed deck panels)	Y	N	Article 420-3
Revised Bridge Deck Plans (adaptation to modular expansion joint seals)	Y	N	“Modular Expansion Joint Seals”
Sound Barrier Wall (precast items)	Y	N	Article 1077-2 & “Sound Barrier Wall”
Sound Barrier Wall Steel Fabrication Plans ⁵	Y	N	Article 1072-8 & “Sound Barrier Wall”
Structural Steel ⁴	Y	N	Article 1072-8
Temporary Detour Structures	Y	Y	Article 400-3 & “Construction, Maintenance and Removal of Temporary Structure at Station _____”
TFE Expansion Bearings ⁴	Y	N	Article 1072-8

FOOTNOTES

- References are provided to help locate the part of the contract where the submittals are required. References in quotes refer to the provision by that name. Articles refer to the *Standard Specifications*.
- Submittals for these items are necessary only when required by a note on plans.
- Submittals for these items may not be required. A list of pre-approved sequences is available from the producer or the Materials & Tests Unit.
- The fabricator may submit these items directly to the Structures Management Unit.
- The two sets of preliminary submittals required by Article 1072-8 of the *Standard Specifications* are not required for these items.
- Submittals for Fabrication Drawings are not required. Submittals for Catalogue Cuts of Proposed Material are required. See Section 5.A of the referenced provision.
- Submittals are necessary only when the top slab thickness is 18” or greater.

Project B-4654

ST-21

Wake County

GEOTECHNICAL SUBMITTALS

Submittal	Submittals Required by Geotechnical Engineering Unit	Submittals Required by Structures Management Unit	Contract Reference Requiring Submittal ¹
Drilled Pier Construction Plans ²	Y	N	Subarticle 411-3(A)
Crosshole Sonic Logging (CSL) Reports ²	Y	N	Subarticle 411-5(A)(2)
Pile Driving Equipment Data Forms ^{2,3}	Y	N	Subarticle 450-3(D)(2)
Pile Driving Analyzer (PDA) Reports ²	Y	N	Subarticle 450-3(F)(3)
Retaining Walls ⁴	Y; drawings and calculations	Y; drawings	Applicable Provisions
Temporary Shoring ⁴	Y; drawings and calculations	Y; drawings	“Temporary Shoring” & “Temporary Soil Nail Walls”

FOOTNOTES

- References are provided to help locate the part of the contract where the submittals are required. References in quotes refer to the provision by that name. Subarticles refer to the *Standard Specifications*.
- Submit one hard copy of submittal to the Engineer. Submit a second copy of submittal electronically (PDF via email), US mail or other delivery service to the appropriate Geotechnical Engineering Unit regional office. Electronic submission is preferred.
- The Pile Driving Equipment Data Form is available from:
<https://connect.ncdot.gov/projects/construction/ConstManRefDocs/PILE%20DRIVING%20EQUIPMENT%20DATA%20FORM.pdf>
See second page of form for submittal instructions.
- Electronic copy of submittal is required. See referenced provision.

Project B-4654**ST-22****Wake County****CRANE SAFETY****(6-20-19)****GENERAL**

Comply with the manufacturer specifications and limitations applicable to the operation of any and all cranes and derricks. Prime contractors, sub-contractors, and fully operated rental companies shall comply with the current Occupational Safety and Health Administration (OSHA) regulations.

Submit all items listed below to the Engineer prior to beginning crane operations. Changes in personnel or equipment must be reported to the Engineer and all applicable items listed below must be updated and submitted prior to continuing with crane operations.

CRANE SAFETY SUBMITTAL LIST

- (A) **Competent Person:** Provide the name and qualifications of the “Competent Person” responsible for crane safety and lifting operations. The named competent person will have the responsibility and authority to stop any work activity due to safety concerns.
- (B) **Riggers:** Provide the qualifications and experience of the persons responsible for rigging operations. Qualifications and experience should include, but not be limited to, weight calculations, center of gravity determinations, selection and inspection of sling and rigging equipment, and safe rigging practices.
- (C) **Crane Inspections:** Inspection records for all cranes shall be current and readily accessible for review upon request.
- (D) **Certifications:** Crane operators shall be certified by the National Commission for the Certification of Crane Operators (NCCCO) or the National Center for Construction Education and Research (NCCER). Other approved nationally accredited programs will be considered upon request. In addition, crane operators shall have a current CDL medical card. Submit a list of crane operator(s) and include current certification for each type of crane operated (small hydraulic, large hydraulic, small lattice, large lattice) and medical evaluations for each operator.

MEASUREMENT AND PAYMENT

No direct payment will be made for *Crane Safety*. All costs shall be considered incidental to items for which direct payment is made.

Project B-4654**ST-23****Wake County****GROUT FOR STRUCTURES****(12-1-17)****GENERAL**

This Special Provision addresses grout for use in pile blockouts, grout pockets, shear keys, dowel holes and recesses for structures. This Special Provision does not apply to grout placed in post-tensioning ducts for bridge beams, girders, decks, end bent caps, or bent caps. Mix and place grout in accordance with the manufacturer's recommendations, the applicable sections of the *Standard Specifications* and this Special Provision.

MATERIAL REQUIREMENT

Unless otherwise noted on the plans, use a Type 3 Grout in accordance with Section 1003 of the *Standard Specifications*.

Initial setting time shall not be less than 10 minutes when tested in accordance with ASTM C266.

Construction loading and traffic loading shall not be allowed until the 3-day compressive strength is achieved.

SAMPLING AND PLACEMENT

Place and maintain components in final position until grout placement is complete and accepted. Concrete surfaces to receive grout shall be free of defective concrete, laitance, oil, grease, and other foreign matter. Saturate concrete surfaces with clean water and remove excess water prior to placing grout.

MEASUREMENT AND PAYMENT

No separate payment will be made for *Grout for Structures*. The cost of the material, equipment, labor, placement, and any incidentals necessary to complete the work shall be considered incidental to the structure item requiring grout.

Project B-4654**ST-24****Wake County****ASBESTOS ASSESSMENT****(11-30-23)****INSPECTION FOR ASBESTOS CONTAINING MATERIAL**

Prior to conducting bridge demolition or renovation activities, the Contractor shall thoroughly inspect the bridge or affected components for the presence of asbestos containing material (ACM) using a firm prequalified by NCDOT to perform asbestos surveys. The inspection must be performed by a N.C. accredited asbestos inspector with experience inspecting bridges or other industrial structures. The N.C. accredited asbestos inspector must conduct a thorough inspection, identifying all asbestos-containing material as required by the Environmental Protection Agency National Emission Standards for Hazardous Air Pollutants (NESHAP) Code of Federal Regulations (CFR) 40 CFR, Part 61, Subpart M.

The Contractor shall submit an inspection report to the Engineer, which at a minimum must include information required in 40 CFR 763.85 (a)(4) vi)(A)-(E), as well as a project location map, photos of existing structure, the date of inspection and the name, N.C. accreditation number, and signature of the N.C. accredited asbestos inspector who performed the inspection and completed the report. The cover sheet of the report shall include project identification information. Place the following notes on the cover sheet of the report and check the appropriate box:

- ACM was found
 ACM was not found

REMOVAL AND DISPOSAL OF ASBESTOS CONTAINING MATERIAL

If ACM is found, notify the Engineer. Compensation for removal and disposal of ACM is considered extra work in accordance with Article 104-7 of the *Standard Specifications*.

An Asbestos Removal Permit must be obtained from the Health Hazards Control Unit (HHCU) of the N.C. Department of Health & Human Services, Division of Public Health, if more than 35 cubic feet, 160 square feet, or 260 linear feet of regulated ACM (RACM) is to be removed from a structure and this work must be completed by a contractor prequalified by NCDOT to perform asbestos abatement. RACM is defined in 40 CFR, Part 61, Subpart M. Note: 40 CFR 763.85 (a)(4) vi)(D) defines ACM as surfacing, TSI and Miscellaneous which does not meet the NESHAP RACM.

DEMOLITION NOTIFICATION

Even if no ACM is found (or if quantities are less than those required for a permit), a Demolition Notification (DHHS-3768) must be submitted to the HHCU. Notifications and Asbestos Permit applications require an original signature and must be submitted to the HHCU 10 working days prior to beginning demolition activities. The 10 working day period starts based on the post-marked date or date of hand delivery. Demolition that does not begin as originally notified requires submission of a separate revision form HHCU 3768-R to HHCU. Reference the North Carolina Administrative Code, Chapter 10A, Subchapter 41C, Article .0605 for directives on revision submissions.

Project B-4654

ST-25

Wake County

Contact Information

Health Hazards Control Unit (HHCU)
N.C. Department of Health and Human Services
1912 Mail Service Center
Raleigh, NC 27699-1912
Telephone: (919) 707-5950
Fax: (919) 870-4808

SPECIAL CONSIDERATIONS

Buncombe, Forsyth, and Mecklenburg counties also have asbestos permitting and NESHAP requirements must be followed. For projects involving permitted RACM removals, both the applicable county and the state (HHCU) must be notified.

For demolitions with no RACM, only the local environmental agencies must be notified. Contact information is as follows:

Buncombe County

WNC Regional Air Pollution Control Agency
49 Mt. Carmel Road
Asheville, NC 28806
(828) 250-6777

Forsyth County

Environmental Affairs Department
537 N. Spruce Street
Winston-Salem, NC 27101
(336) 703-2440

Mecklenburg County

Land Use and Environmental Services Agency
Mecklenburg Air Quality
700 N. Tryon Street
Charlotte, NC 28202
(704) 336-5430

ADDITIONAL INFORMATION

Additional information may be found on N.C. asbestos rules, regulations, procedures, and N.C. accredited inspectors, as well as associated forms for demolition notifications and asbestos permit applications at the N.C. Asbestos Hazard Management Program website:

<https://epi.dph.ncdhhs.gov/asbestos/ahmp.html>

Project B-4654

ST-26

Wake County

MEASUREMENT AND PAYMENT

Asbestos Assessment Payment will be paid at the lump sum contract unit price and will be full compensation for all asbestos inspections, reports, permitting and notifications.

Payment will be made under:

Pay Item

Asbestos Assessment

Pay Unit

Lump Sum

Project B-4654**ST-27****Wake County****CLASSIC CONCRETE BRIDGE RAILS****(SPECIAL)****General**

The "Classic Concrete Bridge Rail" shall be in accordance with applicable parts of the Standard Specifications, the details shown on the plans and as outlined in these special provisions. Plans for the bridge rails are detailed for cast in place concrete and must be placed using conventional forms.

Concrete Mix

Concrete for the bridge rail shall meet the requirements for class AA concrete with exception noted below:

The maximum size coarse aggregate used in the concrete mix shall be #78M. The slump shall be within the range of 5" to 8" when tested in accordance with AASHTO T119. A high range water reducer shall be used. The quantity of high range water reducer per pound of cement shall be within the range recommended on the current list of approved admixtures issued by M&T Unit.

Construction

The bridge rails shall be placed to the established shape, line, grade and dimensions shown on the plans.

Joints in the rails shall be constructed at the locations and of the type specified on the plans.

Finishing

All exposed surfaces which are not satisfactory to the Engineer as to uniformity of color and texture or because of excessive patching shall be corrected as required by the Engineer. All surfaces of the bridge rails shall be given a Class I surface finish in accordance with the Standard Specifications unless directed otherwise by the Engineer.

Measurement

The quantity to be paid for under this item shall be the actual number of linear feet of "Classic Concrete Bridge Rail", complete in place and accepted, measured continuously along the top surface of completed rail from end to end without deductions for spaces between sections.

Payment

The quantity, measured as described above, will be paid for at the contract unit price per linear foot bid for "Classic Concrete Bridge Rail", which price and payment shall be full compensation for all materials, admixtures, forms, falsework, curing, surface finish, tools, labor, equipment and incidentals necessary to complete the item.

PROJECT SPECIAL PROVISION

(10-18-95) (Rev. 9-19-23)

Z-1

PERMITS

The Contractor's attention is directed to the following permits, which have been issued to the Department of Transportation by the authority granting the permit.

<u>PERMIT</u>	<u>AUTHORITY GRANTING THE PERMIT</u>
Dredge and Fill and/or Work in Navigable Waters (404)	U. S. Army Corps of Engineers
Water Quality (401)	Division of Environmental Management, DEQ State of North Carolina

The Contractor shall comply with all applicable permit conditions during construction of this project.

Agents of the permitting authority will periodically inspect the project for adherence to the permits.

The Contractor's attention is also directed to Articles 107-10 and 107-13 of the *Standard Specifications* and the following:

Should the Contractor propose to utilize construction methods (such as temporary structures or fill in waters and/or wetlands for haul roads, work platforms, cofferdams, etc.) not specifically identified in the permit (individual, general, or nationwide) authorizing the project it shall be the Contractor's responsibility to coordinate with the Engineer to determine what, if any, additional permit action is required. The Contractor shall also be responsible for initiating the request for the authorization of such construction method by the permitting agency. The request shall be submitted through the Engineer. The Contractor shall not utilize the construction method until it is approved by the permitting agency. The request normally takes approximately 60 days to process; however, no extensions of time or additional compensation will be granted for delays resulting from the Contractor's request for approval of construction methods not specifically identified in the permit.

Where construction moratoriums are contained in a permit condition which restricts the Contractor's activities to certain times of the year, those moratoriums will apply only to the portions of the work taking place in the restricted waters, wetlands or buffer zones, provided that activities outside those areas is done in such a manner as to not affect the restricted waters, wetlands or buffer zones.



STATE OF NORTH CAROLINA
DEPARTMENT OF TRANSPORTATION

ROY COOPER
GOVERNOR

J. ERIC BOYETTE
SECRETARY

May 31, 2022

MEMORANDUM TO: Mr. Brandon Jones, P.E., Division Engineer
Division 5

DocuSigned by:
Mack C. Rivenbark III
AAAD1248B309416...

FROM: for Philip S. Harris, III, P.E., C.P.M, Unit Head
Environmental Analysis Unit

SUBJECT: Environmental Permits for the replacement of Bridge No. 69 on NC 50
over US 70 in Wake County. WBS No. 38454.1.2
STIP B-4654.

Please find enclosed the following permits for this project:

Agency	Permit Type	Permit Expiration
US Army Corps of Engineers Section 404 Clean Water Act	Nationwide Permit 3	March 14, 2026
NC Division of Water Resources Section 401 Clean Water Act	General Certification No. 4239 [NWP 3]	March 14, 2026

Please feel free to contact our Unit for any questions.

ec:
NCDOT Permit Website (<https://xfer.services.ncdot.gov/pdea/PermIssued/>)



STATE OF NORTH CAROLINA
DEPARTMENT OF TRANSPORTATION

ROY COOPER
GOVERNOR

J. ERIC BOYETTE
SECRETARY

DATE: March 16, 2022

TO: File

FROM: Deanna Riffey, Environmental Program Consultant
Environmental Analysis Unit

SUBJECT: B-4654 Section 404 Nationwide Permit 3 and Section 401 General Water Quality Certification

Per email correspondence with U.S. Army Corps of Engineers (USACE) Regulatory Specialist James Lastinger on February 25, 2019, a Nationwide Permit 3 is applicable for the jurisdictional impacts associated with this project. Under the current design, neither written notifications nor written concurrences from the USACE or the N.C. Division of Water Resources (NCDWR) are required. Due to the minimal impacts (10 linear feet permanent and 10 linear feet temporary) to an unnamed tributary to Reedy Branch, mitigation is not proposed. NCDOT must comply with all conditions and descriptions in the attached Permit Drawings, 404 General Conditions, and 401 Standard Conditions. A permit modification may be required if any of the above conditions and descriptions cannot be met.

Mailing Address:
NC DEPARTMENT OF TRANSPORTATION
ENVIRONMENTAL ANALYSIS UNIT
1598 MAIL SERVICE CENTER
RALEIGH, NC 27699-1598

Telephone: (919) 707-6000
Customer Service: 1-877-368-4968
Website: www.ncdot.gov

Location:
1000 BIRCH RIDGE DRIVE
RALEIGH, NC 27699

P-4

Nationwide Permit 3 **Maintenance**

Effective Date: February 25, 2022 / Expiration Date: March 14, 2026

Authority: Sections 10 and 404

(a) The repair, rehabilitation, or replacement of any previously authorized, currently serviceable structure or fill, or of any currently serviceable structure or fill authorized by 33 CFR 330.3, provided that the structure or fill is not to be put to uses differing from those uses specified or contemplated for it in the original permit or the most recently authorized modification. Minor deviations in the structure's configuration or filled area, including those due to changes in materials, construction techniques, requirements of other regulatory agencies, or current construction codes or safety standards that are necessary to make the repair, rehabilitation, or replacement are authorized. This NWP also authorizes the removal of previously authorized structures or fills. Any stream channel modification is limited to the minimum necessary for the repair, rehabilitation, or replacement of the structure or fill; such modifications, including the removal of material from the stream channel, must be immediately adjacent to the project. This NWP also authorizes the removal of accumulated sediment and debris within, and in the immediate vicinity of, the structure or fill. This NWP also authorizes the repair, rehabilitation, or replacement of those structures or fills destroyed or damaged by storms, floods, fire or other discrete events, provided the repair, rehabilitation, or replacement is commenced, or is under contract to commence, within two years of the date of their destruction or damage. In cases of catastrophic events, such as hurricanes or tornadoes, this two-year limit may be waived by the district engineer, provided the permittee can demonstrate funding, contract, or other similar delays.

(b) This NWP also authorizes the removal of accumulated sediments and debris outside the immediate vicinity of existing structures (e.g., bridges, culverted road crossings, water intake structures, etc.). The removal of sediment is limited to the minimum necessary to restore the waterway in the vicinity of the structure to the approximate dimensions that existed when the structure was built but cannot extend farther than 200 feet in any direction from the structure. This 200-foot limit does not apply to maintenance dredging to remove accumulated sediments blocking or restricting outfall and intake structures or to maintenance dredging to remove accumulated sediments from canals associated with outfall and intake structures. All dredged or excavated materials must be deposited and retained in an area that has no waters of the United States unless otherwise specifically approved by the district engineer under separate authorization.

(c) This NWP also authorizes temporary structures, fills, and work, including the use of temporary mats, necessary to conduct the maintenance activity. Appropriate measures must be taken to maintain normal downstream flows and minimize flooding to the maximum extent practicable, when temporary structures, work, and discharges of dredged or fill material, including cofferdams, are necessary for construction activities, access fills, or dewatering of construction sites. Temporary fills must consist of materials, and be placed in a manner, that will not be eroded by expected high flows. After conducting the maintenance activity, temporary fills must be removed in their entirety and the affected areas returned to pre-construction elevations. The areas affected by temporary fills must be revegetated, as appropriate.

(d) This NWP does not authorize maintenance dredging for the primary purpose of navigation. This NWP does not authorize beach restoration. This NWP does not authorize new stream channelization or stream relocation projects.

P-5

Nationwide Permit 3 - Activities, Regional Conditions, General Conditions, and Definitions

Notification: For activities authorized by paragraph (b) of this NWP, the permittee must submit a pre-construction notification to the district engineer prior to commencing the activity (see general condition 32). The pre-construction notification must include information regarding the original design capacities and configurations of the outfalls, intakes, small impoundments, and canals. (Authorities: Section 10 of the Rivers and Harbors Act of 1899 and Section 404 of the Clean Water Act (Sections 10 and 404))

Note: This NWP authorizes the repair, rehabilitation, or replacement of any previously authorized structure or fill that does not qualify for the Clean Water Act Section 404(f) exemption for maintenance.

GENERAL CONDITIONS

Note: To qualify for NWP authorization, the prospective permittee must comply with the following general conditions, as applicable, in addition to any regional or case-specific conditions imposed by the division engineer or district engineer. Prospective permittees should contact the appropriate Corps district office to determine if regional conditions have been imposed on an NWP. Prospective permittees should also contact the appropriate Corps district office to determine the status of Clean Water Act Section 401 water quality certification and/or Coastal Zone Management Act consistency for an NWP. Every person who may wish to obtain permit authorization under one or more NWPs, or who is currently relying on an existing or prior permit authorization under one or more NWPs, has been and is on notice that all of the provisions of 33 CFR 330.1 through 330.6 apply to every NWP authorization. Note especially 33 CFR 330.5 relating to the modification, suspension, or revocation of any NWP authorization.

1. Navigation.

(a) No activity may cause more than a minimal adverse effect on navigation.

(b) Any safety lights and signals prescribed by the U.S. Coast Guard, through regulations or otherwise, must be installed and maintained at the permittee's expense on authorized facilities in navigable waters of the United States.

(c) The permittee understands and agrees that, if future operations by the United States require the removal, relocation, or other alteration, of the structure or work herein authorized, or if, in the opinion of the Secretary of the Army or his authorized representative, said structure or work shall cause unreasonable obstruction to the free navigation of the navigable waters, the permittee will be required, upon due notice from the Corps of Engineers, to remove, relocate, or alter the structural work or obstructions caused thereby, without expense to the United States. No claim shall be made against the United States on account of any such removal or alteration.

2. Aquatic Life Movements. No activity may substantially disrupt the necessary life cycle movements of those species of aquatic life indigenous to the waterbody, including those species that normally migrate through the area, unless the activity's primary purpose is to impound water. All permanent and temporary crossings of waterbodies shall be suitably culverted, bridged, or otherwise designed and constructed to maintain low flows to sustain the movement of those aquatic species. If a bottomless culvert cannot be used, then the crossing should be designed and constructed to minimize adverse effects to aquatic life movements.

P-6

Nationwide Permit 3 - Activities, Regional Conditions, General Conditions, and Definitions

3. **Spawning Areas.** Activities in spawning areas during spawning seasons must be avoided to the maximum extent practicable. Activities that result in the physical destruction (e.g., through excavation, fill, or downstream smothering by substantial turbidity) of an important spawning area are not authorized.

4. **Migratory Bird Breeding Areas.** Activities in waters of the United States that serve as breeding areas for migratory birds must be avoided to the maximum extent practicable.

5. **Shellfish Beds.** No activity may occur in areas of concentrated shellfish populations, unless the activity is directly related to a shellfish harvesting activity authorized by NWP 4 and 48, or is a shellfish seeding or habitat restoration activity authorized by NWP 27.

6. **Suitable Material.** No activity may use unsuitable material (e.g., trash, debris, car bodies, asphalt, etc.). Material used for construction or discharged must be free from toxic pollutants in toxic amounts (see section 307 of the Clean Water Act).

7. **Water Supply Intakes.** No activity may occur in the proximity of a public water supply intake, except where the activity is for the repair or improvement of public water supply intake structures or adjacent bank stabilization.

8. **Adverse Effects from Impoundments.** If the activity creates an impoundment of water, adverse effects to the aquatic system due to accelerating the passage of water, and/or restricting its flow must be minimized to the maximum extent practicable.

9. **Management of Water Flows.** To the maximum extent practicable, the pre-construction course, condition, capacity, and location of open waters must be maintained for each activity, including stream channelization, storm water management activities, and temporary and permanent road crossings, except as provided below. The activity must be constructed to withstand expected high flows. The activity must not restrict or impede the passage of normal or high flows unless the primary purpose of the activity is to impound water or manage high flows. The activity may alter the pre-construction course, condition, capacity, and location of open waters if it benefits the aquatic environment (e.g., stream restoration or relocation activities).

10. **Fills Within 100-Year Floodplains.** The activity must comply with applicable FEMA-approved state or local floodplain management requirements.

11. **Equipment.** Heavy equipment working in wetlands or mudflats must be placed on mats, or other measures must be taken to minimize soil disturbance.

12. **Soil Erosion and Sediment Controls.** Appropriate soil erosion and sediment controls must be used and maintained in effective operating condition during construction, and all exposed soil and other fills, as well as any work below the ordinary high water mark or high tide line, must be permanently stabilized at the earliest practicable date. Permittees are encouraged to perform work within waters of the United States during periods of low-flow or no-flow, or during low tides.

13. **Removal of Structures and Fills.** Temporary structures must be removed, to the maximum extent practicable, after their use has been discontinued. Temporary fills must be removed in their entirety and the affected areas returned to pre-construction elevations. The affected areas must be revegetated, as appropriate.

14. **Proper Maintenance.** Any authorized structure or fill shall be properly maintained, including maintenance to ensure public safety and compliance with applicable NWP general conditions, as well as any activity-specific conditions added by the district engineer to an NWP authorization.

15. **Single and Complete Project.** The activity must be a single and complete project. The same NWP cannot be used more than once for the same single and complete project.

16. **Wild and Scenic Rivers.**

(a) No NWP activity may occur in a component of the National Wild and Scenic River System, or in a river officially designated by Congress as a “study river” for possible inclusion in the system while the river is in an official study status, unless the appropriate Federal agency with direct management responsibility for such river, has determined in writing that the proposed activity will not adversely affect the Wild and Scenic River designation or study status.

(b) If a proposed NWP activity will occur in a component of the National Wild and Scenic River System, or in a river officially designated by Congress as a “study river” for possible inclusion in the system while the river is in an official study status, the permittee must submit a pre-construction notification (see general condition 32). The district engineer will coordinate the PCN with the Federal agency with direct management responsibility for that river. Permittees shall not begin the NWP activity until notified by the district engineer that the Federal agency with direct management responsibility for that river has determined in writing that the proposed NWP activity will not adversely affect the Wild and Scenic River designation or study status.

(c) Information on Wild and Scenic Rivers may be obtained from the appropriate Federal land management agency responsible for the designated Wild and Scenic River or study river (e.g., National Park Service, U.S. Forest Service, Bureau of Land Management, U.S. Fish and Wildlife Service). Information on these rivers is also available at: <http://www.rivers.gov/>.

17. **Tribal Rights.** No activity or its operation may impair reserved tribal rights, including, but not limited to, reserved water rights and treaty fishing and hunting rights.

18. **Endangered Species.**

(a) No activity is authorized under any NWP which is likely to directly or indirectly jeopardize the continued existence of a threatened or endangered species or a species proposed for such designation, as identified under the Federal Endangered Species Act (ESA), or which will directly or indirectly destroy or adversely modify the critical habitat of such species. No activity is authorized under any NWP which “may affect” a listed species or critical habitat unless ESA section 7 consultation addressing the consequences of the proposed activity on listed species or critical habitat has been completed. See 50 CFR 402.02 for the definition of “effects of the action” for the purposes of ESA section 7 consultation, as well as 50 CFR 402.17, which provides further explanation under ESA section 7 regarding “activities that are reasonably certain to occur” and “consequences caused by the proposed action.”

(b) Federal agencies should follow their own procedures for complying with the requirements of the ESA (see 33 CFR 330.4(f)(1)). If pre-construction notification is required for the proposed activity, the Federal permittee must provide the district engineer with the appropriate documentation to demonstrate compliance with those requirements. The district engineer will verify that the appropriate documentation has been submitted. If the appropriate documentation has not been submitted, additional ESA section 7 consultation may be

P-8

necessary for the activity and the respective federal agency would be responsible for fulfilling its obligation under section 7 of the ESA.

(c) Non-federal permittees must submit a pre-construction notification to the district engineer if any listed species or designated critical habitat might be affected or is in the vicinity of the activity, or if the activity is located in designated critical habitat, and shall not begin work on the activity until notified by the district engineer that the requirements of the ESA have been satisfied and that the activity is authorized. For activities that might affect Federally-listed endangered or threatened species or designated critical habitat, the pre-construction notification must include the name(s) of the endangered or threatened species that might be affected by the proposed activity or that utilize the designated critical habitat that might be affected by the proposed activity. The district engineer will determine whether the proposed activity “may affect” or will have “no effect” to listed species and designated critical habitat and will notify the non-Federal applicant of the Corps’ determination within 45 days of receipt of a complete pre-construction notification. For activities where the non-Federal applicant has identified listed species or critical habitat that might be affected or is in the vicinity of the activity, and has so notified the Corps, the applicant shall not begin work until the Corps has provided notification that the proposed activity will have “no effect” on listed species or critical habitat, or until ESA section 7 consultation has been completed. If the non-Federal applicant has not heard back from the Corps within 45 days, the applicant must still wait for notification from the Corps.

(d) As a result of formal or informal consultation with the FWS or NMFS the district engineer may add species specific permit conditions to the NWP.

(e) Authorization of an activity by an NWP does not authorize the “take” of a threatened or endangered species as defined under the ESA. In the absence of separate authorization (e.g., an ESA Section 10 Permit, a Biological Opinion with “incidental take” provisions, etc.) from the FWS or the NMFS, the Endangered Species Act prohibits any person subject to the jurisdiction of the United States to take a listed species, where “take” means to harass, harm, pursue, hunt, shoot, wound, kill, trap, capture, or collect, or to attempt to engage in any such conduct. The word “harm” in the definition of “take” means an act which actually kills or injures wildlife. Such an act may include significant habitat modification or degradation where it actually kills or injures wildlife by significantly impairing essential behavioral patterns, including breeding, feeding or sheltering.

(f) If the non-federal permittee has a valid ESA section 10(a)(1)(B) incidental take permit with an approved Habitat Conservation Plan for a project or a group of projects that includes the proposed NWP activity, the non-federal applicant should provide a copy of that ESA section 10(a)(1)(B) permit with the PCN required by paragraph (c) of this general condition. The district engineer will coordinate with the agency that issued the ESA section 10(a)(1)(B) permit to determine whether the proposed NWP activity and the associated incidental take were considered in the internal ESA section 7 consultation conducted for the ESA section 10(a)(1)(B) permit. If that coordination results in concurrence from the agency that the proposed NWP activity and the associated incidental take were considered in the internal ESA section 7 consultation for the ESA section 10(a)(1)(B) permit, the district engineer does not need to conduct a separate ESA section 7 consultation for the proposed NWP activity. The district engineer will notify the non-federal applicant within 45 days of receipt of a complete pre-construction notification whether the ESA section 10(a)(1)(B) permit covers the proposed NWP activity or whether additional ESA section 7 consultation is required.

(g) Information on the location of threatened and endangered species and their critical habitat can be obtained directly from the offices of the FWS and NMFS or their worldwide Web pages at <http://www.fws.gov/> or <http://www.fws.gov/ipac> and <http://www.nmfs.noaa.gov/pr/species/esa/> respectively.

19. **Migratory Birds and Bald and Golden Eagles.** The permittee is responsible for ensuring that an action authorized by NWP complies with the Migratory Bird Treaty Act and the Bald and Golden Eagle Protection Act. The permittee is responsible for contacting the appropriate local office of the U.S. Fish and Wildlife Service to determine what measures, if any, are necessary or appropriate to reduce adverse effects to migratory birds or eagles, including whether "incidental take" permits are necessary and available under the Migratory Bird Treaty Act or Bald and Golden Eagle Protection Act for a particular activity.

20. **Historic Properties.**

(a) No activity is authorized under any NWP which may have the potential to cause effects to properties listed, or eligible for listing, in the National Register of Historic Places until the requirements of Section 106 of the National Historic Preservation Act (NHPA) have been satisfied.

(b) Federal permittees should follow their own procedures for complying with the requirements of section 106 of the National Historic Preservation Act (see 33 CFR 330.4(g)(1)). If pre-construction notification is required for the proposed NWP activity, the Federal permittee must provide the district engineer with the appropriate documentation to demonstrate compliance with those requirements. The district engineer will verify that the appropriate documentation has been submitted. If the appropriate documentation is not submitted, then additional consultation under section 106 may be necessary. The respective federal agency is responsible for fulfilling its obligation to comply with section 106.

(c) Non-federal permittees must submit a pre-construction notification to the district engineer if the NWP activity might have the potential to cause effects to any historic properties listed on, determined to be eligible for listing on, or potentially eligible for listing on the National Register of Historic Places, including previously unidentified properties. For such activities, the pre-construction notification must state which historic properties might have the potential to be affected by the proposed NWP activity or include a vicinity map indicating the location of the historic properties or the potential for the presence of historic properties. Assistance regarding information on the location of, or potential for, the presence of historic properties can be sought from the State Historic Preservation Officer, Tribal Historic Preservation Officer, or designated tribal representative, as appropriate, and the National Register of Historic Places (see 33 CFR 330.4(g)). When reviewing pre-construction notifications, district engineers will comply with the current procedures for addressing the requirements of section 106 of the National Historic Preservation Act. The district engineer shall make a reasonable and good faith effort to carry out appropriate identification efforts commensurate with potential impacts, which may include background research, consultation, oral history interviews, sample field investigation, and/or field survey. Based on the information submitted in the PCN and these identification efforts, the district engineer shall determine whether the proposed NWP activity has the potential to cause effects on the historic properties. Section 106 consultation is not required when the district engineer determines that the activity does not have the potential to cause effects on historic properties (see 36 CFR 800.3(a)). Section 106 consultation is required when the district engineer determines that the activity has the potential to cause effects on historic properties. The district engineer will conduct consultation with consulting parties identified under 36 CFR

P-10

800.2(c) when he or she makes any of the following effect determinations for the purposes of section 106 of the NHPA: no historic properties affected, no adverse effect, or adverse effect.

(d) Where the non-Federal applicant has identified historic properties on which the proposed NWP activity might have the potential to cause effects and has so notified the Corps, the non-Federal applicant shall not begin the activity until notified by the district engineer either that the activity has no potential to cause effects to historic properties or that NHPA section 106 consultation has been completed. For non-federal permittees, the district engineer will notify the prospective permittee within 45 days of receipt of a complete pre-construction notification whether NHPA section 106 consultation is required. If NHPA section 106 consultation is required, the district engineer will notify the non-Federal applicant that he or she cannot begin the activity until section 106 consultation is completed. If the non-Federal applicant has not heard back from the Corps within 45 days, the applicant must still wait for notification from the Corps.

(e) Prospective permittees should be aware that section 110k of the NHPA (54 U.S.C. 306113) prevents the Corps from granting a permit or other assistance to an applicant who, with intent to avoid the requirements of section 106 of the NHPA, has intentionally significantly adversely affected a historic property to which the permit would relate, or having legal power to prevent it, allowed such significant adverse effect to occur, unless the Corps, after consultation with the Advisory Council on Historic Preservation (ACHP), determines that circumstances justify granting such assistance despite the adverse effect created or permitted by the applicant. If circumstances justify granting the assistance, the Corps is required to notify the ACHP and provide documentation specifying the circumstances, the degree of damage to the integrity of any historic properties affected, and proposed mitigation. This documentation must include any views obtained from the applicant, SHPO/THPO, appropriate Indian tribes if the undertaking occurs on or affects historic properties on tribal lands or affects properties of interest to those tribes, and other parties known to have a legitimate interest in the impacts to the permitted activity on historic properties.

21. **Discovery of Previously Unknown Remains and Artifacts.** Permittees that discover any previously unknown historic, cultural or archeological remains and artifacts while accomplishing the activity authorized by NWP, they must immediately notify the district engineer of what they have found, and to the maximum extent practicable, avoid construction activities that may affect the remains and artifacts until the required coordination has been completed. The district engineer will initiate the Federal, Tribal, and state coordination required to determine if the items or remains warrant a recovery effort or if the site is eligible for listing in the National Register of Historic Places.

22. **Designated Critical Resource Waters.** Critical resource waters include, NOAA-managed marine sanctuaries and marine monuments, and National Estuarine Research Reserves. The district engineer may designate, after notice and opportunity for public comment, additional waters officially designated by a state as having particular environmental or ecological significance, such as outstanding national resource waters or state natural heritage sites. The district engineer may also designate additional critical resource waters after notice and opportunity for public comment.

(a) Discharges of dredged or fill material into waters of the United States are not authorized by NWPs 7, 12, 14, 16, 17, 21, 29, 31, 35, 39, 40, 42, 43, 44, 49, 50, 51, 52, 57 and 5258 for any activity within, or directly affecting, critical resource waters, including wetlands adjacent to such waters.

P-11

(b) For NWP 3, 8, 10, 13, 15, 18, 19, 22, 23, 25, 27, 28, 30, 33, 34, 36, 37, 38, and 54, notification is required in accordance with general condition 32, for any activity proposed by permittees in the designated critical resource waters including wetlands adjacent to those waters. The district engineer may authorize activities under these NWPs only after she or he determines that the impacts to the critical resource waters will be no more than minimal.

23. **Mitigation.** The district engineer will consider the following factors when determining appropriate and practicable mitigation necessary to ensure that the individual and cumulative adverse environmental effects are no more than minimal:

(a) The activity must be designed and constructed to avoid and minimize adverse effects, both temporary and permanent, to waters of the United States to the maximum extent practicable at the project site (*i.e.*, on site).

(b) Mitigation in all its forms (avoiding, minimizing, rectifying, reducing, or compensating for resource losses) will be required to the extent necessary to ensure that the individual and cumulative adverse environmental effects are no more than minimal.

(c) Compensatory mitigation at a minimum one-for-one ratio will be required for all wetland losses that exceed 1/10-acre and require pre-construction notification, unless the district engineer determines in writing that either some other form of mitigation would be more environmentally appropriate or the adverse environmental effects of the proposed activity are no more than minimal, and provides an activity-specific waiver of this requirement. For wetland losses of 1/10-acre or less that require pre-construction notification, the district engineer may determine on a case-by-case basis that compensatory mitigation is required to ensure that the activity results in only minimal adverse environmental effects.

(d) Compensatory mitigation at a minimum one-for-one ratio will be required for all losses of stream bed that exceed 1/103/100-acre and require pre-construction notification, unless the district engineer determines in writing that either some other form of mitigation would be more environmentally appropriate or the adverse environmental effects of the proposed activity are no more than minimal, and provides an activity-specific waiver of this requirement. This compensatory mitigation requirement may be satisfied through the restoration or enhancement of riparian areas next to streams in accordance with paragraph (e) of this general condition. For losses of stream bed of 1/103/100-acre or less that require pre-construction notification, the district engineer may determine on a case-by-case basis that compensatory mitigation is required to ensure that the activity results in only minimal adverse environmental effects. Compensatory mitigation for losses of streams should be provided, if practicable, through stream rehabilitation, enhancement, or preservation since streams are difficult-to-replace resources (see 33 CFR 332.3(e)(3)).

(e) Compensatory mitigation plans for NWP activities in or near streams or other open waters will normally include a requirement for the restoration or enhancement, maintenance, and legal protection (e.g., conservation easements) of riparian areas next to open waters. In some cases, the restoration or maintenance/protection of riparian areas may be the only compensatory mitigation required. If restoring riparian areas involves planting vegetation, only native species should be planted. The width of the required riparian area will address documented water quality or aquatic habitat loss concerns. Normally, the riparian area will be 25 to 50 feet wide on each side of the stream, but the district engineer may require slightly wider riparian areas to address documented water quality or habitat loss concerns. If it is not possible to restore or maintain/protect a riparian area on both sides of a stream, or if the

P-12

waterbody is a lake or coastal waters, then restoring or maintaining/protecting a riparian area along a single bank or shoreline may be sufficient. Where both wetlands and open waters exist on the project site, the district engineer will determine the appropriate compensatory mitigation (e.g., riparian areas and/or wetlands compensation) based on what is best for the aquatic environment on a watershed basis. In cases where riparian areas are determined to be the most appropriate form of minimization or compensatory mitigation, the district engineer may waive or reduce the requirement to provide wetland compensatory mitigation for wetland losses.

(f) Compensatory mitigation projects provided to offset losses of aquatic resources must comply with the applicable provisions of 33 CFR part 332.

(1) The prospective permittee is responsible for proposing an appropriate compensatory mitigation option if compensatory mitigation is necessary to ensure that the activity results in no more than minimal adverse environmental effects. For the NWP, the preferred mechanism for providing compensatory mitigation is mitigation bank credits or in-lieu fee program credits (see 33 CFR 332.3(b)(2) and (3)). However, if an appropriate number and type of mitigation bank or in-lieu credits are not available at the time the PCN is submitted to the district engineer, the district engineer may approve the use of permittee-responsible mitigation.

(2) The amount of compensatory mitigation required by the district engineer must be sufficient to ensure that the authorized activity results in no more than minimal individual and cumulative adverse environmental effects (see 33 CFR 330.1(e)(3)). (See also 33 CFR 332.3(f)).

(3) Since the likelihood of success is greater and the impacts to potentially valuable uplands are reduced, aquatic resource restoration should be the first compensatory mitigation option considered for permittee-responsible mitigation.

(4) If permittee-responsible mitigation is the proposed option, the prospective permittee is responsible for submitting a mitigation plan. A conceptual or detailed mitigation plan may be used by the district engineer to make the decision on the NWP verification request, but a final mitigation plan that addresses the applicable requirements of 33 CFR 332.4(c)(2) through (14) must be approved by the district engineer before the permittee begins work in waters of the United States, unless the district engineer determines that prior approval of the final mitigation plan is not practicable or not necessary to ensure timely completion of the required compensatory mitigation (see 33 CFR 332.3(k)(3)). If permittee-responsible mitigation is the proposed option, and the proposed compensatory mitigation site is located on land in which another federal agency holds an easement, the district engineer will coordinate with that federal agency to determine if proposed compensatory mitigation project is compatible with the terms of the easement.

(5) If mitigation bank or in-lieu fee program credits are the proposed option, the mitigation plan needs to address only the baseline conditions at the impact site and the number of credits to be provided (see 33 CFR 332.4(c)(1)(ii)).

(6) Compensatory mitigation requirements (e.g., resource type and amount to be provided as compensatory mitigation, site protection, ecological performance standards, monitoring requirements) may be addressed through conditions added to the NWP authorization, instead of components of a compensatory mitigation plan (see 33 CFR 332.4(c)(1)(ii)).

(g) Compensatory mitigation will not be used to increase the acreage losses allowed by the acreage limits of the NWP. For example, if an NWP has an acreage limit of 1/2-acre, it cannot be used to authorize any NWP activity resulting in the loss of greater than 1/2-acre of waters of the United States, even if compensatory mitigation is provided that replaces or restores some of the lost waters. However, compensatory mitigation can and should be used, as necessary, to ensure that an NWP activity already meeting the established acreage limits also satisfies the no more than minimal impact requirement for the NWP.

(h) Permittees may propose the use of mitigation banks, in-lieu fee programs, or permittee-responsible mitigation. When developing a compensatory mitigation proposal, the permittee must consider appropriate and practicable options consistent with the framework at 33 CFR 332.3(b). For activities resulting in the loss of marine or estuarine resources, permittee-responsible mitigation may be environmentally preferable if there are no mitigation banks or in-lieu fee programs in the area that have marine or estuarine credits available for sale or transfer to the permittee. For permittee-responsible mitigation, the special conditions of the NWP verification must clearly indicate the party or parties responsible for the implementation and performance of the compensatory mitigation project, and, if required, its long-term management.

(i) Where certain functions and services of waters of the United States are permanently adversely affected by a regulated activity, such as discharges of dredged or fill material into waters of the United States that will convert a forested or scrub-shrub wetland to an herbaceous wetland in a permanently maintained utility line right-of-way, mitigation may be required to reduce the adverse environmental effects of the activity to the no more than minimal level.

24. **Safety of Impoundment Structures.** To ensure that all impoundment structures are safely designed, the district engineer may require non-Federal applicants to demonstrate that the structures comply with established state or federal, dam safety criteria or have been designed by qualified persons. The district engineer may also require documentation that the design has been independently reviewed by similarly qualified persons, and appropriate modifications made to ensure safety.

25. **Water Quality.**

(a) Where the certifying authority (state, authorized tribe, or EPA, as appropriate) has not previously certified compliance of an NWP with CWA section 401, a CWA section 401 water quality certification for the proposed discharge must be obtained or waived (see 33 CFF 330.4(c)). If the permittee cannot comply with all of the conditions of a water quality certification previously issued by certifying authority for the issuance of the NWP, then the permittee must obtain a water quality certification or waiver for the proposed discharge in order for the activity to be authorized by an NWP.

(b) If the NWP activity requires pre-construction notification and the certifying authority has not previously certified compliance of an NWP with CWA section 401, the proposed discharge is not authorized by an NWP until water quality certification is obtained or waived. If the certifying authority issues a water quality certification for the proposed discharge, the permittee must submit a copy of the certification to the district engineer. The discharge is not authorized by an NWP until the district engineer has notified the permittee that the water quality certification requirement has been satisfied by the issuance of a water quality certification or a waiver.

(c) The district engineer or certifying authority may require additional water quality management measures to ensure that the authorized activity does not result in more than minimal degradation of water quality.

26. **Coastal Zone Management.** In coastal states where an NWP has not previously received a state coastal zone management consistency concurrence, an individual state coastal zone management consistency concurrence must be obtained, or a presumption of concurrence must occur (see 33 CFR 330.4(d)). If the permittee cannot comply with all of the conditions of a coastal zone management consistency concurrence previously issued by the state, then the permittee must obtain an individual coastal zone management consistency concurrence or presumption of concurrence in order for the activity to be authorized by an NWP. The district engineer or a state may require additional measures to ensure that the authorized activity is consistent with state coastal zone management requirements.

27. **Regional and Case-By-Case Conditions.** The activity must comply with any regional conditions that may have been added by the Division Engineer (see 33 CFR 330.4(e)) and with any case specific conditions added by the Corps or by the state, Indian Tribe, or U.S. EPA in its CWA section 401 Water Quality Certification, or by the state in its Coastal Zone Management Act consistency determination.

28. **Use of Multiple Nationwide Permits.** The use of more than one NWP for a single and complete project is authorized, subject to the following restrictions:

(a) If only one of the NWPs used to authorize the single and complete project has a specified acreage limit, the acreage loss of waters of the United States cannot exceed the acreage limit of the NWP with the highest specified acreage limit. For example, if a road crossing over tidal waters is constructed under NWP 14, with associated bank stabilization authorized by NWP 13, the maximum acreage loss of waters of the United States for the total project cannot exceed 1/3-acre.

(b) If one or more of the NWPs used to authorize the single and complete project has specified acreage limits, the acreage loss of waters of the United States authorized by those NWPs cannot exceed their respective specified acreage limits. For example, if a commercial development is constructed under NWP 39, and the single and complete project includes the filling of an upland ditch authorized by NWP 46, the maximum acreage loss of waters of the United States for the commercial development under NWP 39 cannot exceed 1/2-acre, and the total acreage loss of waters of United States due to the NWP 39 and 46 activities cannot exceed 1 acre.

29. **Transfer of Nationwide Permit Verifications.** If the permittee sells the property associated with a nationwide permit verification, the permittee may transfer the nationwide permit verification to the new owner by submitting a letter to the appropriate Corps district office to validate the transfer. A copy of the nationwide permit verification must be attached to the letter, and the letter must contain the following statement and signature:

“When the structures or work authorized by this nationwide permit are still in existence at the time the property is transferred, the terms and conditions of this nationwide permit, including any special conditions, will continue to be binding on the new owner(s) of the property. To validate the transfer of this nationwide permit and the associated liabilities associated with compliance with its terms and conditions, have the transferee sign and date below.”

(Transferee)

(Date)

30. **Compliance Certification.** Each permittee who receives an NWP verification letter from the Corps must provide a signed certification documenting completion of the authorized activity and implementation of any required compensatory mitigation. The success of any required permittee-responsible mitigation, including the achievement of ecological performance standards, will be addressed separately by the district engineer. The Corps will provide the permittee the certification document with the NWP verification letter. The certification document will include:

(a) A statement that the authorized activity was done in accordance with the NWP authorization, including any general, regional, or activity-specific conditions;

(b) A statement that the implementation of any required compensatory mitigation was completed in accordance with the permit conditions. If credits from a mitigation bank or in-lieu fee program are used to satisfy the compensatory mitigation requirements, the certification must include the documentation required by 33 CFR 332.3(l)(3) to confirm that the permittee secured the appropriate number and resource type of credits; and

(c) The signature of the permittee certifying the completion of the activity and mitigation. The completed certification document must be submitted to the district engineer within 30 days of completion of the authorized activity or the implementation of any required compensatory mitigation, whichever occurs later.

31. **Activities Affecting Structures or Works Built by the United States.** If an NWP activity also requires permission from the Corps pursuant to 33 U.S.C. 408 because it will alter or temporarily or permanently occupy or use a U.S. Army Corps of Engineers (USACE) federally authorized Civil Works project (a "USACE project"), the prospective permittee must submit a pre-construction notification. See paragraph (b)(10) of general condition 32. An activity that requires section 408 permission and/or review is not authorized by an NWP until the appropriate Corps office issues the section 408 permission or completes its review to alter, occupy, or use the USACE project, and the district engineer issues a written NWP verification.

32. **Pre-Construction Notification.**

(a) *Timing.* Where required by the terms of the NWP, the permittee must notify the district engineer by submitting a pre-construction notification (PCN) as early as possible. The district engineer must determine if the PCN is complete within 30 calendar days of the date of receipt and, if the PCN is determined to be incomplete, notify the prospective permittee within that 30 day period to request the additional information necessary to make the PCN complete. The request must specify the information needed to make the PCN complete. As a general rule, district engineers will request additional information necessary to make the PCN complete only once. However, if the prospective permittee does not provide all of the requested information, then the district engineer will notify the prospective permittee that the PCN is still incomplete and the PCN review process will not commence until all of the requested information has been received by the district engineer. The prospective permittee shall not begin the activity until either:

(1) He or she is notified in writing by the district engineer that the activity may proceed under the NWP with any special conditions imposed by the district or division engineer; or

P-16

(2) 45 calendar days have passed from the district engineer's receipt of the complete PCN and the prospective permittee has not received written notice from the district or division engineer. However, if the permittee was required to notify the Corps pursuant to general condition 18 that listed species or critical habitat might be affected or are in the vicinity of the activity, or to notify the Corps pursuant to general condition 20 that the activity might have the potential to cause effects to historic properties, the permittee cannot begin the activity until receiving written notification from the Corps that there is "no effect" on listed species or "no potential to cause effects" on historic properties, or that any consultation required under Section 7 of the Endangered Species Act (see 33 CFR 330.4(f)) and/or section 106 of the National Historic Preservation Act (see 33 CFR 330.4(g)) has been completed. If the proposed activity requires a written waiver to exceed specified limits of an NWP, the permittee may not begin the activity until the district engineer issues the waiver. If the district or division engineer notifies the permittee in writing that an individual permit is required within 45 calendar days of receipt of a complete PCN, the permittee cannot begin the activity until an individual permit has been obtained. Subsequently, the permittee's right to proceed under the NWP may be modified, suspended, or revoked only in accordance with the pr set forth in 33 CFR 330.5(d)(2).

(b) *Contents of Pre-Construction Notification:* The PCN must be in writing and include the following information:

- (1) Name, address and telephone numbers of the prospective permittee;
- (2) Location of the proposed activity;
- (3) Identify the specific NWP or NWP(s) the prospective permittee wants to use to authorize the proposed activity;
- (4)
 - (i) A description of the proposed activity; the activity's purpose; direct and indirect adverse environmental effects the activity would cause, including the anticipated amount of loss of wetlands, other special aquatic sites, and other waters expected to result from the NWP activity, in acres, linear feet, or other appropriate unit of measure; a description of any proposed mitigation measures intended to reduce the adverse environmental effects caused by the proposed activity; and any other NWP(s), regional general permit(s), or individual permit(s) used or intended to be used to authorize any part of the proposed project or any related activity, including other separate and distant crossings for linear projects that require Department of the Army authorization but do not require pre-construction notification. The description of the proposed activity and any proposed mitigation measures should be sufficiently detailed to allow the district engineer to determine that the adverse environmental effects of the activity will be no more than minimal and to determine the need for compensatory mitigation or other mitigation measures.
 - (ii) For linear projects where one or more single and complete crossings require pre-construction notification, the PCN must include the quantity of anticipated losses of wetlands, other special aquatic sites, and other waters for each single and complete crossing of those wetlands, other special aquatic sites, and other waters (including those single and complete crossings authorized by an NWP but do not require PCNs). This information will be used by the district engineer to evaluate the cumulative adverse

P-17

environmental effects of the proposed linear project and does not change those non-PCN NWP activities into NWP PCNs.

(iii) Sketches should be provided when necessary to show that the activity complies with the terms of the NWP. (Sketches usually clarify the activity and when provided results in a quicker decision. Sketches should contain sufficient detail to provide an illustrative description of the proposed activity (e.g., a conceptual plan), but do not need to be detailed engineering plans).

(5) The PCN must include a delineation of wetlands, other special aquatic sites, and other waters, such as lakes and ponds, and perennial and intermittent streams, on the project site. Wetland delineations must be prepared in accordance with the current method required by the Corps. The permittee may ask the Corps to delineate the special aquatic sites and other waters on the project site, but there may be a delay if the Corps does the delineation, especially if the project site is large or contains many wetlands, other special aquatic sites, and other waters. Furthermore, the 45-day period will not start until the delineation has been submitted to or completed by the Corps, as appropriate.

(6) If the proposed activity will result in the loss of greater than 1/10-acre of wetlands or 3/100-acre of stream bed and a PCN is required, the prospective permittee must submit a statement describing how the mitigation requirement will be satisfied, or explaining why the adverse environmental effects are no more than minimal and why compensatory mitigation should not be required. As an alternative, the prospective permittee may submit a conceptual or detailed mitigation plan.

(7) For non-federal permittees, if any listed species (or species proposed for listing) or designated critical habitat (or critical habitat proposed for such designation) might be affected or is in the vicinity of the activity, or if the activity is located in designated critical habitat (or critical habitat proposed for such designation), the PCN must include the name(s) of those endangered or threatened species (or species proposed for listing) that might be affected by the proposed activity or utilize the designated critical habitat (or critical habitat proposed for such designation) that might be affected by the proposed activity. For NWP activities that require pre-construction notification, Federal permittees must provide documentation demonstrating compliance with the Endangered Species Act.

(8) For non-federal permittees, if the NWP activity might have the potential to cause effects to a historic property listed on, determined to be eligible for listing on, or potentially eligible for listing on, the National Register of Historic Places, the PCN must state which historic property might have the potential to be affected by the proposed activity or include a vicinity map indicating the location of the historic property. For NWP activities that require pre-construction notification, Federal permittees must provide documentation demonstrating compliance with section 106 of the National Historic Preservation Act.

(9) For an activity that will occur in a component of the National Wild and Scenic River System, or in a river officially designated by Congress as a "study river" for possible inclusion in the system while the river is in an official study status, the PCN must identify the Wild and Scenic River or the "study river" (see general condition 16); and

(10) For an NWP activity that requires permission from, or review by, the Corps pursuant to 33 U.S.C. 408 because it will alter or temporarily or permanently occupy or use a U.S. Army Corps of Engineers federally authorized civil works project, the pre-construction notification must include a statement confirming that the project proponent has submitted a

P-18

written request for section 408 permission from, or review by, the Corps office having jurisdiction over that USACE project.

(c) *Form of Pre-Construction Notification:* The nationwide permit pre-construction notification form (Form ENG 6082) should be used for NWP PCNs. A letter containing the required information may also be used. Applicants may provide electronic files of PCNs and supporting materials if the district engineer has established tools and procedures for electronic submittals.

(d) *Agency Coordination:*

(1) The district engineer will consider any comments from Federal and state agencies concerning the proposed activity's compliance with the terms and conditions of the NWPs and the need for mitigation to reduce the activity's adverse environmental effects so that they are no more than minimal.

(2) Agency coordination is required for:

(i) All NWP activities that require pre-construction notification and result in the loss of greater than 1/2-acre of waters of the United States;

(ii) NWP 13 activities in excess of 500 linear feet, fills greater than one cubic yard per running foot, or involve discharges of dredged or fill material into special aquatic sites; and

(iii) NWP 54 activities in excess of 500 linear feet, or that extend into the waterbody more than 30 feet from the mean low water line in tidal waters or the ordinary high water mark in the Great Lakes.

(3) When agency coordination is required, the district engineer will immediately provide (e.g., via email, facsimile transmission, overnight mail, or other expeditious manner) a copy of the complete PCN to the appropriate Federal or state offices (FWS, state natural resource or water quality agency, EPA, and, if appropriate, the NMFS). With the exception of NWP 37, these agencies will have 10 calendar days from the date the material is transmitted to notify the district engineer via telephone, facsimile transmission, or email that they intend to provide substantive, site-specific comments. The comments must explain why the agency believes the adverse environmental effects will be more than minimal. If so, contacted by an agency, the district engineer will wait an additional 15 calendar days before making a decision on the pre-construction notification. The district engineer will fully consider agency comments received within the specified time frame concerning the proposed activity's compliance with the terms and conditions of the NWPs, including the need for mitigation to ensure that the net adverse environmental effects of the proposed activity are no more than minimal. The district engineer will provide no response to the resource agency, except as provided below. The district engineer will indicate in the administrative record associated with each pre-construction notification that the resource agencies' concerns were considered. For NWP 37, the emergency watershed protection and rehabilitation activity may proceed immediately in cases where there is an unacceptable hazard to life or a significant loss of property or economic hardship will occur. The district engineer will consider any comments received to decide whether the NWP 37 authorization should be modified, suspended, or revoked in accordance with the procedures at 33 CFR 330.5.

(4) In cases of where the prospective permittee is not a Federal agency, the district engineer will provide a response to NMFS within 30 calendar days of receipt of any Essential Fish Habitat conservation recommendations, as required by section 305(b)(4)(B) of the Magnuson-Stevens Fishery Conservation and Management Act.

(5) Applicants are encouraged to provide the Corps with either electronic files or multiple copies of pre-construction notifications to expedite agency coordination.

DISTRICT ENGINEER'S DECISION

1. In reviewing the PCN for the proposed activity, the district engineer will determine whether the activity authorized by the NWP will result in more than minimal individual or cumulative adverse environmental effects or may be contrary to the public interest. If a project proponent requests authorization by a specific NWP, the district engineer should issue the NWP verification for that activity if it meets the terms and conditions of that NWP, unless he or she determines, after considering mitigation, that the proposed activity will result in more than minimal individual and cumulative adverse effects on the aquatic environment and other aspects of the public interest and exercises discretionary authority to require an individual permit for the proposed activity. For a linear project, this determination will include an evaluation of the single and complete crossings of waters of the United States that require PCNs to determine whether they individually satisfy the terms and conditions of the NWP(s), as well as the cumulative effects caused by all of the crossings of waters of the United States authorized by an NWP. If an applicant requests a waiver of an applicable limit, as provided for in NWPs 13, 36, or 54, the district engineer will only grant the waiver upon a written determination that the NWP activity will result in only minimal individual and cumulative adverse environmental effects.

2. When making minimal adverse environmental effects determinations the district engineer will consider the direct and indirect effects caused by the NWP activity. He or she will also consider the cumulative adverse environmental effects caused by activities authorized by an NWP and whether those cumulative adverse environmental effects are no more than minimal. The district engineer will also consider site specific factors, such as the environmental setting in the vicinity of the NWP activity, the type of resource that will be affected by the NWP activity, the functions provided by the aquatic resources that will be affected by the NWP activity, the degree or magnitude to which the aquatic resources perform those functions, the extent that aquatic resource functions will be lost as a result of the NWP activity (e.g., partial or complete loss), the duration of the adverse effects (temporary or permanent), the importance of the aquatic resource functions to the region (e.g., watershed or ecoregion), and mitigation required by the district engineer. If an appropriate functional or condition assessment method is available and practicable to use, that assessment method may be used by the district engineer to assist in the minimal adverse environmental effects determination. The district engineer may add case-specific special conditions to the NWP authorization to address site-specific environmental concerns.

3. If the proposed activity requires a PCN and will result in a loss of greater than 1/10-acre of wetlands or 3/100-acre of stream bed, the prospective permittee should submit a mitigation proposal with the PCN. Applicants may also propose compensatory mitigation for NWP activities with smaller impacts, or for impacts to other types of waters. The district engineer will consider any proposed compensatory mitigation or other mitigation measures the applicant has included in the proposal in determining whether the net adverse environmental effects of the proposed activity are no more than minimal. The compensatory mitigation proposal may be either conceptual or detailed. If the district engineer determines that the activity complies with

the terms and conditions of the NWP and that the adverse environmental effects are no more than minimal, after considering mitigation, the district engineer will notify the permittee and include any activity-specific conditions in the NWP verification the district engineer deems necessary. Conditions for compensatory mitigation requirements must comply with the appropriate provisions at 33 CFR 332.3(k). The district engineer must approve the final mitigation plan before the permittee commences work in waters of the United States, unless the district engineer determines that prior approval of the final mitigation plan is not practicable or not necessary to ensure timely completion of the required compensatory mitigation. If the prospective permittee elects to submit a compensatory mitigation plan with the PCN, the district engineer will expeditiously review the proposed compensatory mitigation plan. The district engineer must review the proposed compensatory mitigation plan within 45 calendar days of receiving a complete PCN and determine whether the proposed mitigation would ensure that the NWP activity results in no more than minimal adverse environmental effects. If the net adverse environmental effects of the NWP activity (after consideration of the mitigation proposal) are determined by the district engineer to be no more than minimal, the district engineer will provide a timely written response to the applicant. The response will state that the NWP activity can proceed under the terms and conditions of the NWP, including any activity-specific conditions added to the NWP authorization by the district engineer.

4. If the district engineer determines that the adverse environmental effects of the proposed activity are more than minimal, then the district engineer will notify the applicant either:

(a) That the activity does not qualify for authorization under the NWP and instruct the applicant on the procedures to seek authorization under an individual permit;

(b) that the activity is authorized under the NWP subject to the applicant's submission of a mitigation plan that would reduce the adverse environmental effects so that they are no more than minimal; or

(c) that the activity is authorized under the NWP with specific modifications or conditions. Where the district engineer determines that mitigation is required to ensure no more than minimal adverse environmental effects, the activity will be authorized within the 45-day PCN period (unless additional time is required to comply with general conditions 18, 20, and/or 31), with activity-specific conditions that state the mitigation requirements. The authorization will include the necessary conceptual or detailed mitigation plan or a requirement that the applicant submit a mitigation plan that would reduce the adverse environmental effects so that they are no more than minimal. When compensatory mitigation is required, no work in waters of the United States may occur until the district engineer has approved a specific mitigation plan or has determined that prior approval of a final mitigation plan is not practicable or not necessary to ensure timely completion of the required compensatory mitigation.

FURTHER INFORMATION

1. District engineers have authority to determine if an activity complies with the terms and conditions of an NWP.
2. NWPs do not obviate the need to obtain other federal, state, or local permits, approvals, or authorizations required by law.
3. NWPs do not grant any property rights or exclusive privileges.
4. NWPs do not authorize any injury to the property or rights of others.
5. NWPs do not authorize interference with any existing or proposed Federal project (see general condition 31).

DEFINITIONS

Best management practices (BMPs): Policies, practices, procedures, or structures implemented to mitigate the adverse environmental effects on surface water quality resulting from development. BMPs are categorized as structural or non-structural.

Compensatory mitigation: The restoration (re-establishment or rehabilitation), establishment (creation), enhancement, and/or in certain circumstances preservation of aquatic resources for the purposes of offsetting unavoidable adverse impacts which remain after all appropriate and practicable avoidance and minimization has been achieved.

Currently serviceable: Useable as is or with some maintenance, but not so degraded as to essentially require reconstruction.

Direct effects: Effects that are caused by the activity and occur at the same time and place.

Discharge: The term “discharge” means any discharge of dredged or fill material into waters of the United States.

Ecological reference: A model used to plan and design an aquatic habitat and riparian area restoration, enhancement, or establishment activity under NWP 27. An ecological reference may be based on the structure, functions, and dynamics of an aquatic habitat type or a riparian area type that currently exists in the region where the proposed NWP 27 activity is located. Alternatively, an ecological reference may be based on a conceptual model for the aquatic habitat type or riparian area type to be restored, enhanced, or established as a result of the proposed NWP 27 activity. An ecological reference takes into account the range of variation of the aquatic habitat type or riparian area type in the region.

Enhancement: The manipulation of the physical, chemical, or biological characteristics of an aquatic resource to heighten, intensify, or improve a specific aquatic resource function(s). Enhancement results in the gain of selected aquatic resource function(s), but may also lead to a decline in other aquatic resource function(s). Enhancement does not result in a gain in aquatic resource area.

Establishment (creation): The manipulation of the physical, chemical, or biological characteristics present to develop an aquatic resource that did not previously exist at an upland site. Establishment results in a gain in aquatic resource area.

High Tide Line: The line of intersection of the land with the water’s surface at the maximum height reached by a rising tide. The high tide line may be determined, in the absence of actual data, by a line of oil or scum along shore objects, a more or less continuous deposit of fine shell or debris on the foreshore or berm, other physical markings or characteristics, vegetation lines, tidal gages, or other suitable means that delineate the general height reached by a rising tide. The line encompasses spring high tides and other high tides that occur with periodic frequency but does not include storm surges in which there is a departure from the normal or predicted reach of the tide due to the piling up of water against a coast by strong winds such as those accompanying a hurricane or other intense storm.

Historic Property: Any prehistoric or historic district, site (including archaeological site), building, structure, or other object included in, or eligible for inclusion in, the National

P-22

Nationwide Permit 3 - Activities, Regional Conditions, General Conditions, and Definitions

Register of Historic Places maintained by the Secretary of the Interior. This term includes artifacts, records, and remains that are related to and located within such properties. The term includes properties of traditional religious and cultural importance to an Indian tribe or Native Hawaiian organization and that meet the National Register criteria (36 CFR part 60).

Independent utility: A test to determine what constitutes a single and complete non-linear project in the Corps Regulatory Program. A project is considered to have independent utility if it would be constructed absent the construction of other projects in the project area. Portions of a multi-phase project that depend upon other phases of the project do not have independent utility. Phases of a project that would be constructed even if the other phases were not built can be considered as separate single and complete projects with independent utility.

Indirect effects: Effects that are caused by the activity and are later in time or farther removed in distance but are still reasonably foreseeable.

Loss of waters of the United States: Waters of the United States that are permanently adversely affected by filling, flooding, excavation, or drainage because of the regulated activity. The loss of stream bed includes the acres of stream bed that are permanently adversely affected by filling or excavation because of the regulated activity. Permanent adverse effects include permanent discharges of dredged or fill material that change an aquatic area to dry land, increase the bottom elevation of a waterbody, or change the use of a waterbody. The acreage of loss of waters of the United States is a threshold measurement of the impact to jurisdictional waters or wetlands for determining whether a project may qualify for an NWP; it is not a net threshold that is calculated after considering compensatory mitigation that may be used to offset losses of aquatic functions and services. Waters of the United States temporarily filled, flooded, excavated, or drained, but restored to pre-construction contours and elevations after construction, are not included in the measurement of loss of waters of the United States. Impacts resulting from activities that do not require Department of the Army authorization, such as activities eligible for exemptions under section 404(f) of the Clean Water Act, are not considered when calculating the loss of waters of the United States.

Navigable waters: Waters subject to section 10 of the Rivers and Harbors Act of 1899. These waters are defined at 33 CFR part 329.

Non-tidal wetland: A non-tidal wetland is a wetland that is not subject to the ebb and flow of tidal waters. Non-tidal wetlands contiguous to tidal waters are located landward of the high tide line (i.e., spring high tide line).

Open water: For purposes of the NWPs, an open water is any area that in a year with normal patterns of precipitation has water flowing or standing above ground to the extent that an ordinary high water mark can be determined. Aquatic vegetation within the area of flowing or standing water is either non-emergent, sparse, or absent. Vegetated shallows are considered to be open waters. Examples of "open waters" include rivers, streams, lakes, and ponds.

Ordinary High Water Mark: The term ordinary high water mark means that line on the shore established by the fluctuations of water and indicated by physical characteristics such as a clear, natural line impressed on the bank, shelving, changes in the character of soil, destruction of terrestrial vegetation, the presence of litter and debris, or other appropriate means that consider the characteristics of the surrounding areas.

Perennial stream: A perennial stream has surface water flowing continuously year-round during a typical year.

P-23

Nationwide Permit 3 - Activities, Regional Conditions, General Conditions, and Definitions

Practicable: Available and capable of being done after taking into consideration cost, existing technology, and logistics in light of overall project purposes.

Pre-construction notification: A request submitted by the project proponent to the Corps for confirmation that a particular activity is authorized by nationwide permit. The request may be a permit application, letter, or similar document that includes information about the proposed work and its anticipated environmental effects. Pre-construction notification may be required by the terms and conditions of a nationwide permit, or by regional conditions. A pre-construction notification may be voluntarily submitted in cases where pre-construction notification is not required and the project proponent wants confirmation that the activity is authorized by nationwide permit.

Preservation: The removal of a threat to, or preventing the decline of, aquatic resources by an action in or near those aquatic resources. This term includes activities commonly associated with the protection and maintenance of aquatic resources through the implementation of appropriate legal and physical mechanisms. Preservation does not result in a gain of aquatic resource area or functions.

Re-establishment: The manipulation of the physical, chemical, or biological characteristics of a site with the goal of returning natural/historic functions to a former aquatic resource. Re-establishment results in rebuilding a former aquatic resource and results in a gain in aquatic resource area and functions.

Rehabilitation: The manipulation of the physical, chemical, or biological characteristics of a site with the goal of repairing natural/historic functions to a degraded aquatic resource. Rehabilitation results in a gain in aquatic resource function but does not result in a gain in aquatic resource area.

Restoration: The manipulation of the physical, chemical, or biological characteristics of a site with the goal of returning natural/historic functions to a former or degraded aquatic resource. For the purpose of tracking net gains in aquatic resource area, restoration is divided into two categories: Re-establishment and rehabilitation.

Riffle and pool complex: Riffle and pool complexes are special aquatic sites under the 404(b)(1) Guidelines. Riffle and pool complexes sometimes characterize steep gradient sections of streams. Such stream sections are recognizable by their hydraulic characteristics. The rapid movement of water over a coarse substrate in riffles results in a rough flow, a turbulent surface, and high dissolved oxygen levels in the water. Pools are deeper areas associated with riffles. A slower stream velocity, a streaming flow, a smooth surface, and a finer substrate characterize pools.

Riparian areas: Riparian areas are lands next to streams, lakes, and estuarine-marine shorelines. Riparian areas are transitional between terrestrial and aquatic ecosystems, through which surface and subsurface hydrology connects riverine, lacustrine, estuarine, and marine waters with their adjacent wetlands, non-wetland waters, or uplands. Riparian areas provide a variety of ecological functions and services and help improve or maintain local water quality. (See general condition 23.)

Shellfish seeding: The placement of shellfish seed and/or suitable substrate to increase shellfish production. Shellfish seed consists of immature individual shellfish or individual shellfish attached to shells or shell fragments (i.e., spat on shell). Suitable substrate may

P-24

consist of shellfish shells, shell fragments, or other appropriate materials placed into waters for shellfish habitat.

Single and complete linear project: A linear project is a project constructed for the purpose of getting people, goods, or services from a point of origin to a terminal point, which often involves multiple crossings of one or more waterbodies at separate and distant locations. The term “single and complete project” is defined as that portion of the total linear project proposed or accomplished by one owner/developer or partnership or other association of owners/developers that includes all crossings of a single water of the United States (i.e., a single waterbody) at a specific location. For linear projects crossing a single or multiple waterbodies several times at separate and distant locations, each crossing is considered a single and complete project for purposes of NWP authorization. However, individual channels in a braided stream or river, or individual arms of a large, irregularly shaped wetland or lake, etc., are not separate waterbodies, and crossings of such features cannot be considered separately.

Single and complete non-linear project: For non-linear projects, the term “single and complete project” is defined at 33 CFR 330.2(i) as the total project proposed or accomplished by one owner/developer or partnership or other association of owners/developers. A single and complete non-linear project must have independent utility (see definition of “independent utility”). Single and complete non-linear projects may not be “piecemealed” to avoid the limits in an NWP authorization.

Stormwater management: Stormwater management is the mechanism for controlling stormwater runoff for the purposes of reducing downstream erosion, water quality degradation, and flooding and mitigating the adverse effects of changes in land use on the aquatic environment.

Stormwater management facilities: Stormwater management facilities are those facilities, including but not limited to, stormwater retention and detention ponds and best management practices, which retain water for a period of time to control runoff and/or improve the quality (i.e., by reducing the concentration of nutrients, sediments, hazardous substances and other pollutants) of stormwater runoff.

Stream bed: The substrate of the stream channel between the ordinary high water marks. The substrate may be bedrock or inorganic particles that range in size from clay to boulders. Wetlands contiguous to the stream bed, but outside of the ordinary high water marks, are not considered part of the stream bed.

Stream channelization: The manipulation of a stream’s course, condition, capacity, or location that causes more than minimal interruption of normal stream processes. A channelized jurisdictional stream remains a water of the United States.

Structure: An object that is arranged in a definite pattern of organization. Examples of structures include, without limitation, any pier, boat dock, boat ramp, wharf, dolphin, weir, boom, breakwater, bulkhead, revetment, riprap, jetty, artificial island, artificial reef, permanent mooring structure, power transmission line, permanently moored floating vessel, piling, aid to navigation, or any other manmade obstacle or obstruction.

Tidal wetland: A tidal wetland is a jurisdictional wetland that is inundated by tidal waters. Tidal waters rise and fall in a predictable and measurable rhythm or cycle due to the gravitational pulls of the moon and sun. Tidal waters end where the rise and fall of the water surface can no

P-25

Nationwide Permit 3 - Activities, Regional Conditions, General Conditions, and Definitions

longer be practically measured in a predictable rhythm due to masking by other waters, wind, or other effects. Tidal wetlands are located channelward of the high tide line.

Tribal lands: Any lands title to which is either: (1) Held in trust by the United States for the benefit of any Indian tribe or individual; or (2) held by any Indian tribe or individual subject to restrictions by the United States against alienation.

Tribal rights: Those rights legally accruing to a tribe or tribes by virtue of inherent sovereign authority, unextinguished aboriginal title, treaty, statute, judicial decisions, executive order or agreement, and that give rise to legally enforceable remedies.

Vegetated shallows: Vegetated shallows are special aquatic sites under the 404(b)(1) Guidelines. They are areas that are permanently inundated and under normal circumstances have rooted aquatic vegetation, such as seagrasses in marine and estuarine systems and a variety of vascular rooted plants in freshwater systems.

Waterbody: For purposes of the NWP's, a waterbody is a "water of the United States." If a wetland is adjacent to a waterbody determined to be a water of the United States, that waterbody and any adjacent wetlands are considered together as a single aquatic unit (see 33 CFR 328.4(c)(2)).

REGIONAL CONDITIONS:

The following Regional Conditions have been approved by the Wilmington District for the Nationwide Permits (NWP) published in the January 13, 2021, and December 27, 2021, *Federal Register* (86 FR 2744 and 86 FR 73522) announcing the reissuance of 52 existing (NWP) and five new NWP, as well as the reissuance of NWP general conditions and definitions with some modifications.

A. EXCLUDED WATER AND/OR AREAS

The Corps has identified waters that will be excluded from the use of all NWP's during certain timeframes. These waters are:

1. **Anadromous Fish Spawning Areas.** Work in waters of the U.S. designated by either the North Carolina Division of Marine Fisheries (NCDMF) or the North Carolina Wildlife Resources Commission (NCWRC) as anadromous fish spawning areas are prohibited from February 15th through June 30th, without prior written approval from the Corps and the appropriate wildlife agencies (NCDMF, NCWRC and/or the National Marine Fisheries Service (NMFS)). Work in waters of the U.S. designated by NCWRC as primary nursery areas in inland waters are prohibited from February 15th through September 30th, without prior written approval from the Corps and the appropriate wildlife agencies. Work in waters of the U.S. designated by NCDMF as primary nursery areas shall be coordinated with NCDMF prior to being authorized by this NWP. Coordination with NCDMF may result in a required construction moratorium during periods of significant biological productivity or critical life stages.
2. **Trout Waters Moratorium.** Work in waters of the U.S. in the designated trout watersheds of North Carolina are prohibited from October 15th through April 15th without prior written approval from the NCWRC, or from the Eastern Band of Cherokee Indians (EBCI) Fisheries and Wildlife Management (FWM) office if the project is located on EBCI trust land. (See Section C.3. below for information on the designated trout watersheds).
3. **Sturgeon Spawning Areas.** No in-water work shall be conducted in waters of the U.S. designated by the National Marine Fisheries Service as Atlantic sturgeon critical habitat from February 1st through June 30th. No in-water work shall be conducted in waters of the U.S. in the Roanoke River designated as Atlantic sturgeon critical habitat from February 1st through June 30th, and August 1st through October 31st, without prior written approval from NMFS.
4. **Submerged Aquatic Vegetation.** Impacts to Submerged Aquatic Vegetation (SAV) are not authorized by any NWP, except NWP 48, NWP 55 and NWP 56, unless Essential Fish Habitat (EFH) consultation has been completed pursuant to the Magnuson-Stevens Fisheries Conservation and Management Act (Magnuson-Stevens Act). Permittees shall submit a PCN (See NWP General Condition 32) to the District Engineer prior to commencing the activity if the project would affect SAV. The permittee may not begin work until notified by the Corps that the requirements of the Magnuson-Stevens Act have been satisfied and that the activity is verified.

B. REGIONAL CONDITIONS APPLICABLE TO ALL NWP's

1. **Critical Habitat in Western NC.** For proposed activities within waters of the U.S. that require a Pre-Construction Notification (PCN) and are located in the thirteen counties listed below, permittees must provide a copy of the PCN to the U.S. Fish and Wildlife Service (USFWS), 160 Zillicoa Street, Asheville, North Carolina 28801 and the Corps Asheville Regulatory Field Office. Please see General Condition 18 for specific PCN requirements

P-27

Nationwide Permit 3 - Activities, Regional Conditions, General Conditions, and Definitions

related to the Endangered Species Act and the below website for information on the location of designated critical habitat.

Counties with tributaries that drain to designated critical habitat that require notification to the Asheville U.S. Fish and Wildlife Service: Avery, Cherokee, Graham, Haywood, Henderson, Jackson, Macon, Mecklenburg, Mitchell, Swain, Transylvania, Union and Yancey.

Website and office addresses for Endangered Species Act Information:

The Wilmington District has developed the following website for permittees which provides guidelines on how to review linked websites and maps in order to fulfill NWP General Condition 18 (Endangered Species) requirements:

<http://www.saw.usace.army.mil/Missions/RegulatoryPermitProgram/AgencyCoordination/ESA.aspx>.

Permittees who do not have internet access may contact the appropriate U.S. Fish and Wildlife Service offices listed below or Corps at (910) 251-4850.

Below is a map of the USFWS Field Office Boundaries:

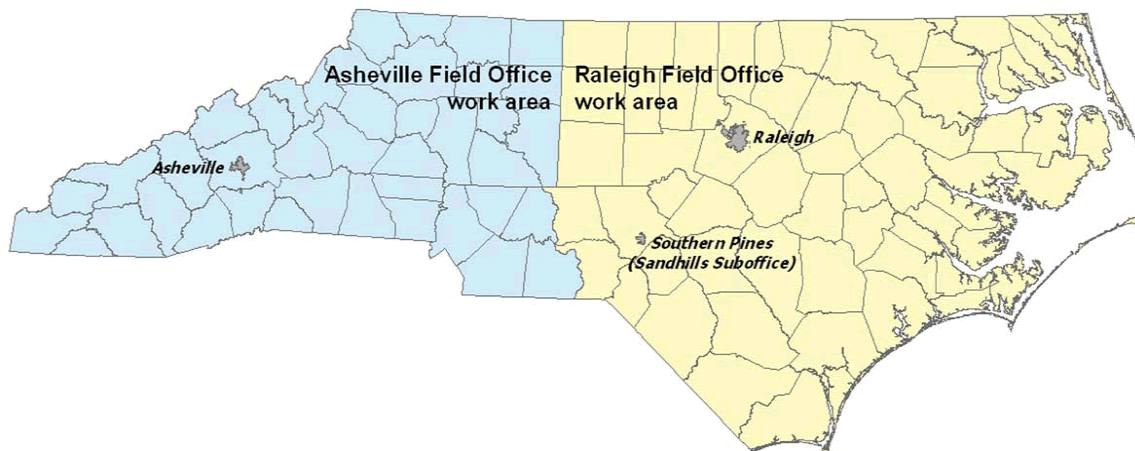

Asheville U.S. Fish and Wildlife Service Office counties: All counties west of and including Anson, Stanly, Davidson, Forsythe and Stokes Counties.

U.S. Fish and Wildlife Service
Asheville Field Office
160 Zillicoa Street
Asheville, NC 28801
Telephone: (828) 258-3939

Raleigh U.S. Fish and Wildlife Service Office counties: All counties east of and including Richmond, Montgomery, Randolph, Guilford, and Rockingham Counties.

U.S. Fish and Wildlife Service
Raleigh Field Office
Post Office Box 33726
Raleigh, NC 27636-3726
Telephone: (919) 856-4520

2. **Special Designation Waters.** Prior to the use of any NWP that involves a discharge of dredged or fill material in any of the following identified waters and/or adjacent wetlands in North Carolina, permittees shall submit a PCN to the District Engineer prior to commencing the activity (see General Condition 32). The North Carolina waters and wetlands that require additional PCN requirements are:

“Primary Nursery Areas” (PNA), including inland PNA, as designated by the North Carolina Marine Fisheries Commission and/or the North Carolina Wildlife Resources Commission. The definition of and designated PNA waters can be found in the North Carolina State Administrative Code at Title 15A, Subchapters 3R and 10C (15A NCAC 03R .0103; 15A NCAC 10C .0502; and 15A NCAC 10C .0503) and at the following web pages:

- <http://reports.oah.state.nc.us/ncac/title%2015a%20-%20environmental%20quality/chapter%2003%20-%20marine%20fisheries/subchapter%20r/15a%20ncac%2003r%20.0103.pdf>
- <http://reports.oah.state.nc.us/ncac/title%2015a%20-%20environmental%20quality/chapter%2010%20-%20wildlife%20resources%20and%20water%20safety/subchapter%20c/15a%20ncac%2010c%20.0502.pdf>
- <http://reports.oah.state.nc.us/ncac/title%2015a%20-%20environmental%20quality/chapter%2010%20-%20wildlife%20resources%20and%20water%20safety/subchapter%20c/15a%20ncac%2010c%20.0503.pdf>

3. **Trout Waters.** Prior to any discharge of dredge or fill material into streams, waterbodies or wetlands within the 294 designated trout watersheds of North Carolina, the permittee shall submit a PCN (see General Condition 32) to the District Engineer prior to commencing the activity. The permittee shall also provide a copy of the PCN to the appropriate NCWRC office, or to the EBCI FWM Office (if the project is located on EBCI trust land), to facilitate the determination of any potential impacts to designated Trout Waters.

NCWRC and NC Trout Watersheds:

NCWRC Contact**	Counties that are entirely within Trout Watersheds*	Counties that are partially within Trout Watersheds*
-----------------	---	--

P-29

Nationwide Permit 3 - Activities, Regional Conditions, General Conditions, and Definitions

Mountain Coordinator 645 Fish Hatchery Rd., Building B Marion, NC 28752 828-803- 6054 For NCDOT Projects: NCDOT Coordinator 12275 Swift Rd. Oakboro, NC 28129 704-984- 1070	Alleghany Ashe Avery Graham Haywood	Jackson Macon Swain Transylvania Watauga	Burke Buncombe Caldwell Cherokee Clay Henderson Madison	McDowell Mitchell Polk Rutherford Surry Wilkes Yancey
EBCI Contact**	Counties that are within Trout Watersheds*			
Office of Natural Resources P.O. Box 1747, Cherokee, NC 28719 (828) 359-6113	Qualla Boundary and non- contiguous tracts of trust land located in portions of Swain, Jackson, Haywood, Graham and Cherokee Counties.			

*NOTE: To determine PCN requirements, contact the Corps Asheville Regulatory Field Office at (828) 271-7980 or view maps showing trout watersheds in each County at the following webpage: <http://www.saw.usace.army.mil/Missions/Regulatory-Permit-Program/Agency-Coordination/Trout/>.

**If a project is located on EBCI trust land, submit the PCN in accordance with Regional Condition C.16. Contact the Corps Asheville Regulatory Field Office at (828) 271-7980 with questions.

4. **Western NC Waters and Corridors.** The permittee shall submit a PCN (see General Condition 32) to the District Engineer prior to commencing the activity in waters of the U.S. if the activity will occur within any of the following identified waters in western North Carolina, within 0.5 mile on either side of these waters, or within 0.75 mile of the Little Tennessee River, as measured from the top of the bank of the respective water (i.e., river, stream, or creek):

Brasstown Creek
Burningtown Creek

P-30

Nationwide Permit 3 - Activities, Regional Conditions, General Conditions, and Definitions

Cane River
Caney Fork
Cartoogechaye Creek
Chattooga River
Cheoah River
Cowee Creek
Cullasaja River
Deep Creek
Ellijay Creek
French Broad River
Garden Creek
Hiwassee River
Hominy Creek
Iotla Creek
Little Tennessee River (within the river or within 0.75 mile on either side of this river)
Nantahala River
Nolichucky River
North Fork French Broad River
North Toe River
Nottley River
Oconaluftee River (portion not located on trust/EBCI land)
Peachtree Creek
Shooting Creek
Snowbird Creek
South Toe River
Stecoah Creek
Swannanoa River
Sweetwater Creek
Tuckasegee River (also spelled Tuckaseegee or Tuckaseigee)
Valley River
Watauga Creek
Watauga River
Wayah Creek
West Fork French Broad River

To determine PCN requirements, contact the Corps Asheville Regulatory Field Office at (828) 271-7980 or view maps for all corridors at the following webpage:

<http://www.saw.usace.army.mil/Missions/Regulatory-Permit-Program/Agency-Coordination/Designated-Special-Waters.aspx>.

5. **Limitation of Loss of Stream Bed.** NWP's may not be used for activities that may result in the loss of more than 0.05 acres of stream bed, except for NWP 32.
6. **Pre-Construction Notification for Loss of Stream Bed Exceeding 0.02 acres.** The permittee shall submit a PCN to the District Engineer prior to commencing the activity (see General Condition 32) prior to the use of any NWP for any activity that results in the loss of more than 0.02 acres of stream bed. This applies to NWP's that do not have PCN requirements as well as those NWP's that require a PCN.
7. **Mitigation for Loss of Stream Bed.** For any NWP that results in a loss of more than 0.02 acres of stream bed, the permittee shall provide a mitigation proposal to compensate for more than minimal individual and cumulative adverse impacts to the aquatic environment, unless the

P-31

District Engineer determines in writing that either some other form of mitigation would be more environmentally appropriate or the adverse effects of the proposed activity are minimal. For stream bed losses of 0.02 acres or less that require a PCN, the District Engineer may determine, on a case-by-case basis, that compensatory mitigation is required to ensure that the activity results in minimal adverse effect on the aquatic environment.

8. **Riprap.** For all NWP's that allow for the use of riprap material for bank stabilization, the following conditions shall be applied:

a. Filter cloth must be placed underneath the riprap as an additional requirement of its use in North Carolina waters. The placement of filter fabric is not required if the riprap will be pushed or "keyed" into the bank of the waterbody. A waiver from the specifications in this Regional Condition must be requested in writing.

b. Riprap shall be placed only on the stream banks, or, if it is necessary to be placed in the stream bed, the finished top elevation of the riprap should not exceed that of the original stream bed.

9. **Culvert Placement.** For all NWP's that allow for culvert placement, the following conditions shall be applied:

a. For all NWP's that involve the construction/installation of culverts, measures shall be included in the construction/installation that will promote the safe passage of fish and other aquatic organisms

Placement of culverts and other structures in streams shall be below the elevation of the streambed by one foot for all culverts with a diameter greater than 48 inches, and 20% of the culvert diameter for culverts having a diameter less than or equal to 48 inches. If the culvert outlet is submerged within a pool or scour hole and designed to provide for aquatic passage, then culvert burial into the streambed is not required.

Culvert burial is not required for structures less than 72 inch diameter/width, where the slope of the culvert will be greater than 2.5%, provided that all alternative options for flattening the slope have been investigated and aquatic life movement/connectivity has been provided when possible (e.g., rock ladders, cross vanes, sills, baffles etc.). Culvert burial is not required when bedrock is present in culvert locations.

Installation of culverts in wetlands shall ensure continuity of water movement and be designed to adequately accommodate high water or flood conditions. When roadways, causeways, or other fill projects are constructed across FEMA-designated floodways or wetlands, openings such as culverts or bridges shall be provided to maintain the natural hydrology of the system as well as prevent constriction of the floodway that may result in destabilization of streams or wetlands.

P-32

Nationwide Permit 3 - Activities, Regional Conditions, General Conditions, and Definitions

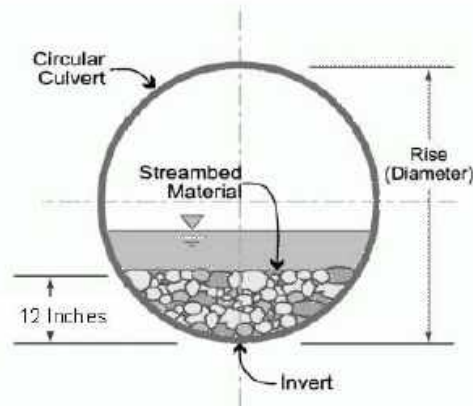

A waiver from the depth specifications in this condition may be requested, in writing, by the permittee and issued by the Corp. This waiver request must be specific as to the reason(s) for the request. The waiver will be issued if it can be demonstrated that the proposed design would result in less impacts to the aquatic environment. Culverts placed across wetland fills purely for the purposes of equalizing surface water do not have to be buried, but the culverts must be of adequate size and/or number to ensure unrestricted transmission of water.

b. Bank-full flows (or less) shall be accommodated through maintenance of the existing bank-full channel cross sectional area. Additional culverts or culvert barrels at such crossings shall be allowed only to receive bank-full flows.

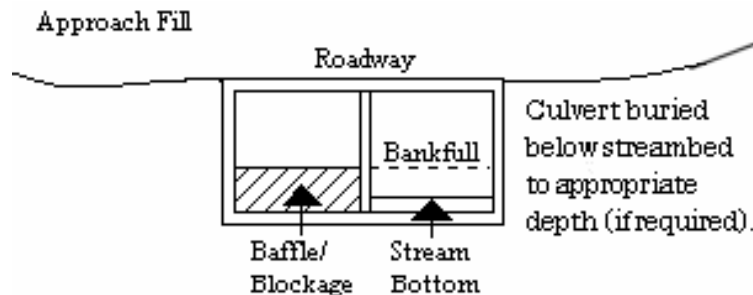

c. Culverts shall be designed and installed in such a manner that the original stream profiles are not altered and allow for aquatic life movement during low flows. The dimension, pattern, and profile of the stream above and below a pipe or culvert shall not be modified by widening the stream channel or by reducing the depth of the stream in connection with the construction activity. The width, height, and gradient of a proposed culvert shall be such as to pass the average historical low flow and spring flow without adversely altering flow velocity. If the width of the culvert is wider than the stream channel, the culvert shall include multiple boxes/pipes, baffles, benches and/or sills to maintain the natural width of the stream channel. If multiple culverts/pipes/barrels are used, low flows shall be accommodated in one culvert/pipe and additional culverts/pipes shall be installed such that they receive only flows above bankfull.

10. **Utility Lines.** For all NWP that allow for the construction and installation of utility lines, the following conditions shall be applied:

a. Utility lines consisting of aerial electric power transmission lines crossing navigable waters of the U.S. (which are defined at 33 CFR part 329) must comply with the applicable minimum clearances specified in 33 CFR 322.5(i).

b. The work area authorized by this permit, including temporary and/or permanent fills, will be minimized to the greatest extent practicable. Justification for work corridors exceeding forty (40) feet in width is required and will be based on pipeline diameter and length, size of equipment required to construct the utility line, and other construction information deemed necessary to support the request. The permittee is required to provide this information to the Corps with the initial PCN package.

c. A plan to restore and re-vegetate wetland areas cleared for construction must be submitted with the required PCN. Cleared wetland areas shall be re-vegetated, as appropriate, with species of canopy, shrub, and herbaceous species. The permittee shall not use fescue grass or any other species identified as invasive or exotic species by the NC Native Plant Society (NCNPS): <https://ncwildflower.org/invasive-exotic-species-list/>.

d. Any permanently maintained corridor along the utility right of way within forested wetlands shall be considered a loss of aquatic function. A compensatory mitigation plan will be required for all such impacts associated with the requested activity if the activity requires a PCN and the cumulative total of permanent conversion of forested wetlands exceeds 0.1 acres, unless the District Engineer determines in writing that either some other form of mitigation would be more environmentally appropriate or the adverse effects of the proposed activity are minimal.

Where permanently maintained corridor within forested wetlands is 0.1 acres or less, the District Engineer may determine, on a case-by-case basis, that compensatory mitigation is required to ensure that the activity results in minimal adverse effects on the aquatic environment.

e. When directional boring or horizontal directional drilling (HDD) under waters of the U.S., including wetlands, permittees shall closely monitor the project for hydraulic fracturing or “fracking.” Any discharge from hydraulic fracturing or “fracking” into waters of the U.S., including wetlands, shall be reported to the appropriate Corps Regulatory Field Office within 48 hours. Restoration and/or compensatory mitigation may be required as a result of any unintended discharges.

11. **Temporary Access Fills.** The permittee shall submit a PCN to the District Engineer prior to commencing the activity if the activity will involve the discharge of dredged or fill material into more than 0.1 acres of wetlands or 0.02 acres of stream channel for the construction of temporary access fills and/or temporary road crossings. The PCN must include a restoration plan that thoroughly describes how all temporary fills will be removed, how pre-project conditions will be restored, and include a timetable for all restoration activities.

12. **Federal Navigation Channel Setbacks.** Authorized structures and fills located in or adjacent to Federally authorized waterways must be constructed in accordance with the latest setback criteria established by the Wilmington District Engineer. You may review the setback policy at <http://www.saw.usace.army.mil/Missions/Navigation/Setbacks.aspx>. This general permit does not authorize the construction of hardened or permanently fixed structures within the Federally Authorized Channel Setback, unless the activity is approved by the Corps. The permittee shall submit a PCN (see General Condition 32) to the District Engineer to obtain a written verification prior to the construction of any structures or fills within the Federally Authorized Channel Setback.

13. **Northern Long-eared Bat – Endangered Species Act Compliance.** The Wilmington District, U.S. Army Corps of Engineers has consulted with the United States Fish and Wildlife

P-34

Nationwide Permit 3 - Activities, Regional Conditions, General Conditions, and Definitions

Service (USFWS) in regard to the threatened northern long-eared bat (NLEB) (*Myotis septentrionalis*) and Standard Local Operating Procedures for Endangered Species (SLOPES) have been approved by the Corps and the USFWS. This condition concerns effects to the NLEB only and does not address effects to other federally listed species and/or federally designated critical habitat.

a. Procedures when the Corps is the lead federal* agency for a project:

The permittee must comply with (1) and (2) below when:

- the project is located in the western 41 counties of North Carolina, to include non-federal aid North Carolina Department of Transportation (NCDOT) projects, OR;
- the project is located in the 59 eastern counties of North Carolina and is a non-NCDOT project.

*Generally, if a project is located on private property or on non-federal land, and the project is not being funded by a federal entity, the Corps will be the lead federal agency due to the requirement to obtain Department of the Army authorization to impact waters of the U.S. If the project is located on federal land, contact the Corps to determine the lead federal agency.

(1) A permittee using an NWP must check to see if their project is located in the range of the NLEB by using the following website:

<http://www.fws.gov/midwest/endangered/mammals/nleb/pdf/WNSZone.pdf>. If the project is within the range of the NLEB, or if the project includes percussive activities (e.g., blasting, pile driving, etc.), the permittee is then required to check the appropriate website in the paragraph below to discover if their project:

- is located in a 12-digit Hydrologic Unit Code area ("red HUC" - shown as red areas on the map), AND/OR;
- involves percussive activities within 0.25 mile of a red HUC.

Red HUC maps - for the western 41 counties in NC (covered by the Asheville Ecological Services Field Office), check the project location against the electronic maps found at: http://www.fws.gov/asheville/htmls/project_review/NLEB_in_WNC.html. For the eastern 59 counties in NC (covered by the Raleigh Ecological Services Field Office), check the project location against the electronic maps found at: https://www.fws.gov/raleigh/NLEB_RFO.html.

(2) A permittee must submit a PCN to the District Engineer, and receive written verification from the District Engineer, prior to commencing the activity, if the activity will involve any of the following:

- tree clearing/removal and/or, construction/installation of wind turbines in a red HUC, AND/OR;
- bridge removal or maintenance, unless the bridge has been inspected and there is no evidence of bat use, (applies anywhere in the range of the NLEB), AND/OR;
- percussive activities in a red HUC, or within 0.25 mile of a red HUC.

The permittee may proceed with the activity without submitting a PCN to either the Corps or the USFWS, provided the activity complies with all applicable NWP terms and general and regional conditions, if the permittee's review under A.(1) and A.(2) above shows that the project is:

- located outside of a red HUC (and there are no percussive activities), and the activity will NOT include bridge removal or maintenance, unless the bridge has been inspected and there is no evidence of bat use, OR;
- located outside of a red HUC and there are percussive activities, but the percussive activities will not occur within 0.25-mile of a red HUC boundary, and the activity will NOT include bridge removal or maintenance, unless the bridge has been inspected and there is no evidence of bat use, OR;
- located in a red HUC, but the activity will NOT include tree clearing/removal; construction/installation of wind turbines; bridge removal or maintenance, unless the bridge has been inspected and there is no evidence of bat use, and/or; any percussive activities.

b. Procedures when the USACE is not the lead federal agency:

For projects where another federal agency is the lead federal agency - if that other federal agency has completed project-specific ESA Section 7(a)(2) consultation for the NLEB, and has (1) determined that the project would not cause prohibited incidental take of the NLEB, and (2) completed coordination/consultation that is required by the USFWS (per the directions on the respective USFWS office's website), that project may proceed without PCN to either the USACE or the USFWS, provided all General and Regional Permit Conditions are met.

The NLEB SLOPES can be viewed on the USACE website at:

<http://www.saw.usace.army.mil/Missions/Regulatory-Permit-Program/Agency-Coordination/ESA/>. Permittees who do not have internet access may contact the USACE at (910) 251- 4633.

14. **West Indian Manatee Protection.** In order to protect the endangered West Indian manatee (*Trichechus manatus*) the Permittee shall implement the USFWS' Manatee Guidelines, and strictly adhere to all requirements therein. The guidelines can be found at <https://www.fws.gov/raleigh/pdfs/ManateeGuidelines2017.pdf>.

15. **ESA Programmatic Biological Opinions.** The Wilmington District, USFWS, NCDOT, and the FHWA have conducted programmatic Section 7(a)(2) consultation for a number of federally listed species and designated critical habitat (DCH), and programmatic consultation concerning other federally listed species and/or DCH may occur in the future. The result of completed programmatic consultation is a Programmatic Biological Opinion (PBO) issued by the USFWS. These PBOs contain mandatory terms and conditions to implement the reasonable and prudent measures that are associated with "incidental take" of whichever species or critical habitat is covered by a specific PBO. Authorization under NWPs is conditional upon the permittee's compliance with all the mandatory terms and conditions associated with incidental take of the applicable PBO (or PBOs), which are incorporated by reference in the NWPs. Failure to comply with the terms and conditions associated with incidental take of an applicable PBO, where a take of the federally listed species occurs, would constitute an unauthorized take by the permittee, and would also constitute permittee non-compliance with the authorization under the NWPs. If the terms and conditions of a specific PBO (or PBOs) apply to a project, the Corps will include this/these requirements in any NWP verification that may be issued for a project. For an activity/project that does not require a PCN, the terms and conditions of the applicable PBO(s) also apply to that non-notifying

activity/project. The USFWS is the appropriate authority to determine compliance with the terms and conditions of its PBO and the ESA. All PBOs can be found on our website at: <https://www.saw.usace.army.mil/Missions/Regulatory-Permit-Program/Agency-Coordination/ESA/>.

16. Work on Eastern Band of Cherokee Indian Land.

Notifying NWPs - All PCNs submitted for activities in waters of the U.S. on Eastern Band of Cherokee Indians (EBCI) trust land (i.e., Qualla Boundary and non-contiguous tracts of trust land located in portions of Swain, Jackson, Haywood, Graham and Cherokee Counties), must comply with the requirements of the latest MOU between the Wilmington District and the EBCI.

Non-notifying NWPs - Prior to the use of any non-notifying NWP for activities in waters of the U.S. on EBCI trust land (i.e., Qualla Boundary and non-contiguous tracts of trust land located in portions of Swain, Jackson, Haywood, Graham and Cherokee Counties), all prospective permittees must comply with the requirements of the latest MOU between the Wilmington District and the EBCI; this includes coordinating the proposed project with the EBCI Natural Resources Program and obtaining a Tribal Approval Letter from the Tribe.

The EBCI MOU can be found at the following URL: <http://saw-reg.usace.army.mil/FO/Final-MOU-EBCI-USACE.pdf>

17. Sedimentation and Erosion Control Structures and Measures.

All PCNs will identify and describe sedimentation and erosion control structures and measures proposed for placement in waters of the U.S. The structures and measures should be depicted on maps, surveys or drawings showing location and impacts to jurisdictional wetlands and streams.

C. REGIONAL CONDITIONS APPLICABLE TO NWP 3

1. In designated trout watersheds, a PCN is not required for impacts to a maximum of 0.02 acres for temporary dewatering) of streams and waterbodies when conducting maintenance activities. Minor deviations in an existing structure's configuration, temporary structures and temporary fills are authorized as part of the maintenance activity. In designated trout watersheds, the permittee shall submit a PCN (see Regional Condition C.3 above and General Condition 32) to the District Engineer prior to commencing the activity if; 1) impacts (other than temporary dewatering to work in dry conditions) to streams or waterbodies exceed 0.008 acres; 2) temporary impacts to streams or waterbodies associated with dewatering to work in dry conditions exceeds 0.02 acres; 3) the project will involve impacts to wetlands; 4) the project involves the replacement of a bridge or spanning structure with a culvert or non-spanning structure in waters of the United States; or 5) the activity will be constructed during the trout waters moratorium (October 15 through April 15).

D. SECTION 401 WATER QUALITY CERTIFICATION (WQC) AND/OR COASTAL ZONE MANAGEMENT ACT (CZMA) CONSISTENCY DETERMINATION SUMMARY AND APPLICABLE CONDITIONS

The CZMA Consistency Determination and all Water Quality Certifications for the NWP's can be found at: <https://www.saw.usace.army.mil/Missions/Regulatory-Permit-Program/Permits/2017-Nationwide-Permits/>

**STATE OF NORTH CAROLINA
DEPARTMENT OF ENVIRONMENTAL QUALITY
DIVISION OF WATER RESOURCES**

WATER QUALITY GENERAL CERTIFICATION NO. 4239

**GENERAL CERTIFICATION FOR PROJECTS ELIGIBLE FOR US ARMY CORPS OF ENGINEERS
NATIONWIDE PERMIT NUMBER 3 (MAINTENANCE)**

Water Quality General Certification Number 4239 is issued in conformity with the requirements of Section 401, Public Laws 92-500 and 95-217 of the United States and subject to the North Carolina Regulations in 15A NCAC 02H .0500 and 15A NCAC 02B .0200 for the discharge of fill material to surface waters and wetland areas as described in 33 CFR 330 Appendix A (B) (3) of the US Army Corps of Engineers regulations.

The State of North Carolina certifies that the specified category of activity will comply with water quality requirements and applicable portions of Sections 301, 302, 303, 306 and 307 of the Public Laws 92-500 and 95-217 if conducted in accordance with the conditions hereinafter set forth.

Effective date: February 25, 2022

Signed this day: December 18, 2020

By



S. Daniel Smith
Director

P-38
GC4239

GENERAL CERTIFICATION COVERAGE:

Activities that are eligible for US Army Corps of Engineers Nationwide Permit 3 qualify for coverage under this General Certification unless they meet one of the thresholds listed below. Activities meeting any one (1) of the thresholds or circumstances listed below are not eligible for coverage under this General Certification and require an Individual 401 Water Quality Certification from the Division of Water Resources (DWR):

- a) If any of the conditions of this General Certification cannot be met; or
- b) Total additional impacts to streams at an existing impact location greater than 40 linear feet; or
- c) Total additional impacts to wetlands or open waters at an existing impact location equal to or greater than one-tenth (1/10) acre; or
- d) Any impacts to streams from excavation or dredging other than excavation that is conducted as preparation for installing permanent fill or structures; or
- e) Any stream restoration or relocation; or
- f) Complete dewatering and drawdowns to a sediment layer related to pond/dam maintenance or removal unless the dewatering activity has been designed to ensure no discharge of sediment will occur into downstream waters AND has been covered by a Sediment and Erosion Control Plan Approval from the Division of Energy, Mineral, and Land Resources (DEMLR) or a delegated local program; or
- g) Any high-density project, as defined in 15A NCAC 02H .1003(3) and by the density thresholds specified in 15A NCAC 02H .1017, which:
 - i. Disturbs one acre or more of land (including a project that disturbs less than one acre of land that is part of a larger common plan of development or sale); and
 - ii. Has permanent wetland, stream, or open water impacts; and
 - iii. Is proposing new built-upon area; and
 - iv. Does not have a stormwater management plan reviewed and approved under a state stormwater program¹ or a state-approved local government stormwater program².

Projects that have vested rights, exemptions, or other legacy rights or exemptions from state or locally-implemented stormwater programs and projects that satisfy state or locally-implemented stormwater programs through use of community in-lieu fee programs **require an Individual 401 Certification**; or

- h) Any permanent impacts to coastal wetlands [15A NCAC 07H .0205], or Unique Wetlands (UWL) [15A NCAC 02B .0231]; or
- i) Any impacts to subject water bodies and/or state regulated riparian buffers along subject water bodies in the Neuse, Tar-Pamlico, or Catawba River Basins or in the Randleman Lake, Jordan Lake or Goose Creek Watersheds (or any other basin or

¹ e.g. Coastal Counties, HQW, ORW, or state-implemented Phase II NPDES

² e.g. Delegated Phase II NPDES, Water Supply Watershed, Nutrient-Sensitive Waters, or Universal Stormwater Management Program

P-39
GC4239

watershed with State Regulated Riparian Area Protection Rules [Buffer Rules] in effect at the time of application) *unless*:

- i. The activities are listed as “EXEMPT” or “DEEMED ALLOWABLE” from these rules;
or
- ii. A Buffer Authorization Certificate is issued by the NC Division of Coastal Management (DCM); or
- iii. A Buffer Authorization Certificate, Certificate with Exception, or Minor Variance is issued by a delegated or designated local government implementing a state riparian buffer program pursuant to 143-215.23.

In accordance with 15A NCAC 02H .0503(f), the Director of the North Carolina Division of Water Resources may require submission of a formal application for Individual Certification for any project if it is deemed in the public’s best interest or determined that the project is likely to have a significant adverse effect upon water quality, including state or federally listed endangered or threatened aquatic species, or will degrade the waters so that existing uses of the waters or downstream waters are precluded.

This General Certification does not relieve the permittee of the responsibility to obtain all other required Federal, State, or Local approvals before proceeding with the project, including those required by, but not limited to, Sediment and Erosion Control, Non-Discharge, Water Supply Watershed, and Trout Buffer regulations.

This General Certification neither grants nor affirms any property right, license, or privilege in any waters, or any right of use in any waters. This General Certification does not authorize any person to interfere with the riparian rights, littoral rights, or water use rights of any other person and does not create any prescriptive right or any right of priority regarding any usage of water. This General Certification shall not be interposed as a defense in any action respecting the determination of riparian or littoral rights or other rights to water use. No consumptive user is deemed by virtue of this General Certification to possess any prescriptive or other right of priority with respect to any other consumptive user regardless of the quantity of the withdrawal or the date on which the withdrawal was initiated or expanded.

Upon the presentation of proper credentials, DWR may inspect the property.

This General Certification shall expire on the same day as the expiration date of the corresponding Nationwide Permit. The conditions in effect on the date of issuance of Certification for a specific project shall remain in effect for the life of the project, regardless of the expiration date of this General Certification. This General Certification is rescinded when the US Army Corps of Engineers reauthorizes the corresponding Nationwide Permit or when deemed appropriate by the Director of the Division of Water Resources.

Non-compliance with or violation of the conditions herein set forth by a specific project may result in revocation of this General Certification for the project and may also result in criminal and/or civil penalties.

P-40
GC4239

I. ACTIVITY SPECIFIC CONDITIONS:

1. For all dam removal projects meeting the definition under G.S. 143-215.25 and requirements under G.S. 143-215.27 of a professionally supervised dam removal, the applicant shall provide documentation that any sediment that may be released has similar or lower level of contamination than sediment sampled from downstream of the dam in accordance with Session Law 2017-145.

Citation: 15A NCAC 02H .0506; 15A NCAC 02H .0507(c); 15A NCAC 02B .0200; 15A NCAC02B .0502

Justification: A project that affects waters shall not be permitted unless the existing uses, and the water quality to protect such uses, are protected. In determining that the proposed activity will comply with state water quality standards (including designated uses, numeric criteria, narrative criteria, and the state's antidegradation policy), the Division must evaluate if the activity has avoided and minimized impacts to waters, would cause or contribute to a violation of standards or would result in secondary or cumulative impacts.

II. GENERAL CONDITIONS:

1. The permittee shall report to the DWR Regional Office any noncompliance with, and/or any violation of, stream or wetland standards [15A NCAC 02B .0200], including but not limited to sediment impacts to streams or wetlands. Information shall be provided orally within 24 hours (or the next business day if a weekend or holiday) from the time the permittee became aware of the non-compliance circumstances.

Citation: 15A NCAC 02H .0506(b); 15A NCAC 02H .0507(c)

Justification: Timely reporting of non-compliance is important in identifying and minimizing detrimental impacts to water quality and avoiding impacts due to water pollution that precludes any best use on a short-term or long-term basis.

2. No waste, spoil, solids, or fill of any kind shall occur in wetlands or waters beyond the footprint of the impacts (including temporary impacts); or beyond the thresholds established for use of this General Certification and Nationwide Permit.

Citation: 15A NCAC 02H .0506; 15A NCAC 02H .0507(c)

Justification: Surface water quality standards require that conditions of waters be suitable for all best uses provided for in state rule (including, at minimum: aquatic life propagation, survival, and maintenance of biological integrity; wildlife; secondary contact recreation; agriculture); and that activities must not cause water pollution that precludes any best use on a short-term or long-term basis.

3. All activities shall be in compliance with any applicable State Regulated Riparian Buffer Rules in Chapter 2B of Title 15A in the North Carolina Administrative Code.

Citation: 15A NCAC 02H .0506(b); 15A NCAC 02H .0507(c)

P-41
GC4239

Justification: The referenced Riparian Buffer rules were adopted to address water quality impairments and further protect existing uses.

4. When applicable, all construction activities shall be performed and maintained in full compliance with G.S. Chapter 113A Article 4 (Sediment and Pollution Control Act of 1973). Regardless of applicability of the Sediment and Pollution Control Act, all projects shall incorporate appropriate Best Management Practices for the control of sediment and erosion so that no violations of state water quality standards, statutes, or rules occur.

Design, installation, operation, and maintenance of all sediment and erosion control measures shall be equal to or exceed the requirements specified in the most recent version of the *North Carolina Sediment and Erosion Control Manual*, or for linear transportation projects, the *North Carolina Department of Transportation Sediment and Erosion Control Manual*.

All devices shall be maintained on all construction sites, borrow sites, and waste pile (spoil) sites, including contractor-owned or leased borrow pits associated with the project. Sufficient materials required for stabilization and/or repair of erosion control measures and stormwater routing and treatment shall be on site at all times.

For borrow pit sites, the erosion and sediment control measures shall be designed, installed, operated, and maintained in accordance with the most recent version of the *North Carolina Surface Mining Manual*. Reclamation measures and implementation shall comply with the reclamation in accordance with the requirements of the Sedimentation Pollution Control Act and the Mining Act of 1971.

If the project occurs in waters or watersheds classified as Primary Nursery Areas (PNAs), SA, WS-I, WS-II, High Quality Waters (HQW), or Outstanding Resource Waters (ORW), then the sedimentation and erosion control designs shall comply with the requirements set forth in 15A NCAC 04B .0124, *Design Standards in Sensitive Watersheds*.

Citation: 15A NCAC 02H .0506(b)(2); 15A NCAC 02H .0507(c); 15A NCAC02B .0200; 15A NCAC 02B .0231

Justification: A project that affects waters shall not be permitted unless the existing uses, and the water quality to protect such uses, are protected. Activities must not cause water pollution that precludes any best use on a short-term or long-term basis. As cited in Stream Standards: (2) Oils, deleterious substances, or colored or other wastes: only such amounts as shall not render the waters injurious to public health, secondary recreation, or to aquatic life and wildlife, or adversely affect the palatability of fish, aesthetic quality, or impair the waters for any designated uses; and (12) turbidity in the receiving water shall not exceed 50 Nephelometric Turbidity Units (NTU) in streams not designated as trout waters and 10 NTU in streams, lakes, or reservoirs designated as trout waters; for lakes and reservoirs not designated as trout waters, the turbidity shall not exceed 25 NTU; if turbidity exceeds these levels due to natural background conditions, the existing turbidity level shall not be increased. As cited in Wetland Standards: (1) Liquids, fill or other solids, or dissolved gases shall not be present in amounts that may cause adverse impacts on existing wetland uses;

P-42
GC4239

and (3) Materials producing color or odor shall not be present in amounts that may cause adverse impacts on existing wetland uses.

5. Sediment and erosion control measures shall not be installed in wetland or waters except within the footprint of temporary or permanent impacts otherwise authorized by this Certification. If placed within authorized impact areas, then placement of such measures shall not be conducted in a manner that results in dis-equilibrium of any wetlands, streambeds, or streambanks. Any silt fence installed within wetlands shall be removed from wetlands and the natural grade restored within two (2) months of the date that DEMLR or locally delegated program has released the specific area within the project to ensure wetland standards are maintained upon completion of the project.

Citation: 15A NCAC 02H .0506(b); 15A NCAC 02H .0507(c); 15A NCAC02B .0200; 15A NCAC 02B .0231

Justification: A project that affects waters shall not be permitted unless the existing uses, and the water quality to protect such uses, are protected. Activities must not cause water pollution that precludes any best use on a short-term or long-term basis. As cited in Stream Standards: (2) Oils, deleterious substances, or colored or other wastes: only such amounts as shall not render the waters injurious to public health, secondary recreation, or to aquatic life and wildlife, or adversely affect the palatability of fish, aesthetic quality, or impair the waters for any designated uses; and (12) turbidity in the receiving water shall not exceed 50 Nephelometric Turbidity Units (NTU) in streams not designated as trout waters and 10 NTU in streams, lakes, or reservoirs designated as trout waters; for lakes and reservoirs not designated as trout waters, the turbidity shall not exceed 25 NTU; if turbidity exceeds these levels due to natural background conditions, the existing turbidity level shall not be increased. As cited in Wetland Standards: (1) Liquids, fill or other solids, or dissolved gases shall not be present in amounts that may cause adverse impacts on existing wetland uses; and (3) Materials producing color or odor shall not be present in amounts that may cause adverse impacts on existing wetland uses.

6. Erosion control matting that incorporates plastic mesh and/or plastic twine shall not be used along streambanks or within wetlands.

Citation: 15A NCAC 02H .0506(b); 15A NCAC 02H .0507(c)

Justification: A project that affects waters shall not be permitted unless the existing uses (including aquatic life propagation and biological integrity), and the water quality to protect such uses, are protected. Protections are necessary to ensure any remaining surface waters or wetlands, and any surface waters or wetlands downstream, continue to support existing uses during and after project completion. The Division must evaluate if the activity has avoided and minimized impacts to waters, would cause or contribute to a violation of standards, or would result in secondary or cumulative impacts.

7. If the project is covered by NPDES Construction Stormwater Permit Number NCG010000 or NPDES Construction Stormwater Permit Number NCG250000, full compliance with permit

P-43
GC4239

conditions including the erosion & sedimentation control plan, inspections and maintenance, self-monitoring, record keeping and reporting requirements is required.

The North Carolina Department of Transportation (NCDOT) shall be required to be in full compliance with the conditions related to construction activities within the most recent version of their Individual NPDES Stormwater Permit Number NCS000250.

Citation: 15A NCAC 02H .0506(b); 15A NCAC 02H .0507(c); 15A NCAC 02B .0200; 15A NCAC 02B .0231

Justification: A project that affects waters shall not be permitted unless the existing uses, and the water quality to protect such uses, are protected. Activities must not cause water pollution that precludes any best use on a short-term or long-term basis. As cited in Stream Standards: (2) Oils, deleterious substances, or colored or other wastes: only such amounts as shall not render the waters injurious to public health, secondary recreation, or to aquatic life and wildlife, or adversely affect the palatability of fish, aesthetic quality, or impair the waters for any designated uses; and (12) turbidity in the receiving water shall not exceed 50 Nephelometric Turbidity Units (NTU) in streams not designated as trout waters and 10 NTU in streams, lakes, or reservoirs designated as trout waters; for lakes and reservoirs not designated as trout waters, the turbidity shall not exceed 25 NTU; if turbidity exceeds these levels due to natural background conditions, the existing turbidity level shall not be increased. As cited in Wetland Standards: (1) Liquids, fill or other solids, or dissolved gases shall not be present in amounts that may cause adverse impacts on existing wetland uses; and (3) Materials producing color or odor shall not be present in amounts that may cause adverse impacts on existing wetland uses.

8. All work in or adjacent to streams shall be conducted so that the flowing stream does not come in contact with the disturbed area. Approved best management practices from the most current version of the *NC Sediment and Erosion Control Manual*, or the *NC Department of Transportation Construction and Maintenance Activities Manual*, such as sandbags, rock berms, cofferdams, and other diversion structures shall be used to minimize excavation in flowing water.

Citation: 15A NCAC 02H .0506(b); 15A NCAC 02H .0507(c); 15A NCAC 02B .0200

Justification: Surface water quality standards require that conditions of waters be suitable for all best uses provided for in state rule, and that activities must not cause water pollution that precludes any best use on a short-term or long-term basis. As cited in Stream Standards: (2) Oils, deleterious substances, or colored or other wastes: only such amounts as shall not render the waters injurious to public health, secondary recreation, or to aquatic life and wildlife, or adversely affect the palatability of fish, aesthetic quality, or impair the waters for any designated uses; and (12) turbidity in the receiving water shall not exceed 50 Nephelometric Turbidity Units (NTU) in streams not designated as trout waters and 10 NTU in streams, lakes, or reservoirs designated as trout waters; for lakes and reservoirs not designated as trout waters, the turbidity shall not exceed 25 NTU; if turbidity exceeds these levels due to natural background conditions, the existing turbidity level shall not be increased.

P-44
GC4239

9. If activities must occur during periods of high biological activity (e.g. sea turtle nesting, fish spawning, or bird nesting), then biological monitoring may be required at the request of other state or federal agencies and coordinated with these activities.

All moratoriums on construction activities established by the NC Wildlife Resources Commission (WRC), US Fish and Wildlife Service (USFWS), NC Division of Marine Fisheries (DMF), or National Marine Fisheries Service (NMFS) shall be implemented. Exceptions to this condition require written approval by the resource agency responsible for the given moratorium.

Work within a designated trout watershed of North Carolina (as identified by the Wilmington District of the US Army Corps of Engineers), or identified state or federal endangered or threatened species habitat, shall be coordinated with the appropriate WRC, USFWS, NMFS, and/or DMF personnel.

Citation: 15A NCAC 02H .0506(b); 15A NCAC 02H .0507(c); 15A NCAC 04B .0125

Justification: In order to protect against impairment of water quality standards and best usage of receiving and downstream waters, water quality based management practices must be employed to protect against direct or indirect discharge of waste or other sources of water pollution. Surface water quality standards require that conditions of waters be suitable for all best uses provided for in state rule (including, at minimum: aquatic life propagation, survival, and maintenance of biological integrity, wildlife, secondary contact recreation, agriculture), and that activities must not cause water pollution that precludes any best use on a short-term or long-term basis.

10. In-stream structures installed to mimic natural channel geomorphology such as cross-vanes, sills, step-pool structures, etc. shall be designed and installed in such a manner that allow for continued aquatic life movement.

Citation: 15A NCAC 02H .0506(b); 15A NCAC 02H .0507(c)

Justification: Surface water quality standards require that conditions of waters be suitable for all best uses provided for in state rule, and that activities must not cause water pollution that precludes any best use on a short-term or long-term basis. Ensuring that in-stream structures are installed properly will ensure that surface water quality standards are met and conditions of waters are suitable for all best uses.

11. Culverts shall be designed and installed in such a manner that the original stream profiles are not altered and allow for aquatic life movement during low flows. The dimension, pattern, and profile of the stream above and below a pipe or culvert shall not be modified by widening the stream channel or by reducing the depth of the stream in connection with the construction activity. The width, height, and gradient of a proposed culvert shall be such as to pass the average historical low flow and spring flow without adversely altering flow velocity. If the width of the culvert is wider than the stream channel, the culvert shall include multiple boxes/pipes, baffles, benches and/or sills to maintain the natural width of the stream channel. If multiple culverts/pipes/barrels are used, low flows shall be

P-45
GC4239

accommodated in one culvert/pipe and additional culverts/pipes shall be installed such that they receive only flows above bankfull.

Placement of culverts and other structures in streams shall be below the elevation of the streambed by one foot for all culverts with a diameter greater than 48 inches, and 20% of the culvert diameter for culverts having a diameter less than or equal to 48 inches, to allow low flow passage of water and aquatic life. If the culvert outlet is submerged within a pool or scour hole and designed to provide for aquatic passage, then culvert burial into the streambed is not required.

For structures less than 72" in diameter/width, and topographic constraints indicate culvert slopes of greater than 2.5% culvert burial is not required, provided that all alternative options for flattening the slope have been investigated and aquatic life movement/connectivity has been provided when possible (e.g. rock ladders, cross-vanes, sills, baffles etc.). Notification, including supporting documentation to include a location map of the culvert, culvert profile drawings, and slope calculations, shall be provided to DWR 30 calendar days prior to the installation of the culvert.

When bedrock is present in culvert locations, culvert burial is not required, provided that there is sufficient documentation of the presence of bedrock. Notification, including supporting documentation such as a location map of the culvert, geotechnical reports, photographs, etc. shall be provided to DWR a minimum of 30 calendar days prior to the installation of the culvert. If bedrock is discovered during construction, then DWR shall be notified by phone or email within 24 hours of discovery.

Installation of culverts in wetlands shall ensure continuity of water movement and be designed to adequately accommodate high water or flood conditions. When roadways, causeways, or other fill projects are constructed across FEMA-designated floodways or wetlands, openings such as culverts or bridges shall be provided to maintain the natural hydrology of the system as well as prevent constriction of the floodway that may result in destabilization of streams or wetlands.

The establishment of native woody vegetation and other soft stream bank stabilization techniques shall be used where practicable instead of rip-rap or other bank hardening methods.

Citation: 15A NCAC 02H .0506(b); 15A NCAC 02H .0507(c)

Justification: Surface water quality standards require that conditions of waters be suitable for all best uses provided for in state rule, and that activities must not cause water pollution that precludes any best use on a short-term or long-term basis. Ensuring that in-stream structures are installed properly will ensure that surface water quality standards are met and conditions of waters are suitable for all best uses.

12. Bridge deck drains shall not discharge directly into the stream. Stormwater shall be directed across the bridge and pre-treated through site-appropriate means to the maximum

P-46
GC4239

extent practicable (e.g. grassed swales, pre-formed scour holes, vegetated buffers, etc.) before entering the stream.

Citation: 15A NCAC 02H .0506(b); 15A NCAC 02H .0507(c)

Justification: Surface water quality standards require that conditions of waters be suitable for all best uses provided for in state rule and that activities must not cause water pollution that precludes any best use on a short-term or long-term basis. Ensuring that in-stream structures are installed properly will ensure that surface water quality standards are met and conditions of waters are suitable for all best uses.

13. Application of fertilizer to establish planted/seeded vegetation within disturbed riparian areas and/or wetlands shall be conducted at agronomic rates and shall comply with all other Federal, State and Local regulations. Fertilizer application shall be accomplished in a manner that minimizes the risk of contact between the fertilizer and surface waters.

Citation: 15A 02H .0506(b); 15A NCAC 02H .0507(c); 15A NCAC 02B .0231

Justification: A project that affects waters shall not be permitted unless the existing uses, and the water quality to protect such uses, are protected. Activities must not cause water pollution that precludes any best use on a short-term or long-term basis. As cited in Stream Standards: (2) Oils, deleterious substances, or colored or other wastes: only such amounts as shall not render the waters injurious to public health, secondary recreation, or to aquatic life and wildlife, or adversely affect the palatability of fish, aesthetic quality, or impair the waters for any designated uses.

14. If concrete is used during construction, then all necessary measures shall be taken to prevent direct contact between uncured or curing concrete and waters of the state. Water that inadvertently contacts uncured concrete shall not be discharged to waters of the state.

Citation: 15A 02H .0506(b); 15A NCAC 02H .0507(c); 15A NCAC 02B .0200

Justification: A project that affects waters shall not be permitted unless the existing uses, and the water quality to protect such uses, are protected. Activities must not cause water pollution that precludes any best use on a short-term or long-term basis. As cited in Stream Standards: (2) Oils, deleterious substances, or colored or other wastes: only such amounts as shall not render the waters injurious to public health, secondary recreation, or to aquatic life and wildlife, or adversely affect the palatability of fish, aesthetic quality, or impair the waters for any designated uses.

15. All proposed and approved temporary fill and culverts shall be removed and the impacted area shall be returned to natural conditions within 60 calendar days after the temporary impact is no longer necessary. The impacted areas shall be restored to original grade, including each stream's original cross-sectional dimensions, planform pattern, and longitudinal bed profile. All temporarily impacted sites shall be restored and stabilized with native vegetation.

Citation: 15A NCAC 02H.0506(b); 15A NCAC 02H .0507(c)

P-47
GC4239

Justification: A project that affects waters shall not be permitted unless the existing uses, and the water quality to protect such uses, are protected. Protections are necessary to ensure any remaining surface waters or wetlands, and any surface waters or wetlands downstream, continue to support existing uses after project completion.

16. All proposed and approved temporary pipes/culverts/rip-rap pads etc. in streams shall be installed as outlined in the most recent edition of the *North Carolina Sediment and Erosion Control Planning and Design Manual* or the *North Carolina Surface Mining Manual* or the *North Carolina Department of Transportation Best Management Practices for Construction and Maintenance Activities* so as not to restrict stream flow or cause dis-equilibrium during use of this General Certification.

Citation: 15A NCAC 02H .0506(b); 15A NCAC 02H .0507(c)

Justification: Surface water quality standards require that conditions of waters be suitable for all best uses provided for in state rule, and that activities must not cause water pollution that precludes any best use on a short-term or long-term basis. Ensuring that in-stream structures are installed properly will ensure that surface water quality standards are met and conditions of waters are suitable for all best uses.

17. Any rip-rap required for proper culvert placement, stream stabilization, or restoration of temporarily disturbed areas shall be restricted to the area directly impacted by the approved construction activity. All rip-rap shall be placed such that the original streambed elevation and streambank contours are restored and maintained and shall consist of clean rock or masonry material free of debris or toxic pollutants. Placement of rip-rap or other approved materials shall not result in de-stabilization of the stream bed or banks upstream or downstream of the area or be installed in a manner that precludes aquatic life passage.

Citation: 15A NCAC 02H .0506(b); 15A NCAC 02H .0507(c)

Justification: Surface water quality standards require that conditions of waters be suitable for all best uses provided for in state rule, and that activities must not cause water pollution that precludes any best use on a short-term or long-term basis. The Division must evaluate if the activity has avoided and minimized impacts to waters, would cause or contribute to a violation of standards, or would result in secondary or cumulative impacts.

18. Any rip-rap used for stream or shoreline stabilization shall be of a size and density to prevent movement by wave, current action, or stream flows, and shall consist of clean rock or masonry material free of debris or toxic pollutants. Rip-rap shall not be installed in the streambed except in specific areas required for velocity control and to ensure structural integrity of bank stabilization measures.

Citation: 15A NCAC 02H .0506(b); 15A NCAC 02H .0507(c); 15A NCAC 02B .0201

Justification: Surface water quality standards require that conditions of waters be suitable for all best uses provided for in state rule, and that activities must not cause water pollution that precludes any best use on a short-term or long-term basis. The Division must evaluate if the activity has avoided and minimized impacts to waters, would cause or contribute to a violation of standards, or would result in secondary or cumulative impacts.

P-48
GC4239

19. Rip-rap groins proposed in accordance with 15A NCAC 07H .1401 (NC Division of Coastal Management General Permit for construction of Wooden and Rip-rap Groins in Estuarine and Public Trust Waters) shall meet all the specific conditions for design and construction specified in 15A NCAC 07H .1405.

Citation: 15A NCAC 02H .0507(c); 15A NCAC 07H .1400 et seq.

Justification: Surface water quality standards require that conditions of waters be suitable for all best uses provided for in state rule, and that activities must not cause water pollution that precludes any best use on a short-term or long-term basis. The Division must evaluate if the activity has avoided and minimized impacts to waters, would cause or contribute to a violation of standards, or would result in secondary or cumulative impacts.

20. All mechanized equipment operated near surface waters shall be inspected and maintained regularly to prevent contamination of surface waters from fuels, lubricants, hydraulic fluids, or other toxic materials. Construction shall be staged in order to minimize the exposure of equipment to surface waters to the maximum extent practicable. Fueling, lubrication, and general equipment maintenance shall be performed in a manner to prevent, to the maximum extent practicable, contamination of surface waters by fuels and oils.

Citation: 15A NCAC 02H .0506(b); 15A NCAC 02H .0507(c); 15A NCAC 02B .0200

Justification: A project that affects waters shall not be permitted unless the existing uses, and the water quality to protect such uses, are protected. Activities must not cause water pollution that precludes any best use on a short-term or long-term basis. As cited in Stream Standards: (2) Oils, deleterious substances, or colored or other wastes: only such amounts as shall not render the waters injurious to public health, secondary recreation, or to aquatic life and wildlife, or adversely affect the palatability of fish, aesthetic quality, or impair the waters for any designated uses.

21. Heavy equipment working in wetlands shall be placed on mats or other measures shall be taken to minimize soil disturbance and compaction.

Citation: 15A NCAC 02H .0506(b); 15A NCAC 02H .0507(c); 15A NCAC 02B .0231

Justification: Wetland standards require maintenance or enhancement of existing uses of wetlands such that hydrologic conditions necessary to support natural biological and physical characteristics are protected; populations of wetland flora and fauna are maintained to protect biological integrity of the wetland; and materials or substances are not present in amounts that may cause adverse impact on existing wetland uses.

22. In accordance with 143-215.85(b), the permittee shall report any petroleum spill of 25 gallons or more; any spill regardless of amount that causes a sheen on surface waters; any petroleum spill regardless of amount occurring within 100 feet of surface waters; and any petroleum spill less than 25 gallons that cannot be cleaned up within 24 hours.

Citation: 15A NCAC 02H .0507(c); N.C.G.S 143-215.85(b)

Justification: Person(s) owning or having control over oil or other substances upon notice of discharge must immediately notify the Department, or any of its agents or employees, of the

P-49
GC4239

nature, location, and time of the discharge and of the measures which are being taken or are proposed to be taken to contain and remove the discharge. This action is required in order to contain or divert the substances to prevent entry into the surface waters. Surface water quality standards require that conditions of waters be suitable for all best uses provided for in state rule (including, at minimum: aquatic life propagation, survival, and maintenance of biological integrity; wildlife; secondary contact recreation; agriculture); and that activities must not cause water pollution that precludes any best use on a short-term or long-term basis.

23. The permittee and their authorized agents shall conduct all activities in a manner consistent with State water quality standards (including any requirements resulting from compliance with §303(d) of the Clean Water Act), and any other appropriate requirements of State and Federal Law.

Citation: 15A NCAC 02H .0506(b); 15A NCAC 02H .0507(c)

Justification: Surface water quality standards require that conditions of waters be suitable for all best uses provided for in state rule, and that activities must not cause water pollution that precludes any best use on a short-term or long-term basis. The Division must evaluate if the activity has avoided and minimized impacts to waters, would cause or contribute to a violation of standards, or would result in secondary or cumulative impacts.

24. The permittee shall require its contractors and/or agents to comply with the terms and conditions of this permit in the construction and maintenance of this project, and shall provide each of its contractors and/or agents associated with the construction or maintenance of this project with a copy of this General Certification. A copy of this General Certification shall be available at the project site during the construction and maintenance of this project.

Citation: 15A NCAC 02H .0506(b); 15A NCAC 02H .0507(c)

Justification: Those actually performing the work should be aware of the requirements of this 401 Water Quality General Certification to minimize water quality impacts.

History Note: Water Quality Certification (WQC) Number 4239 issued December 18, 2020 replaces WQC 4132 issued December 1, 2017 for activities eligible for USACE NWP3; WQC 3883 issued March 19, 2012; WQC 3687 issued November 1, 2007; WQC 3624 issued March 19, 2007; WQC 3494 issued December 31, 2004; and WQC 3376 issued March 18, 2002.

STATE	N.C.
FEDERAL PROJECT NUMBER	B-4654
PROJECT NUMBER	I
DESCRIPTION	PE
DATE	11/18/2019
BY	38454.1.2
DATE	38454.2.1
BY	RM & UTILITIES

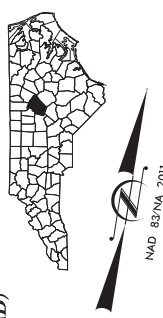

STATE OF NORTH CAROLINA
DIVISION OF HIGHWAYS
WAKE COUNTY

LOCATION: REPLACE BRIDGE 69 OVER US 70 ON NC 50 (BENSON ROAD)
TYPE OF WORK: GRADING, PAVING, DRAINAGE, RETAINING WALLS & STRUCTURES

WETLAND AND SURFACE WATER IMPACTS PERMIT
NOVEMBER 2018

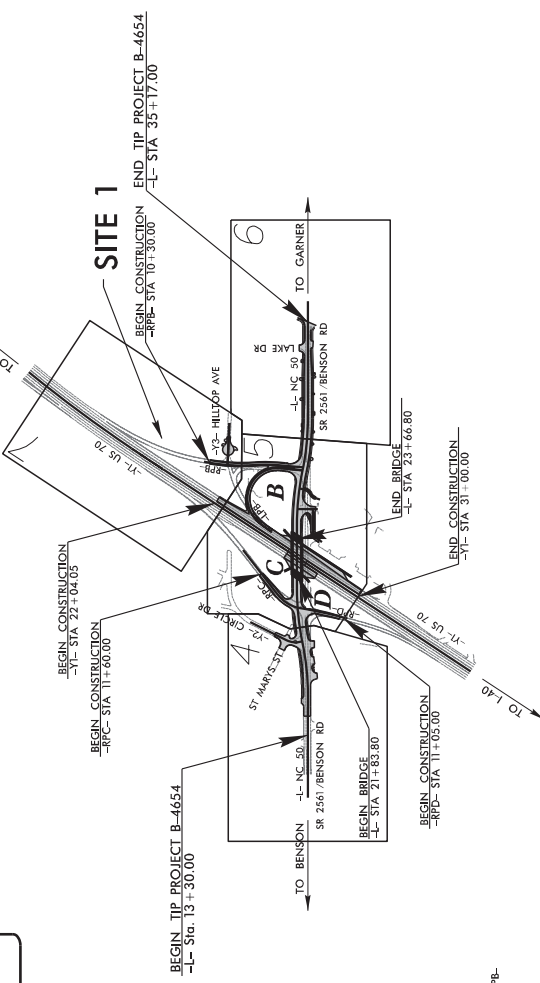
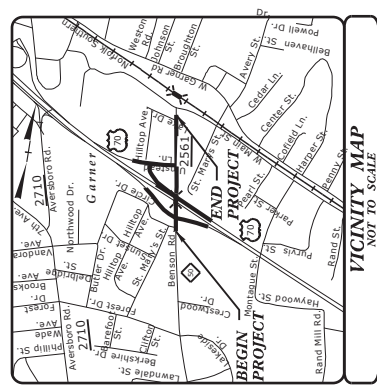

INCOMPLETE PLANS
DO NOT USE FOR CONSTRUCTION

PERMIT DRAWING
SHEET 01 OF 05

SUBMITTAL: RIGHT OF WAY PLANS
DATE: NOVEMBER 2, 2018

DOCUMENT NOT CONSIDERED FINAL
UNLESS FULLY IDENTIFIED AS SUCH



HYDRAULICS ENGINEER
SIGNATURE: _____
PROJECT DESIGN ENGINEER
DAVID S. STULTIS, PE
NIGHT CONTACT

Prepared in the Office of:
AECOM
1500 10th Street, Suite 475
Raleigh, NC 27601-5000
Project Engineer:
LAURA C. FISHER, PE
November 2, 2018
Project Design Engineer:
KIMBERLY A. KOVUNJEMI, PE
Letting Date:
June 18, 2019

PROJECT LENGTH

LENGTH ROADWAY TIP PROJECT B-4654	= 0.379 MILES
LENGTH BRIDGE TIP PROJECT B-4654	= 0.035 MILES
TOTAL LENGTH OF TIP PROJECT B-4654	= 0.414 MILES

DESIGN DATA

ADT 2015	= 13,100
ADT 2040	= 14,700
K	= 10%
D	= 55%
T	= 6%
V	= 40 MPH
* TTST = 1% DUAL 5%	
FUNC CLASS = MINOR ARTERIAL	
REGIONAL TIER	

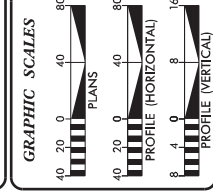

*DESIGN EXCEPTION REQUIRED FOR MIN. K VALUE ON -LIP-
US 70 IS A CONTROLLED ACCESS FACILITY WITHIN
THE PROJECT LIMITS
CLEARING ON THE PROJECT SHALL BE TO THE LIMITS
ESTABLISHED USING METHOD III.
THIS PROJECT IS WITHIN THE GARNER TOWN LIMITS

TIP PROJECT: B-4654

CONTRACT:

PROJECT REFERENCE NO. B-4654	SHEET NO. 7
DESIGNER ROBERTSON ENGINEER	DATE 11/11/2011

DOCUMENT NOT CONSIDERED FINAL
UNLESS ALL SIGNATURES COMPLETED

INCOMPLETE PLANS
DO NOT USE FOR CONSTRUCTION

PRELIMINARY PLANS
DO NOT USE FOR CONSTRUCTION

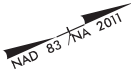

**PERMIT DRAWING
SHEET 02 OF 05**

MATCHLINE -Y1- STA. 31 + 05
SEE SHEET 5

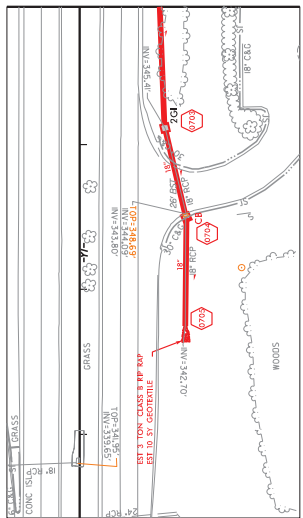

MATCHLINE -Y1- STA. 22 + 50
SEE SHEET 5

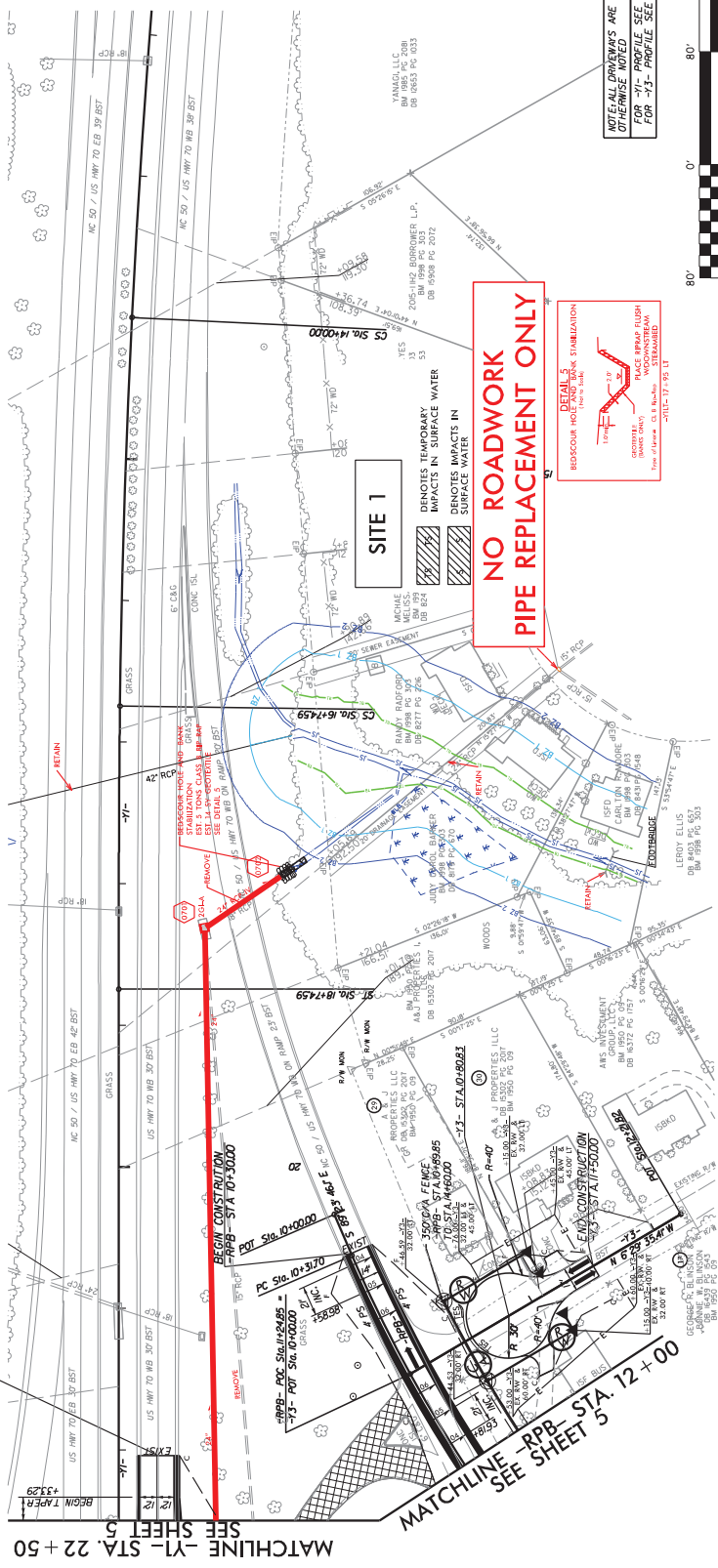

NOTE: ALL DRAWINGS ARE P UNLESS OTHERWISE NOTED - SEE SHEET 9 FOR -Y3- PROFILE SEE SHEET 10



PROJECT REFERENCE NO. B-4654	SHEET NO. 7
DESIGNER ROBERTSON ENGINEER	ENGINEER

DOCUMENT NOT CONSIDERED FINAL
UNLESS ALL SIGNATURES COMPLETED

INCOMPLETE PLANS
DO NOT USE FOR CONSTRUCTION

PRELIMINARY PLANS
DO NOT USE FOR CONSTRUCTION

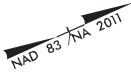

**PERMIT DRAWING
SHEET 03 OF 05**

MATCHLINE -Y1- STA. 31 + 05
SEE SHEET 5

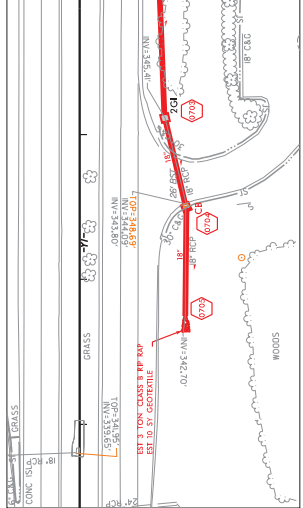

MATCHLINE -Y1- STA. 22 + 50
SEE SHEET 5

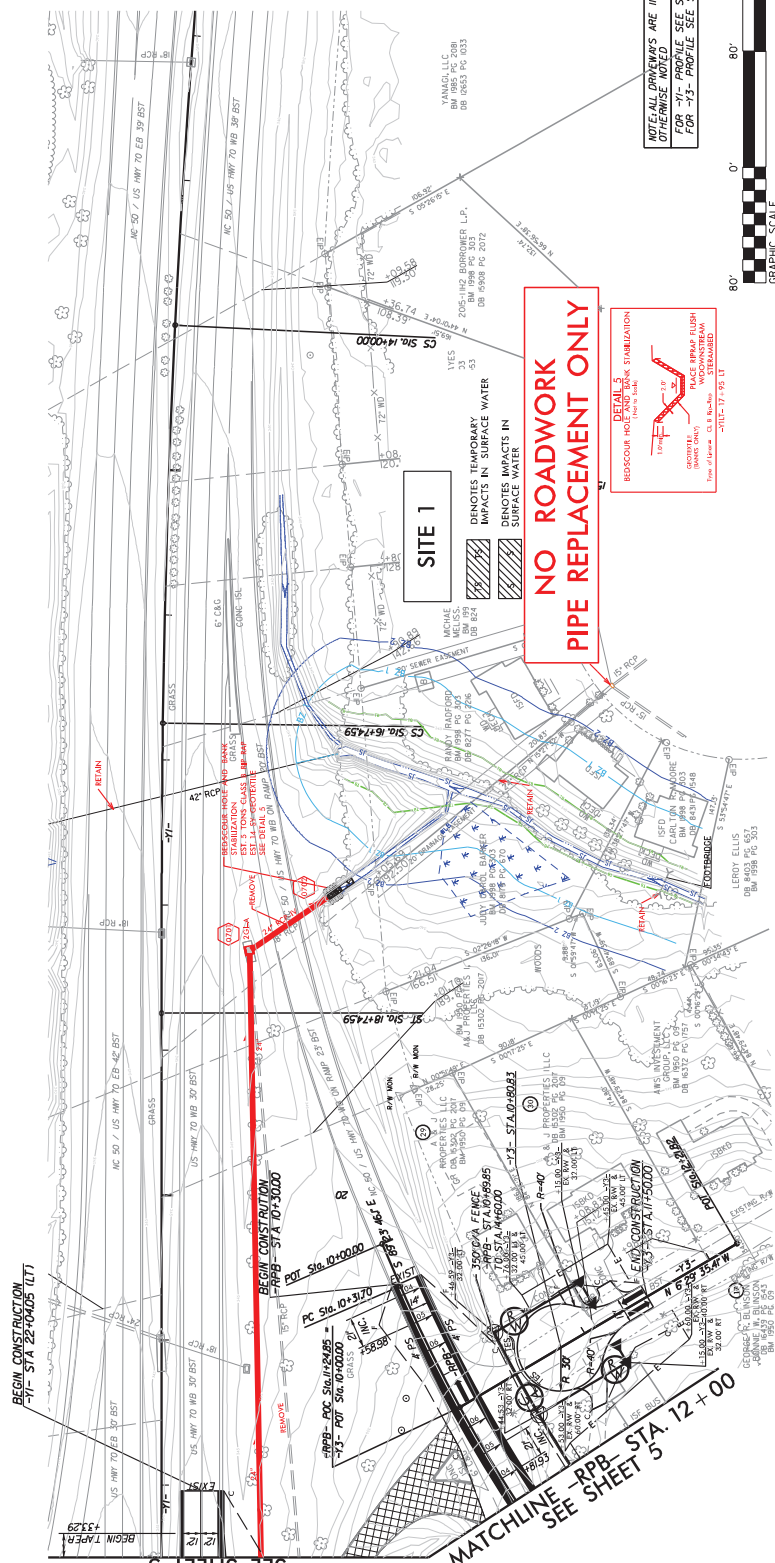

NOTE: ALL DRIVERS ARE IF UNLESS OTHERWISE NOTED
FOR -Y1- PROFILE SEE SHEET 9
FOR -Y2- PROFILE SEE SHEET 10

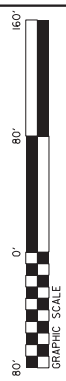

County: WAKE

Line #	Item Number	Sec #	Description	Quantity	Unit Cost	Amount
ROADWAY ITEMS						
0001	0000100000-N	800	MOBILIZATION	Lump Sum	L.S.	
0002	0000400000-N	801	CONSTRUCTION SURVEYING	Lump Sum	L.S.	
0003	0043000000-N	226	GRADING	Lump Sum	L.S.	
0004	0050000000-E	226	SUPPLEMENTARY CLEARING & GRUBBING	1 ACR		
0005	0057000000-E	226	UNDERCUT EXCAVATION	400 CY		
0006	0195000000-E	265	SELECT GRANULAR MATERIAL	400 CY		
0007	0196000000-E	270	GEOTEXTILE FOR SOIL STABILIZATION	500 SY		
0008	0199000000-E	SP	TEMPORARY SHORING	3,900 SF		
0009	0248000000-N	SP	GENERIC GRADING ITEM TYPE 2 BRIDGE APPROACH FILL, STA 22+71.80 -L-	Lump Sum	L.S.	
0010	0255000000-E	SP	GENERIC GRADING ITEM HAULING AND DISPOSAL OF PETROLEUM CONTAMINATED SOIL.	50 TON		
0011	0318000000-E	300	FOUNDATION CONDITIONING MATERIAL, MINOR STRUCTURES	621 TON		
0012	0321000000-E	300	FOUNDATION CONDITIONING GEOTEXTILE	3,446 SY		
0013	0335200000-E	305	15" DRAINAGE PIPE	1,180 LF		
0014	0335300000-E	305	18" DRAINAGE PIPE	272 LF		
0015	0335400000-E	305	24" DRAINAGE PIPE	552 LF		
0016	0354000000-E	310	**** RC PIPE CULVERTS, CLASS ***** (18", V)	440 LF		
0017	0448200000-E	310	15" RC PIPE CULVERTS, CLASS IV	1,768 LF		

County: WAKE

Line #	Item Number	Sec #	Description	Quantity	Unit Cost	Amount
0018	0448300000-E	310	18" RC PIPE CULVERTS, CLASS IV	160 LF		
0019	0448400000-E	310	24" RC PIPE CULVERTS, CLASS IV	64 LF		
0020	0582000000-E	310	15" CS PIPE CULVERTS, 0.064" THICK	132 LF		
0021	0636000000-E	310	*** CS PIPE ELBOWS, ***** THICK (15", 0.064")	8 EA		
0022	0995000000-E	340	PIPE REMOVAL	1,241 LF		
0023	1099500000-E	505	SHALLOW UNDERCUT	200 CY		
0024	1099700000-E	505	CLASS IV SUBGRADE STABILIZATION	400 TON		
0025	1112000000-E	505	GEOTEXTILE FOR SUBGRADE STABILIZATION	600 SY		
0026	1121000000-E	520	AGGREGATE BASE COURSE	32 TON		
0027	1220000000-E	545	INCIDENTAL STONE BASE	150 TON		
0028	1330000000-E	607	INCIDENTAL MILLING	2,750 SY		
0029	1491000000-E	610	ASPHALT CONC BASE COURSE, TYPE B25.0C	3,270 TON		
0030	1503000000-E	610	ASPHALT CONC INTERMEDIATE COURSE, TYPE I19.0C	2,330 TON		
0031	1519000000-E	610	ASPHALT CONC SURFACE COURSE, TYPE S9.5B	1,680 TON		
0032	1523000000-E	610	ASPHALT CONC SURFACE COURSE, TYPE S9.5C	1,350 TON		
0033	1575000000-E	620	ASPHALT BINDER FOR PLANT MIX	450 TON		
0034	1693000000-E	654	ASPHALT PLANT MIX, PAVEMENT REPAIR	315 TON		

County: WAKE

Line #	Item Number	Sec #	Description	Quantity	Unit Cost	Amount
0035	1891000000-E	SP	GENERIC PAVING ITEM 6" CONCRETE TRUCK APRON	78 SY		
0036	2000000000-N	806	RIGHT-OF-WAY MARKERS	4 EA		
0037	2020000000-N	806	CONTROL-OF-ACCESS MARKERS	14 EA		
0038	2022000000-E	815	SUBDRAIN EXCAVATION	369.6 CY		
0039	2026000000-E	815	GEOTEXTILE FOR SUBSURFACE DRAINS	2,200 SY		
0040	2036000000-E	815	SUBDRAIN COARSE AGGREGATE	369.6 CY		
0041	2044000000-E	815	6" PERFORATED SUBDRAIN PIPE	2,200 LF		
0042	2070000000-N	815	SUBDRAIN PIPE OUTLET	5 EA		
0043	2077000000-E	815	6" OUTLET PIPE	30 LF		
0044	2275000000-E	SP	FLOWABLE FILL	5 CY		
0045	2286000000-N	840	MASONRY DRAINAGE STRUCTURES	49 EA		
0046	2308000000-E	840	MASONRY DRAINAGE STRUCTURES	4.8 LF		
0047	2364000000-N	840	FRAME WITH TWO GRATES, STD 840.16	1 EA		
0048	2364200000-N	840	FRAME WITH TWO GRATES, STD 840.20	4 EA		
0049	2365000000-N	840	FRAME WITH TWO GRATES, STD 840.22	5 EA		
0050	2366000000-N	840	FRAME WITH TWO GRATES, STD 840.24	9 EA		
0051	2374000000-N	840	FRAME WITH GRATE & HOOD, STD 840.03, TYPE ** (E)	3 EA		

County: WAKE

Line #	Item Number	Sec #	Description	Quantity	Unit Cost	Amount
0052	2374000000-N	840	FRAME WITH GRATE & HOOD, STD 840.03, TYPE ** (F)	10 EA		
0053	2374000000-N	840	FRAME WITH GRATE & HOOD, STD 840.03, TYPE ** (G)	14 EA		
0054	2396000000-N	840	FRAME WITH COVER, STD 840.54	6 EA		
0055	2407000000-N	840	STEEL FRAME WITH TWO GRATES, STD 840.37	1 EA		
0056	2542000000-E	846	1'-6" CONCRETE CURB & GUTTER	170 LF		
0057	2549000000-E	846	2'-6" CONCRETE CURB & GUTTER	4,230 LF		
0058	2570000000-N	SP	MODIFIED CONCRETE FLUME	1 EA		
0059	2591000000-E	848	4" CONCRETE SIDEWALK	1,630 SY		
0060	2605000000-N	848	CONCRETE CURB RAMPS	27 EA		
0061	2612000000-E	848	6" CONCRETE DRIVEWAY	310 SY		
0062	2619000000-E	850	4" CONCRETE PAVED DITCH	200 SY		
0063	2655000000-E	852	5" MONOLITHIC CONCRETE ISLANDS (KEYED IN)	170 SY		
0064	2724000000-E	857	PRECAST REINFORCED CONCRETE BARRIER, SINGLE FACED	580 LF		
0065	2938000000-N	859	CONVERT EXISTING DROP INLET TO JUNCTION BOX WITH MANHOLE	1 EA		
0066	3001000000-N	SP	IMPACT ATTENUATOR UNITS, TYPE TL-3	2 EA		
0067	3030000000-E	862	STEEL BEAM GUARDRAIL	300 LF		
0068	3045000000-E	862	STEEL BEAM GUARDRAIL, SHOP CURVED	25 LF		

County: WAKE

Line #	Item Number	Sec #	Description	Quantity	Unit Cost	Amount
0069	3105000000-N	862	STEEL BEAM GUARDRAIL TERMINAL SECTIONS (TES)	2 EA		
0070	3215000000-N	862	GUARDRAIL ANCHOR UNITS, TYPE III	2 EA		
0071	3288000000-N	862	GUARDRAIL END UNITS, TYPE TL-2	2 EA		
0072	3317000000-N	862	GUARDRAIL ANCHOR UNITS, TYPE B-77	4 EA		
0073	3500000000-E	866	WOVEN WIRE FENCE, *** FABRIC (48")	370 LF		
0074	3506000000-E	866	4" TIMBER FENCE POSTS, ***** LONG (48")	27 EA		
0075	3649000000-E	876	RIP RAP, CLASS B	30 TON		
0076	3656000000-E	876	GEOTEXTILE FOR DRAINAGE	620 SY		
0077	4054000000-E	902	PLAIN CONCRETE SIGN FOUNDATIONS	1 CY		
0078	4060000000-E	903	SUPPORTS, BREAKAWAY STEEL BEAM	449 LB		
0079	4072000000-E	903	SUPPORTS, 3-LB STEEL U-CHANNEL	860 LF		
0080	4096000000-N	904	SIGN ERECTION, TYPE D	6 EA		
0081	4102000000-N	904	SIGN ERECTION, TYPE E	25 EA		
0082	4108000000-N	904	SIGN ERECTION, TYPE F	10 EA		
0083	4110000000-N	904	SIGN ERECTION, TYPE *** (GROUND MOUNTED) (B)	3 EA		
0084	4116100000-N	904	SIGN ERECTION, RELOCATE TYPE **** (GROUND MOUNTED) (D)	1 EA		
0085	4155000000-N	907	DISPOSAL OF SIGN SYSTEM, U-CHANNEL	51 EA		

County: WAKE

Line #	Item Number	Sec #	Description	Quantity	Unit Cost	Amount
0086	4400000000-E	1110	WORK ZONE SIGNS (STATIONARY)	1,011 SF		
0087	4405000000-E	1110	WORK ZONE SIGNS (PORTABLE)	172 SF		
0088	4410000000-E	1110	WORK ZONE SIGNS (BARRICADE MOUNTED)	95 SF		
0089	4415000000-N	1115	FLASHING ARROW BOARD	2 EA		
0090	4420000000-N	1120	PORTABLE CHANGEABLE MESSAGE SIGN	4 EA		
0091	4430000000-N	1130	DRUMS	120 EA		
0092	4435000000-N	1135	CONES	60 EA		
0093	4445000000-E	1145	BARRICADES (TYPE III)	264 LF		
0094	4455000000-N	1150	FLAGGER	360 DAY		
0095	4465000000-N	1160	TEMPORARY CRASH CUSHIONS	4 EA		
0096	4480000000-N	1165	TMA	2 EA		
0097	4485000000-E	1170	PORTABLE CONCRETE BARRIER	1,530 LF		
0098	4490000000-E	1170	PORTABLE CONCRETE BARRIER (ANCHORED)	950 LF		
0099	4505000000-E	1170	REMOVE & RESET PORTABLE CONCRETE BARRIER (ANCHORED)	520 LF		
0100	4510000000-N	1190	LAW ENFORCEMENT	160 HR		
0101	4516000000-N	1180	SKINNY DRUM	40 EA		
0102	4650000000-N	1251	TEMPORARY RAISED PAVEMENT MARKERS	115 EA		

County: WAKE

Line #	Item Number	Sec #	Description	Quantity	Unit Cost	Amount
0103	4695000000-E	1205	THERMOPLASTIC PAVEMENT MARKING LINES (8", 90 MILS)	832 LF		
0104	4709000000-E	1205	THERMOPLASTIC PAVEMENT MARKING LINES (24", 90 MILS)	200 LF		
0105	4720000000-E	1205	THERMOPLASTIC PAVEMENT MARKING CHARACTER (90 MILS)	4 EA		
0106	4725000000-E	1205	THERMOPLASTIC PAVEMENT MARKING SYMBOL (90 MILS)	19 EA		
0107	4770000000-E	1205	COLD APPLIED PLASTIC PAVEMENT MARKING LINES, TYPE ** (4") (IV)	555 LF		
0108	4810000000-E	1205	PAINT PAVEMENT MARKING LINES (4")	29,917 LF		
0109	4820000000-E	1205	PAINT PAVEMENT MARKING LINES (8")	156 LF		
0110	4835000000-E	1205	PAINT PAVEMENT MARKING LINES (24")	80 LF		
0111	4845000000-N	1205	PAINT PAVEMENT MARKING SYMBOL	3 EA		
0112	4846000000-E	1205	POLYUREA PAVEMENT MARKING LINES (***, *** MILS) (4", 20 MILS)	9,894 LF		
0113	4846000000-E	1205	POLYUREA PAVEMENT MARKING LINES (***, *** MILS) (4", 30 MILS)	472 LF		
0114	4846000000-E	1205	POLYUREA PAVEMENT MARKING LINES (***, *** MILS) (6", 20 MILS)	72 LF		
0115	4846000000-E	1205	POLYUREA PAVEMENT MARKING LINES (***, *** MILS) (8", 20 MILS)	159 LF		
0116	4850000000-E	1205	REMOVAL OF PAVEMENT MARKING LINES (4")	6,651 LF		
0117	4900000000-N	1251	PERMANENT RAISED PAVEMENT MARKERS	4 EA		
0118	4905100000-N	1253	NON-CAST IRON SNOWPLOWABLE PAVEMENT MARKER	157 EA		

County: WAKE

Line #	Item Number	Sec #	Description	Quantity	Unit Cost	Amount
0119	5150000000-E	1409	ELECTRICAL DUCT, TYPE **, SIZE ***** (JA, 2")	350 LF		
0120	5155000000-E	1409	ELECTRICAL DUCT, TYPE BD, SIZE ***** (2")	3,750 LF		
0121	5240000000-N	1411	ELECTRICAL JUNCTION BOXES ***** (IG18)	2 EA		
0122	5240000000-N	1411	ELECTRICAL JUNCTION BOXES ***** (IG30)	4 EA		
0123	5255000000-N	1413	PORTABLE LIGHTING	Lump Sum	L.S.	
0124	5260000000-N	SP	GENERIC LIGHTING ITEM ELECTRICAL CONDUIT SYSTEM AT STATION 22+71.80-L-	Lump Sum	L.S.	
0125	5319000000-E	1505	CLASS B CONCRETE FOR ENCASING UTILITY LINES	3 CY		
0126	5325600000-E	1510	6" WATER LINE	190 LF		
0127	5325800000-E	1510	8" WATER LINE	568 LF		
0128	5326000000-E	1510	10" WATER LINE	1,706 LF		
0129	5329000000-E	1510	DUCTILE IRON WATER PIPE FITTINGS	6,815 LB		
0130	5540000000-E	1515	6" VALVE	6 EA		
0131	5546000000-E	1515	8" VALVE	3 EA		
0132	5552000000-E	1515	10" VALVE	7 EA		
0133	5562000000-E	1515	*** INSERTION VALVE (10")	1 EA		
0134	5562000000-E	1515	*** INSERTION VALVE (6")	2 EA		

County: WAKE

Line #	Item Number	Sec #	Description	Quantity	Unit Cost	Amount
0135	5562000000-E	1515	*** INSERTION VALVE (8")	3 EA		
0136	5648000000-N	1515	RELOCATE WATER METER	14 EA		
0137	5666000000-N	1515	FIRE HYDRANT	3 EA		
0138	5672000000-N	1515	RELOCATE FIRE HYDRANT	2 EA		
0139	5673000000-E	1515	FIRE HYDRANT LEG	62 LF		
0140	5686000000-E	1515	*** WATER SERVICE LINE (1")	363 LF		
0141	5768000000-N	1520	SANITARY SEWER CLEAN-OUT	1 EA		
0142	5768500000-E	1520	SEWER SERVICE LINE	10 LF		
0143	5769000000-E	1520	DUCTILE IRON SEWER PIPE FITTINGS	45 LB		
0144	5777000000-E	1525	6' DIA UTILITY MANHOLE	1 EA		
0145	5783000000-E	1525	UTILITY MANHOLE WALL 6' DIA	3 LF		
0146	5800000000-E	1530	ABANDON 6" UTILITY PIPE	50 LF		
0147	5801000000-E	1530	ABANDON 8" UTILITY PIPE	871 LF		
0148	5802000000-E	1530	ABANDON 10" UTILITY PIPE	1,622 LF		
0149	5815000000-N	1530	REMOVE WATER METER	4 EA		
0150	5828000000-N	1530	REMOVE UTILITY MANHOLE	3 EA		
0151	5835700000-E	1540	16" ENCASEMENT PIPE	20 LF		

County: WAKE

Line #	Item Number	Sec #	Description	Quantity	Unit Cost	Amount
0152	5835900000-E	1540	20" ENCASMENT PIPE	164 LF		
0153	5872500000-E	1550	BORE AND JACK OF *** (20")	164 LF		
0154	6000000000-E	1605	TEMPORARY SILT FENCE	4,820 LF		
0155	6006000000-E	1610	STONE FOR EROSION CONTROL, CLASS A	630 TON		
0156	6009000000-E	1610	STONE FOR EROSION CONTROL, CLASS B	335 TON		
0157	6012000000-E	1610	SEDIMENT CONTROL STONE	775 TON		
0158	6015000000-E	1615	TEMPORARY MULCHING	9 ACR		
0159	6018000000-E	1620	SEED FOR TEMPORARY SEEDING	600 LB		
0160	6021000000-E	1620	FERTILIZER FOR TEMPORARY SEEDING	4 TON		
0161	6024000000-E	1622	TEMPORARY SLOPE DRAINS	200 LF		
0162	6029000000-E	SP	SAFETY FENCE	440 LF		
0163	6030000000-E	1630	SILT EXCAVATION	1,040 CY		
0164	6036000000-E	1631	MATTING FOR EROSION CONTROL	11,700 SY		
0165	6037000000-E	1629	COIR FIBER MAT	100 SY		
0166	6042000000-E	1632	1/4" HARDWARE CLOTH	1,160 LF		
0167	6043000000-E	1644	LOW PERMEABILITY GEOTEXTILE	100 SY		
0168	6070000000-N	1639	SPECIAL STILLING BASINS	1 EA		

County: WAKE

Line #	Item Number	Sec #	Description	Quantity	Unit Cost	Amount
0169	6071002000-E	1642	FLOCCULANT	220 LB		
0170	6071012000-E	1642	COIR FIBER WATTLE	650 LF		
0171	6071030000-E	1640	COIR FIBER BAFFLE	75 LF		
0172	6071050000-E	1644	*** SKIMMER (1-1/2")	1 EA		
0173	6084000000-E	1660	SEEDING & MULCHING	9 ACR		
0174	6087000000-E	1660	MOWING	4.5 ACR		
0175	6090000000-E	1661	SEED FOR REPAIR SEEDING	100 LB		
0176	6093000000-E	1661	FERTILIZER FOR REPAIR SEEDING	0.25 TON		
0177	6096000000-E	1662	SEED FOR SUPPLEMENTAL SEEDING	175 LB		
0178	6108000000-E	1665	FERTILIZER TOPDRESSING	5.25 TON		
0179	6114500000-N	1667	SPECIALIZED HAND MOWING	10 MHR		
0180	6114800000-N	SP	MANUAL LITTER REMOVAL	4 MHR		
0181	6114900000-E	SP	LITTER DISPOSAL	1 TON		
0182	6117000000-N	1675	RESPONSE FOR EROSION CONTROL	18 EA		
0183	6117500000-N	SP	CONCRETE WASHOUT STRUCTURE	2 EA		
0184	6132000000-N	SP	GENERIC EROSION CONTROL ITEM FABRIC INSERT INLET PROTECTION - (TYPE 2)	3 EA		
0185	6132000000-N	SP	GENERIC EROSION CONTROL ITEM FABRIC INSERT INLET PROTECTION CLEANOUT	6 EA		

County: WAKE

Line #	Item Number	Sec #	Description	Quantity	Unit Cost	Amount
0186	7048500000-E	1705	PEDESTRIAN SIGNAL HEAD (16", 1 SECTION W/COUNTDOWN)	10 EA		
0187	7060000000-E	1705	SIGNAL CABLE	3,510 LF		
0188	7120000000-E	1705	VEHICLE SIGNAL HEAD (12", 3 SECTION)	22 EA		
0189	7132000000-E	1705	VEHICLE SIGNAL HEAD (12", 4 SECTION)	1 EA		
0190	7264000000-E	1710	MESSENGER CABLE (3/8")	500 LF		
0191	7288000000-E	1715	PAVED TRENCHING (*****) (1, 2")	25 LF		
0192	7300000000-E	1715	UNPAVED TRENCHING (*****) (1, 2")	760 LF		
0193	7300000000-E	1715	UNPAVED TRENCHING (*****) (2, 2")	150 LF		
0194	7300000000-E	1715	UNPAVED TRENCHING (*****) (3, 2")	50 LF		
0195	7301000000-E	1715	DIRECTIONAL DRILL (*****) (2, 2")	1,425 LF		
0196	7324000000-N	1716	JUNCTION BOX (STANDARD SIZE)	11 EA		
0197	7348000000-N	1716	JUNCTION BOX (OVER-SIZED, HEAVY DUTY)	8 EA		
0198	7360000000-N	1720	WOOD POLE	4 EA		
0199	7372000000-N	1721	GUY ASSEMBLY	16 EA		
0200	7408000000-E	1722	1" RISER WITH WEATHERHEAD	1 EA		
0201	7420000000-E	1722	2" RISER WITH WEATHERHEAD	3 EA		
0202	7432000000-E	1722	2" RISER WITH HEAT SHRINK TUBING	1 EA		

County: WAKE

Line #	Item Number	Sec #	Description	Quantity	Unit Cost	Amount
0203	7444000000-E	1725	INDUCTIVE LOOP SAWCUT	1,100 LF		
0204	7456100000-E	1726	LEAD-IN CABLE (14-2)	3,350 LF		
0205	7516000000-E	1730	COMMUNICATIONS CABLE (** FIBER) (12)	260 LF		
0206	7516000000-E	1730	COMMUNICATIONS CABLE (** FIBER) (24)	700 LF		
0207	7528000000-E	1730	DROP CABLE	200 LF		
0208	7540000000-N	1731	SPLICE ENCLOSURE	1 EA		
0209	7541000000-N	1731	MODIFY SPLICE ENCLOSURE	1 EA		
0210	7552000000-N	1731	INTERCONNECT CENTER	1 EA		
0211	7566000000-N	1733	DELINEATOR MARKER	1 EA		
0212	7588000000-N	SP	METAL POLE WITH SINGLE MAST ARM	6 EA		
0213	7613000000-N	SP	SOIL TEST	6 EA		
0214	7614100000-E	SP	DRILLED PIER FOUNDATION	36 CY		
0215	7631000000-N	SP	MAST ARM WITH METAL POLE DESIGN	6 EA		
0216	7636000000-N	1745	SIGN FOR SIGNALS	4 EA		
0217	7642100000-N	1743	TYPE I POST WITH FOUNDATION	3 EA		
0218	7642200000-N	1743	TYPE II PEDESTAL WITH FOUNDATION	5 EA		
0219	7684000000-N	1750	SIGNAL CABINET FOUNDATION	2 EA		

County: WAKE

Line #	Item Number	Sec #	Description	Quantity	Unit Cost	Amount
0220	7696000000-N	1751	CONTROLLERS WITH CABINET (***** (TYPE 2070LX, BASE MOUNTED)	2 EA		
0221	7744000000-N	1751	DETECTOR CARD (TYPE 170)	8 EA		
0222	7901000000-N	1753	CABINET BASE EXTENDER	2 EA		
0223	7980000000-N	SP	GENERIC SIGNAL ITEM ETHERNET EDGE SWITCH	1 EA		
0224	7980000000-N	SP	GENERIC SIGNAL ITEM MICROWAVE VEHICLE DETECTION SYSTEM - MULTIPLE ZONES	1 EA		
0225	7980000000-N	SP	GENERIC SIGNAL ITEM MODIFY EXISTING VEHICLE SIGNALHEAD	4 EA		
WALL ITEMS						
0226	8801000000-E	SP	MSE RETAINING WALL NO **** (W1)	2,300 SF		
0227	8801000000-E	SP	MSE RETAINING WALL NO **** (W2)	7,300 SF		
0228	8847000000-E	SP	GENERIC RETAINING WALL ITEM ARCHITECTURAL CONCRETE SURFACE TREATMENT	7,750 SF		
STRUCTURE ITEMS						
0229	8035000000-N	402	REMOVAL OF EXISTING STRUCTURE AT STATION ***** (22+71.80 -L-)	Lump Sum	L.S.	
0230	8065000000-N	SP	ASBESTOS ASSESSMENT	Lump Sum	L.S.	
0231	8091000000-N	410	FOUNDATION EXCAVATION FOR BENT NO ** AT STATION ***** (22+71.80 -L-)	Lump Sum	L.S.	
0232	8121000000-N	412	UNCLASSIFIED STRUCTURE EXCAVATION AT STATION ***** (22+71.80 -L-)	Lump Sum	L.S.	
0233	8147000000-E	420	REINFORCED CONCRETE DECK SLAB	10,341 SF		

County: WAKE

Line #	Item Number	Sec #	Description	Quantity	Unit Cost	Amount
0234	8161000000-E	420	GROOVING BRIDGE FLOORS	9,425 SF		
0235	8182000000-E	420	CLASS A CONCRETE (BRIDGE)	266.9 CY		
0236	8210000000-N	422	BRIDGE APPROACH SLABS, STATION ***** (22+71.80 -L-)	Lump Sum	L.S.	
0237	8217000000-E	425	REINFORCING STEEL (BRIDGE)	38,558 LB		
0238	8238000000-E	425	SPIRAL COLUMN REINFORCING STEEL (BRIDGE)	2,047 LB		
0239	8265000000-E	430	54" PRESTRESSED CONCRETE GIRDERS	1,247.17 LF		
0240	8328200000-E	450	PILE DRIVING EQUIPMENT SETUP FOR *** STEEL PILES (HP 12 X 53)	46 EA		
0241	8364000000-E	450	HP 12 X 53 STEEL PILES	3,145 LF		
0242	8391000000-N	450	STEEL PILE POINTS	24 EA		
0243	8393000000-N	450	PILE REDRIVES	24 EA		
0244	8394000000-N	450	DYNAMIC PILE TESTING	1 EA		
0245	8531000000-E	462	4" SLOPE PROTECTION	118.2 SY		
0246	8657000000-N	430	ELASTOMERIC BEARINGS	Lump Sum	L.S.	
0247	8860000000-N	SP	GENERIC STRUCTURE ITEM STRIP SEAL EXPANSION JOINTS	Lump Sum	L.S.	
0248	8867000000-E	SP	GENERIC STRUCTURE ITEM CLASSIC CONCRETE BRIDGE RAIL	360.7 LF		

1353/Mar08/Q233910.97/D1203860894000/E248

Total Amount Of Bid For Entire Project :

Vendor 1 of 7: BLYTHE CONSTRUCTION INC (3655)
Call Order 005 (Proposal: C204410)

Bid Information

Proposal County: WAKE	Bid Checksum: 6BDCCE4673
Vendor Address: P.O. Box 31635 CHARLOTTE , NC , 28231	Bid Total: \$11,657,111.76
Signature Check: Brian Webb	Items Total: \$11,657,111.76
Time Bid Received: April 16, 2024 12:18 PM	Time Total: \$0.00
Amendment Count: 0	

Bidding Errors:
None.

Vendor 1 of 7: BLYTHE CONSTRUCTION INC (3655)
Call Order 005 (Proposal: C204410)

Bid Bond Information

Projects:	Bond Maximum:
Counties:	State of Incorporation:
Bond ID: SNC0410139062	Agency Execution Date: 04/10/2024 08:33:00 PM
Paid by Check: No	Surety Name: Surety2000
Bond Percent: 5%	Bond Agency Name: Liberty Mutual Insurance Company

DBE Load Information

Letting ID: L240416
Letting Date: 04/16/2024
Call Order: 005
Contract ID: C204410
Project: 0070245007024500702450070245
Bid Total: \$11,657,111.76
DBE Goal: 3.00% (\$349,713.35)

Vendor ID: 3655
Vendor Name: Blythe Construction Inc.
DBE Entered: 3.22% (\$375,514.00)

<u>Vendor ID</u>	<u>DBE Name</u>	<u>Is Supplier?</u>	<u>City/State</u>	<u>Goods/Service</u>	<u>Amount</u>
11572	CRUZ BROTHERS CONCRETE, INC.	False	1572 PAYNE ROAD LOT 75 GRAHAM, NC 27253	SubContractor	375,514.00

Letting: L240416
04/16/2024 02:00:00 PM

North Carolina Department of Transportation
3655 - Blythe Construction Inc.

Contract ID: C204410
Call: 005

BondID: SNC0410139062

Surety Registry Agency: Surety2000

Verified?: 1

Surety Agency: Liberty Mutual Insurance Company

Bond Execution Date: 04/10/2024 08:33:00 PM

Line Number	Item Number	Quantity	Unit	Unit Price	Extension Price
Section 0001 ROADWAY ITEMS					
0001	0000100000-N MOBILIZATION	1.000	LS	\$550,000.0000	\$550,000.00
0002	0000400000-N CONSTRUCTION SURVEYING	1.000	LS	\$120,000.0000	\$120,000.00
0003	0043000000-N GRADING	1.000	LS	\$1,455,000.0000	\$1,455,000.00
0004	0050000000-E SUPPLEMENTARY CLEARING & GRUBBING	1.000	ACR	\$10,000.0000	\$10,000.00
0005	0057000000-E UNDERCUT EXCAVATION	400.000	CY	\$18.0000	\$7,200.00
0006	0195000000-E SELECT GRANULAR MATERIAL	400.000	CY	\$61.0000	\$24,400.00
0007	0196000000-E GEOTEXTILE FOR SOIL STABILIZATION	500.000	SY	\$5.5000	\$2,750.00
0008	0199000000-E TEMPORARY SHORING	3900.000	SF	\$200.0000	\$780,000.00
0009	0248000000-N GENERIC GRADING ITEM TYPE 2 BRIDGE APPROACH FILL, STA 22+71.80 -L-	1.000	LS	\$65,000.0000	\$65,000.00
0010	0255000000-E GENERIC GRADING ITEM HAULING AND DISPOSAL OF PETROLEUM CONTAMINATED SOIL.	50.000	TON	\$260.0000	\$13,000.00
0011	0318000000-E FOUNDATION CONDITIONING MATERIAL, MINOR STRUCTURES	621.000	TON	\$50.0000	\$31,050.00
0012	0321000000-E FOUNDATION CONDITIONING GEOTEXTILE	3446.000	SY	\$3.0000	\$10,338.00
0013	0335200000-E 15" DRAINAGE PIPE	1180.000	LF	\$65.0000	\$76,700.00
0014	0335300000-E 18" DRAINAGE PIPE	272.000	LF	\$75.0000	\$20,400.00
0015	0335400000-E 24" DRAINAGE PIPE	552.000	LF	\$90.0000	\$49,680.00
0016	0354000000-E **** RC PIPE CULVERTS, CLASS ***** (18", V)	440.000	LF	\$85.0000	\$37,400.00
0017	0448200000-E 15" RC PIPE CULVERTS, CLASS IV	1768.000	LF	\$75.0000	\$132,600.00
0018	0448300000-E 18" RC PIPE CULVERTS, CLASS IV	160.000	LF	\$95.0000	\$15,200.00
0019	0448400000-E 24" RC PIPE CULVERTS, CLASS IV	64.000	LF	\$115.0000	\$7,360.00
0020	0582000000-E 15" CS PIPE CULVERTS, 0.064" THICK	132.000	LF	\$110.0000	\$14,520.00
0021	0636000000-E *** CS PIPE ELBOWS, ***** THICK (15", 0.064")	8.000	EA	\$500.0000	\$4,000.00
0022	0995000000-E PIPE REMOVAL	1241.000	LF	\$28.0000	\$34,748.00
0023	1099500000-E SHALLOW UNDERCUT	200.000	CY	\$25.0000	\$5,000.00

0024	1099700000-E	400.000 TON	\$39.0000	\$15,600.00
	CLASS IV SUBGRADE STABILIZATION			
0025	1112000000-E	600.000 SY	\$4.0000	\$2,400.00
	GEOTEXTILE FOR SUBGRADE STABILIZATION			
0026	1121000000-E	32.000 TON	\$120.0000	\$3,840.00
	AGGREGATE BASE COURSE			
0027	1220000000-E	150.000 TON	\$47.0000	\$7,050.00
	INCIDENTAL STONE BASE			
0028	1330000000-E	2750.000 SY	\$9.0000	\$24,750.00
	INCIDENTAL MILLING			
0029	1491000000-E	3270.000 TON	\$74.0000	\$241,980.00
	ASPHALT CONC BASE COURSE, TYPE B25.0C			
0030	1503000000-E	2330.000 TON	\$76.0000	\$177,080.00
	ASPHALT CONC INTERMEDIATE COURSE, TYPE I19.0C			
0031	1519000000-E	1680.000 TON	\$80.0000	\$134,400.00
	ASPHALT CONC SURFACE COURSE, TYPE S9.5B			
0032	1523000000-E	1350.000 TON	\$84.0000	\$113,400.00
	ASPHALT CONC SURFACE COURSE, TYPE S9.5C			
0033	1575000000-E	450.000 TON	\$640.0000	\$288,000.00
	ASPHALT BINDER FOR PLANT MIX			
0034	1693000000-E	315.000 TON	\$250.0000	\$78,750.00
	ASPHALT PLANT MIX, PAVEMENT REPAIR			
0035	1891000000-E	78.000 SY	\$118.0000	\$9,204.00
	GENERIC PAVING ITEM 6" CONCRETE TRUCK APRON			
0036	2000000000-N	4.000 EA	\$250.0000	\$1,000.00
	RIGHT-OF-WAY MARKERS			
0037	2020000000-N	14.000 EA	\$250.0000	\$3,500.00
	CONTROL-OF-ACCESS MARKERS			
0038	2022000000-E	369.600 CY	\$35.0000	\$12,936.00
	SUBDRAIN EXCAVATION			
0039	2026000000-E	2200.000 SY	\$10.0000	\$22,000.00
	GEOTEXTILE FOR SUBSURFACE DRAINS			
0040	2036000000-E	369.600 CY	\$75.0000	\$27,720.00
	SUBDRAIN COARSE AGGREGATE			
0041	2044000000-E	2200.000 LF	\$16.0000	\$35,200.00
	6" PERFORATED SUBDRAIN PIPE			
0042	2070000000-N	5.000 EA	\$400.0000	\$2,000.00
	SUBDRAIN PIPE OUTLET			
0043	2077000000-E	30.000 LF	\$35.0000	\$1,050.00
	6" OUTLET PIPE			
0044	2275000000-E	5.000 CY	\$460.0000	\$2,300.00
	FLOWABLE FILL			
0045	2286000000-N	49.000 EA	\$3,300.0000	\$161,700.00
	MASONRY DRAINAGE STRUCTURES			
0046	2308000000-E	4.800 LF	\$650.0000	\$3,120.00
	MASONRY DRAINAGE STRUCTURES			
0047	2364000000-N	1.000 EA	\$1,000.0000	\$1,000.00
	FRAME WITH TWO GRATES, STD 840.16			
0048	2364200000-N	4.000 EA	\$1,000.0000	\$4,000.00

FRAME WITH TWO GRATES, STD 840.20				
0049	2365000000-N	5.000 EA	\$1,000.0000	\$5,000.00
FRAME WITH TWO GRATES, STD 840.22				
0050	2366000000-N	9.000 EA	\$1,000.0000	\$9,000.00
FRAME WITH TWO GRATES, STD 840.24				
0051	2374000000-N	3.000 EA	\$1,100.0000	\$3,300.00
FRAME WITH GRATE & HOOD, STD 840.03, TYPE ** (E)				
0052	2374000000-N	10.000 EA	\$1,100.0000	\$11,000.00
FRAME WITH GRATE & HOOD, STD 840.03, TYPE ** (F)				
0053	2374000000-N	14.000 EA	\$1,100.0000	\$15,400.00
FRAME WITH GRATE & HOOD, STD 840.03, TYPE ** (G)				
0054	2396000000-N	6.000 EA	\$1,000.0000	\$6,000.00
FRAME WITH COVER, STD 840.54				
0055	2407000000-N	1.000 EA	\$2,800.0000	\$2,800.00
STEEL FRAME WITH TWO GRATES, STD 840.37				
0056	2542000000-E	170.000 LF	\$21.0000	\$3,570.00
1'-6" CONCRETE CURB & GUTTER				
0057	2549000000-E	4230.000 LF	\$30.2500	\$127,957.50
2'-6" CONCRETE CURB & GUTTER				
0058	2570000000-N	1.000 EA	\$1,900.0000	\$1,900.00
MODIFIED CONCRETE FLUME				
0059	2591000000-E	1630.000 SY	\$55.0000	\$89,650.00
4" CONCRETE SIDEWALK				
0060	2605000000-N	27.000 EA	\$2,500.0000	\$67,500.00
CONCRETE CURB RAMPS				
0061	2612000000-E	310.000 SY	\$91.2500	\$28,287.50
6" CONCRETE DRIVEWAY				
0062	2619000000-E	200.000 SY	\$162.0000	\$32,400.00
4" CONCRETE PAVED DITCH				
0063	2655000000-E	170.000 SY	\$88.5000	\$15,045.00
5" MONOLITHIC CONCRETE ISLANDS (KEYED IN)				
0064	2724000000-E	580.000 LF	\$126.3600	\$73,288.80
PRECAST REINFORCED CONCRETE BARRIER, SINGLE FACED				
0065	2938000000-N	1.000 EA	\$1,167.2100	\$1,167.21
CONVERT EXISTING DROP INLET TO JUNCTION BOX WITH MANHOLE				
0066	3001000000-N	2.000 EA	\$28,460.0000	\$56,920.00
IMPACT ATTENUATOR UNITS, TYPE TL-3				
0067	3030000000-E	300.000 LF	\$23.0000	\$6,900.00
STEEL BEAM GUARDRAIL				
0068	3045000000-E	25.000 LF	\$24.0000	\$600.00
STEEL BEAM GUARDRAIL, SHOP CURVED				
0069	3105000000-N	2.000 EA	\$90.0000	\$180.00
STEEL BEAM GUARDRAIL TERMINAL SECTIONS (TES)				
0070	3215000000-N	2.000 EA	\$2,350.0000	\$4,700.00
GUARDRAIL ANCHOR UNITS, TYPE III				
0071	3288000000-N	2.000 EA	\$3,250.0000	\$6,500.00
GUARDRAIL END UNITS, TYPE TL-2				
0072	3317000000-N	4.000 EA	\$2,600.0000	\$10,400.00
GUARDRAIL ANCHOR UNITS, TYPE B-77				

0073	3500000000-E	370.000 LF	\$7.0000	\$2,590.00
	WOVEN WIRE FENCE, **" FABRIC (48")			
0074	3506000000-E	27.000 EA	\$55.0000	\$1,485.00
	4" TIMBER FENCE POSTS, ***** LONG (48")			
0075	3649000000-E	30.000 TON	\$60.0000	\$1,800.00
	RIP RAP, CLASS B			
0076	3656000000-E	620.000 SY	\$4.0000	\$2,480.00
	GEOTEXTILE FOR DRAINAGE			
0077	4054000000-E	1.000 CY	\$10.0000	\$10.00
	PLAIN CONCRETE SIGN FOUNDATIONS			
0078	4060000000-E	449.000 LB	\$22.0000	\$9,878.00
	SUPPORTS, BREAKAWAY STEEL BEAM			
0079	4072000000-E	860.000 LF	\$15.0000	\$12,900.00
	SUPPORTS, 3-LB STEEL U-CHANNEL			
0080	4096000000-N	6.000 EA	\$200.0000	\$1,200.00
	SIGN ERECTION, TYPE D			
0081	4102000000-N	25.000 EA	\$100.0000	\$2,500.00
	SIGN ERECTION, TYPE E			
0082	4108000000-N	10.000 EA	\$200.0000	\$2,000.00
	SIGN ERECTION, TYPE F			
0083	4110000000-N	3.000 EA	\$750.0000	\$2,250.00
	SIGN ERECTION, TYPE *** (GROUND MOUNTED) (B)			
0084	4116100000-N	1.000 EA	\$300.0000	\$300.00
	SIGN ERECTION, RELOCATE TYPE **** (GROUND MOUNTED) (D)			
0085	4155000000-N	51.000 EA	\$1.0000	\$51.00
	DISPOSAL OF SIGN SYSTEM, U-CHANNEL			
0086	4400000000-E	1011.000 SF	\$12.0000	\$12,132.00
	WORK ZONE SIGNS (STATIONARY)			
0087	4405000000-E	172.000 SF	\$10.0000	\$1,720.00
	WORK ZONE SIGNS (PORTABLE)			
0088	4410000000-E	95.000 SF	\$7.0000	\$665.00
	WORK ZONE SIGNS (BARRICADE MOUNTED)			
0089	4415000000-N	2.000 EA	\$4,995.0000	\$9,990.00
	FLASHING ARROW BOARD			
0090	4420000000-N	4.000 EA	\$18,950.0000	\$75,800.00
	PORTABLE CHANGEABLE MESSAGE SIGN			
0091	4430000000-N	120.000 EA	\$45.0000	\$5,400.00
	DRUMS			
0092	4435000000-N	60.000 EA	\$27.0000	\$1,620.00
	CONES			
0093	4445000000-E	264.000 LF	\$25.0000	\$6,600.00
	BARRICADES (TYPE III)			
0094	4455000000-N	360.000 DAY	\$274.0000	\$98,640.00
	FLAGGER			
0095	4465000000-N	4.000 EA	\$9,250.0000	\$37,000.00
	TEMPORARY CRASH CUSHIONS			
0096	4480000000-N	2.000 EA	\$6,800.0000	\$13,600.00
	TMA			
0097	4485000000-E	1530.000 LF	\$41.6500	\$63,724.50

PORTABLE CONCRETE BARRIER

0098	4490000000-E	950.000 LF	\$62.9000	\$59,755.00
	PORTABLE CONCRETE BARRIER (ANCHORED)			
0099	4505000000-E	520.000 LF	\$27.6500	\$14,378.00
	REMOVE & RESET PORTABLE CONCRETE BARRIER (ANCHORED)			
0100	4510000000-N	160.000 HR	\$65.0000	\$10,400.00
	LAW ENFORCEMENT			
0101	4516000000-N	40.000 EA	\$36.0000	\$1,440.00
	SKINNY DRUM			
0102	4650000000-N	115.000 EA	\$8.0000	\$920.00
	TEMPORARY RAISED PAVEMENT MARKERS			
0103	4695000000-E	832.000 LF	\$3.0000	\$2,496.00
	THERMOPLASTIC PAVEMENT MARKING LINES (8", 90 MILS)			
0104	4709000000-E	200.000 LF	\$15.0000	\$3,000.00
	THERMOPLASTIC PAVEMENT MARKING LINES (24", 90 MILS)			
0105	4720000000-E	4.000 EA	\$125.0000	\$500.00
	THERMOPLASTIC PAVEMENT MARKING CHARACTER (90 MILS)			
0106	4725000000-E	19.000 EA	\$150.0000	\$2,850.00
	THERMOPLASTIC PAVEMENT MARKING SYMBOL (90 MILS)			
0107	4770000000-E	555.000 LF	\$3.0000	\$1,665.00
	COLD APPLIED PLASTIC PAVEMENT MARKING LINES, TYPE ** (4") (IV)			
0108	4810000000-E	29917.000 LF	\$0.6000	\$17,950.20
	PAINT PAVEMENT MARKING LINES (4")			
0109	4820000000-E	156.000 LF	\$1.0000	\$156.00
	PAINT PAVEMENT MARKING LINES (8")			
0110	4835000000-E	80.000 LF	\$10.0000	\$800.00
	PAINT PAVEMENT MARKING LINES (24")			
0111	4845000000-N	3.000 EA	\$100.0000	\$300.00
	PAINT PAVEMENT MARKING SYMBOL			
0112	4846000000-E	9894.000 LF	\$2.1000	\$20,777.40
	POLYUREA PAVEMENT MARKING LINES (**", ** MILS) (4", 20 MILS)			
0113	4846000000-E	472.000 LF	\$2.2000	\$1,038.40
	POLYUREA PAVEMENT MARKING LINES (**", ** MILS) (4", 30 MILS)			
0114	4846000000-E	72.000 LF	\$2.5000	\$180.00
	POLYUREA PAVEMENT MARKING LINES (**", ** MILS) (6", 20 MILS)			
0115	4846000000-E	159.000 LF	\$2.7500	\$437.25
	POLYUREA PAVEMENT MARKING LINES (**", ** MILS) (8", 20 MILS)			
0116	4850000000-E	6651.000 LF	\$1.5000	\$9,976.50
	REMOVAL OF PAVEMENT MARKING LINES (4")			
0117	4900000000-N	4.000 EA	\$8.0000	\$32.00
	PERMANENT RAISED PAVEMENT MARKERS			
0118	4905100000-N	157.000 EA	\$75.0000	\$11,775.00
	NON-CAST IRON SNOWPLOWABLE PAVEMENT MARKER			
0119	5150000000-E	350.000 LF	\$32.0000	\$11,200.00
	ELECTRICAL DUCT, TYPE **, SIZE ***** (JA, 2")			
0120	5155000000-E	3750.000 LF	\$13.5000	\$50,625.00
	ELECTRICAL DUCT, TYPE BD, SIZE ***** (2")			
0121	5240000000-N	2.000 EA	\$1,250.0000	\$2,500.00
	ELECTRICAL JUNCTION BOXES ***** (IG18)			

0122	5240000000-N	4.000 EA	\$2,250.0000	\$9,000.00
	ELECTRICAL JUNCTION BOXES ***** (IG30)			
0123	5255000000-N	1.000 LS	\$50,000.0000	\$50,000.00
	PORTABLE LIGHTING			
0124	5260000000-N	1.000 LS	\$90,000.0000	\$90,000.00
	GENERIC LIGHTING ITEM ELECTRICAL CONDUIT SYSTEM AT STATION 22+71.80-L-			
0125	5319000000-E	3.000 CY	\$322.0000	\$966.00
	CLASS B CONCRETE FOR ENCASING UTILITY LINES			
0126	5325600000-E	190.000 LF	\$251.0000	\$47,690.00
	6" WATER LINE			
0127	5325800000-E	568.000 LF	\$239.0000	\$135,752.00
	8" WATER LINE			
0128	5326000000-E	1706.000 LF	\$207.0000	\$353,142.00
	10" WATER LINE			
0129	5329000000-E	6815.000 LB	\$12.0000	\$81,780.00
	DUCTILE IRON WATER PIPE FITTINGS			
0130	5540000000-E	6.000 EA	\$5,300.0000	\$31,800.00
	6" VALVE			
0131	5546000000-E	3.000 EA	\$5,350.0000	\$16,050.00
	8" VALVE			
0132	5552000000-E	7.000 EA	\$8,100.0000	\$56,700.00
	10" VALVE			
0133	5562000000-E	1.000 EA	\$34,300.0000	\$34,300.00
	**" INSERTION VALVE (10")			
0134	5562000000-E	2.000 EA	\$18,275.0000	\$36,550.00
	**" INSERTION VALVE (6")			
0135	5562000000-E	3.000 EA	\$21,200.0000	\$63,600.00
	**" INSERTION VALVE (8")			
0136	5648000000-N	14.000 EA	\$1,850.0000	\$25,900.00
	RELOCATE WATER METER			
0137	5666000000-N	3.000 EA	\$12,425.0000	\$37,275.00
	FIRE HYDRANT			
0138	5672000000-N	2.000 EA	\$5,760.0000	\$11,520.00
	RELOCATE FIRE HYDRANT			
0139	5673000000-E	62.000 LF	\$315.0000	\$19,530.00
	FIRE HYDRANT LEG			
0140	5686000000-E	363.000 LF	\$121.0000	\$43,923.00
	**" WATER SERVICE LINE (1")			
0141	5768000000-N	1.000 EA	\$2,680.0000	\$2,680.00
	SANITARY SEWER CLEAN-OUT			
0142	5768500000-E	10.000 LF	\$405.0000	\$4,050.00
	SEWER SERVICE LINE			
0143	5769000000-E	45.000 LB	\$26.0000	\$1,170.00
	DUCTILE IRON SEWER PIPE FITTINGS			
0144	5777000000-E	1.000 EA	\$18,400.0000	\$18,400.00
	6' DIA UTILITY MANHOLE			
0145	5783000000-E	3.000 LF	\$1,450.0000	\$4,350.00
	UTILITY MANHOLE WALL 6' DIA			
0146	5800000000-E	50.000 LF	\$9.0000	\$450.00

ABANDON 6" UTILITY PIPE					
0147	5801000000-E	871.000	LF	\$13.0000	\$11,323.00
ABANDON 8" UTILITY PIPE					
0148	5802000000-E	1622.000	LF	\$17.0000	\$27,574.00
ABANDON 10" UTILITY PIPE					
0149	5815000000-N	4.000	EA	\$670.0000	\$2,680.00
REMOVE WATER METER					
0150	5828000000-N	3.000	EA	\$2,260.0000	\$6,780.00
REMOVE UTILITY MANHOLE					
0151	5835700000-E	20.000	LF	\$430.0000	\$8,600.00
16" ENCASEMENT PIPE					
0152	5835900000-E	164.000	LF	\$225.0000	\$36,900.00
20" ENCASEMENT PIPE					
0153	5872500000-E	164.000	LF	\$721.0000	\$118,244.00
BORE AND JACK OF *** (20")					
0154	6000000000-E	4820.000	LF	\$3.0000	\$14,460.00
TEMPORARY SILT FENCE					
0155	6006000000-E	630.000	TON	\$64.0000	\$40,320.00
STONE FOR EROSION CONTROL, CLASS A					
0156	6009000000-E	335.000	TON	\$62.0000	\$20,770.00
STONE FOR EROSION CONTROL, CLASS B					
0157	6012000000-E	775.000	TON	\$51.0000	\$39,525.00
SEDIMENT CONTROL STONE					
0158	6015000000-E	9.000	ACR	\$1,600.0000	\$14,400.00
TEMPORARY MULCHING					
0159	6018000000-E	600.000	LB	\$5.0000	\$3,000.00
SEED FOR TEMPORARY SEEDING					
0160	6021000000-E	4.000	TON	\$1,000.0000	\$4,000.00
FERTILIZER FOR TEMPORARY SEEDING					
0161	6024000000-E	200.000	LF	\$21.0000	\$4,200.00
TEMPORARY SLOPE DRAINS					
0162	6029000000-E	440.000	LF	\$2.0000	\$880.00
SAFETY FENCE					
0163	6030000000-E	1040.000	CY	\$9.0000	\$9,360.00
SILT EXCAVATION					
0164	6036000000-E	11700.000	SY	\$2.0000	\$23,400.00
MATTING FOR EROSION CONTROL					
0165	6037000000-E	100.000	SY	\$5.0000	\$500.00
COIR FIBER MAT					
0166	6042000000-E	1160.000	LF	\$0.3000	\$348.00
1/4" HARDWARE CLOTH					
0167	6043000000-E	100.000	SY	\$7.0000	\$700.00
LOW PERMEABILITY GEOTEXTILE					
0168	6070000000-N	1.000	EA	\$800.0000	\$800.00
SPECIAL STILLING BASINS					
0169	6071002000-E	220.000	LB	\$8.0000	\$1,760.00
FLOCCULANT					
0170	6071012000-E	650.000	LF	\$13.0000	\$8,450.00
COIR FIBER WATTLE					

0171	6071030000-E COIR FIBER BAFFLE	75.000 LF	\$7.0000	\$525.00
0172	6071050000-E *** SKIMMER (1-1/2")	1.000 EA	\$1,800.0000	\$1,800.00
0173	6084000000-E SEEDING & MULCHING	9.000 ACR	\$2,600.0000	\$23,400.00
0174	6087000000-E MOWING	4.500 ACR	\$175.0000	\$787.50
0175	6090000000-E SEED FOR REPAIR SEEDING	100.000 LB	\$7.0000	\$700.00
0176	6093000000-E FERTILIZER FOR REPAIR SEEDING	0.250 TON	\$1,175.0000	\$293.75
0177	6096000000-E SEED FOR SUPPLEMENTAL SEEDING	175.000 LB	\$7.0000	\$1,225.00
0178	6108000000-E FERTILIZER TOPDRESSING	5.250 TON	\$1,175.0000	\$6,168.75
0179	6114500000-N SPECIALIZED HAND MOWING	10.000 MHR	\$45.0000	\$450.00
0180	6114800000-N MANUAL LITTER REMOVAL	4.000 MHR	\$145.0000	\$580.00
0181	6114900000-E LITTER DISPOSAL	1.000 TON	\$750.0000	\$750.00
0182	6117000000-N RESPONSE FOR EROSION CONTROL	18.000 EA	\$300.0000	\$5,400.00
0183	6117500000-N CONCRETE WASHOUT STRUCTURE	2.000 EA	\$1,000.0000	\$2,000.00
0184	6132000000-N GENERIC EROSION CONTROL ITEM FABRIC INSERT INLET PROTECTION - (TYPE 2)	3.000 EA	\$100.0000	\$300.00
0185	6132000000-N GENERIC EROSION CONTROL ITEM FABRIC INSERT INLET PROTECTION CLEANOUT	6.000 EA	\$300.0000	\$1,800.00
0186	7048500000-E PEDESTRIAN SIGNAL HEAD (16", 1 SECTION W/COUNTDOWN)	10.000 EA	\$1,340.0000	\$13,400.00
0187	7060000000-E SIGNAL CABLE	3510.000 LF	\$4.0000	\$14,040.00
0188	7120000000-E VEHICLE SIGNAL HEAD (12", 3 SECTION)	22.000 EA	\$1,150.0000	\$25,300.00
0189	7132000000-E VEHICLE SIGNAL HEAD (12", 4 SECTION)	1.000 EA	\$1,300.0000	\$1,300.00
0190	7264000000-E MESSENGER CABLE (3/8")	500.000 LF	\$10.0000	\$5,000.00
0191	7288000000-E PAVED TRENCHING (***** (1, 2"))	25.000 LF	\$55.0000	\$1,375.00
0192	7300000000-E UNPAVED TRENCHING (***** (1, 2"))	760.000 LF	\$13.5000	\$10,260.00
0193	7300000000-E UNPAVED TRENCHING (***** (2, 2"))	150.000 LF	\$20.0000	\$3,000.00
0194	7300000000-E UNPAVED TRENCHING (***** (3, 2"))	50.000 LF	\$30.0000	\$1,500.00
0195	7301000000-E	1425.000 LF	\$42.0000	\$59,850.00

DIRECTIONAL DRILL (*****) (2, 2")

0196	7324000000-N	11.000 EA	\$625.0000	\$6,875.00
	JUNCTION BOX (STANDARD SIZE)			
0197	7348000000-N	8.000 EA	\$1,275.0000	\$10,200.00
	JUNCTION BOX (OVER-SIZED, HEAVY DUTY)			
0198	7360000000-N	4.000 EA	\$1,350.0000	\$5,400.00
	WOOD POLE			
0199	7372000000-N	16.000 EA	\$800.0000	\$12,800.00
	GUY ASSEMBLY			
0200	7408000000-E	1.000 EA	\$500.0000	\$500.00
	1" RISER WITH WEATHERHEAD			
0201	7420000000-E	3.000 EA	\$1,000.0000	\$3,000.00
	2" RISER WITH WEATHERHEAD			
0202	7432000000-E	1.000 EA	\$1,500.0000	\$1,500.00
	2" RISER WITH HEAT SHRINK TUBING			
0203	7444000000-E	1100.000 LF	\$12.5000	\$13,750.00
	INDUCTIVE LOOP SAWCUT			
0204	7456100000-E	3350.000 LF	\$2.0000	\$6,700.00
	LEAD-IN CABLE (14-2)			
0205	7516000000-E	260.000 LF	\$5.0000	\$1,300.00
	COMMUNICATIONS CABLE (** FIBER) (12)			
0206	7516000000-E	700.000 LF	\$4.5000	\$3,150.00
	COMMUNICATIONS CABLE (** FIBER) (24)			
0207	7528000000-E	200.000 LF	\$4.5000	\$900.00
	DROP CABLE			
0208	7540000000-N	1.000 EA	\$1,950.0000	\$1,950.00
	SPLICE ENCLOSURE			
0209	7541000000-N	1.000 EA	\$1,400.0000	\$1,400.00
	MODIFY SPLICE ENCLOSURE			
0210	7552000000-N	1.000 EA	\$2,500.0000	\$2,500.00
	INTERCONNECT CENTER			
0211	7566000000-N	1.000 EA	\$200.0000	\$200.00
	DELINEATOR MARKER			
0212	7588000000-N	6.000 EA	\$22,220.0000	\$133,320.00
	METAL POLE WITH SINGLE MAST ARM			
0213	7613000000-N	6.000 EA	\$1,350.0000	\$8,100.00
	SOIL TEST			
0214	7614100000-E	36.000 CY	\$1,500.0000	\$54,000.00
	DRILLED PIER FOUNDATION			
0215	7631000000-N	6.000 EA	\$25.0000	\$150.00
	MAST ARM WITH METAL POLE DESIGN			
0216	7636000000-N	4.000 EA	\$325.0000	\$1,300.00
	SIGN FOR SIGNALS			
0217	7642100000-N	3.000 EA	\$2,600.0000	\$7,800.00
	TYPE I POST WITH FOUNDATION			
0218	7642200000-N	5.000 EA	\$3,200.0000	\$16,000.00
	TYPE II PEDESTAL WITH FOUNDATION			
0219	7684000000-N	2.000 EA	\$3,200.0000	\$6,400.00
	SIGNAL CABINET FOUNDATION			

0220	7696000000-N	2.000 EA	\$26,500.0000	\$53,000.00
CONTROLLERS WITH CABINET (***** (TYPE 2070LX, BASE MOUNTED)				
0221	7744000000-N	8.000 EA	\$275.0000	\$2,200.00
DETECTOR CARD (TYPE 170)				
0222	7901000000-N	2.000 EA	\$800.0000	\$1,600.00
CABINET BASE EXTENDER				
0223	7980000000-N	1.000 EA	\$4,500.0000	\$4,500.00
GENERIC SIGNAL ITEM ETHERNET EDGE SWITCH				
0224	7980000000-N	1.000 EA	\$37,500.0000	\$37,500.00
GENERIC SIGNAL ITEM MICROWAVE VEHICLE DETECTION SYSTEM - MULTIPLE ZONES				
0225	7980000000-N	4.000 EA	\$150.0000	\$600.00
GENERIC SIGNAL ITEM MODIFY EXISTING VEHICLE SIGNALHEAD				

Section 0001 Total \$8,166,631.26

Section 0003
 WALL ITEMS

0226	8801000000-E	2300.000 SF	\$150.0000	\$345,000.00
MSE RETAINING WALL NO **** (W1)				
0227	8801000000-E	7300.000 SF	\$100.0000	\$730,000.00
MSE RETAINING WALL NO **** (W2)				
0228	8847000000-E	7750.000 SF	\$12.0000	\$93,000.00
GENERIC RETAINING WALL ITEM ARCHITECTURAL CONCRETE SURFACE TREATMENT				

Section 0003 Total \$1,168,000.00

Section 0004
 STRUCTURE ITEMS

0229	8035000000-N	1.000 LS	\$150,000.0000	\$150,000.00
REMOVAL OF EXISTING STRUCTURE AT STATION ***** (22+71.80 -L-)				
0230	8065000000-N	1.000 LS	\$1,400.0000	\$1,400.00
ASBESTOS ASSESSMENT				
0231	8091000000-N	1.000 LS	\$2,500.0000	\$2,500.00
FOUNDATION EXCAVATION FOR BENT NO ** AT STATION ***** (22+71.80 -L-)				
0232	8121000000-N	1.000 LS	\$35,000.0000	\$35,000.00
UNCLASSIFIED STRUCTURE EXCAVATION AT STATION ***** (22+71.80 -L-)				
0233	8147000000-E	10341.000 SF	\$60.0000	\$620,460.00
REINFORCED CONCRETE DECK SLAB				
0234	8161000000-E	9425.000 SF	\$1.5000	\$14,137.50
GROOVING BRIDGE FLOORS				
0235	8182000000-E	266.900 CY	\$1,200.0000	\$320,280.00
CLASS A CONCRETE (BRIDGE)				
0236	8210000000-N	1.000 LS	\$120,000.0000	\$120,000.00
BRIDGE APPROACH SLABS, STATION ***** (22+71.80 -L-)				
0237	8217000000-E	38558.000 LB	\$2.0000	\$77,116.00
REINFORCING STEEL (BRIDGE)				
0238	8238000000-E	2047.000 LB	\$3.0000	\$6,141.00
SPIRAL COLUMN REINFORCING STEEL (BRIDGE)				

0239	8265000000-E	1247.170	LF	\$400.0000	\$498,868.00
	54" PRESTRESSED CONCRETE GIRDERS				
0240	8328200000-E	46.000	EA	\$650.0000	\$29,900.00
	PILE DRIVING EQUIPMENT SETUP FOR *** STEEL PILES (HP 12 X 53)				
0241	8364000000-E	3145.000	LF	\$50.0000	\$157,250.00
	HP 12 X 53 STEEL PILES				
0242	8391000000-N	24.000	EA	\$150.0000	\$3,600.00
	STEEL PILE POINTS				
0243	8393000000-N	24.000	EA	\$500.0000	\$12,000.00
	PILE REDRIVES				
0244	8394000000-N	1.000	EA	\$3,000.0000	\$3,000.00
	DYNAMIC PILE TESTING				
0245	8531000000-E	118.200	SY	\$140.0000	\$16,548.00
	4" SLOPE PROTECTION				
0246	8657000000-N	1.000	LS	\$10,000.0000	\$10,000.00
	ELASTOMERIC BEARINGS				
0247	8860000000-N	1.000	LS	\$100,000.0000	\$100,000.00
	GENERIC STRUCTURE ITEM STRIP SEAL EXPANSION JOINTS				
0248	8867000000-E	360.700	LF	\$400.0000	\$144,280.00
	GENERIC STRUCTURE ITEM CLASSIC CONCRETE BRIDGE RAIL				
Section 0004 Total					\$2,322,480.50
Item Total					\$11,657,111.76

ELECTRONIC BID SUBMISSION

By submitting this bid electronically, I hereby acknowledge that all requirements included in the hard copy proposal, addendum, amendments, plans, standard specifications, supplemental specifications and special provisions are part of the bid and contract. Further, I acknowledge that I have read, understand, accept, acknowledge and agree to comply with all statements in this electronic bid.

=====

NON-COLLUSION, DEBARMENT AND GIFT BAN CERTIFICATION

The prequalified bidder declares (or certifies, verifies, or states) under penalty of perjury under the laws of the United States that neither he, nor any official, agent or employee has entered into any agreement, participated in any collusion, or otherwise taken any action which is in restraint of free competitive bidding in connection with any bid or contract, that the prequalified bidder has not been convicted of violating N.C.G.S. §133-24 within the last three years, and that the prequalified bidder intends to do the work with his own bonafide employees or subcontractors and will not bid for the benefit of another contractor.

By submitting this non-collusion, debarment and gift ban certification, the Contractor is attesting his status under penalty of perjury under the laws of the United States in accordance with the Debarment Certification attached, provided that the Debarment Certification also includes any required statements concerning exceptions that are applicable.

N.C.G.S. §133-32 and Executive Order 24 prohibit the offer to, or acceptance by, any State Employee of any gift from anyone with a contract with the State, or from any person seeking to do business with the State. By execution of any response in this procurement, you attest, for your entire organization and its employees or agents, that you are not aware that any such gift has been offered, accepted, or promised by any employees of your organization.

DEBARMENT CERTIFICATION OF PREQUALIFIED BIDDER

Conditions for certification:

1. The prequalified bidder shall provide immediate written notice to the Department if at any time the bidder learns that his certification was erroneous when he submitted his debarment certification or explanation that is file with the Department, or has become erroneous because of changed circumstances.
2. The terms covered transaction, debarred, suspended, ineligible, lower tier

covered transaction, participant, person, primary covered transaction, principal, proposal, and voluntarily excluded, as used in this provision, have the meanings set out in the Definitions and Coverage sections of the rules implementing Executive Order 12549. A copy of the Federal Rules requiring this certification and detailing the definitions and coverages may be obtained from the Contract Officer of the Department.

3. The prequalified bidder agrees by submitting this form, that he will not knowingly enter into any lower tier covered transaction with a person who is debarred, suspended, declared ineligible, or voluntarily excluded from participation in NCDOT contracts, unless authorized by the Department.

4. For Federal Aid projects, the prequalified bidder further agrees that by submitting this form he will include the Federal- Aid Provision titled Required Contract Provisions Federal-Aid Construction Contract (Form FHWA PR 1273) provided by the Department, without subsequent modification, in all lower tier covered transactions.

5. The prequalified bidder may rely upon a certification of a participant in a lower tier covered transaction that he is not debarred, suspended, ineligible, or voluntarily excluded from the covered transaction, unless he knows that the certification is erroneous. The bidder may decide the method and frequency by which he will determine the eligibility of his subcontractors.

6. Nothing contained in the foregoing shall be construed to require establishment of a system of records in order to render in good faith the certification required by this provision. The knowledge and information of a participant is not required to exceed that which is normally possessed by a prudent person in the ordinary course of business dealings.

7. Except as authorized in paragraph 6 herein, the Department may terminate any contract if the bidder knowingly enters into a lower tier covered transaction with a person who is suspended, debarred, ineligible, or voluntarily excluded from participation in this transaction, in addition to other remedies available by the Federal Government.

DEBARMENT CERTIFICATION

The prequalified bidder certifies to the best of his knowledge and belief, that he and his principals:

a. Are not presently debarred, suspended, proposed for debarment, declared ineligible, or voluntarily excluded from covered transactions by any Federal department or agency;

b. Have not within a three-year period preceding this proposal been convicted of or had a civil judgment rendered against them for commission of fraud or a criminal offense in connection with obtaining, attempting to obtain, or performing a public (Federal, State or local) transaction or contract under a public transaction; violation of Federal or State antitrust statutes or

commission of embezzlement, theft, forgery, bribery, falsification or destruction of records; making false statements; or receiving stolen property;

c. Are not presently indicted for or otherwise criminally or civilly charged by a governmental entity (Federal, State or local) with commission of any of the offenses enumerated in paragraph b. of this certification; and

d. Have not within a three-year period preceding this proposal had one or more public transactions (Federal, State or local) terminated for cause or default.

e. Will submit a revised Debarment Certification immediately if his status changes and will show in his bid proposal an explanation for the change in status.

If the prequalified bidder cannot certify that he is not debarred, he shall provide an explanation with this submittal. An explanation will not necessarily result in denial of participation in a contract.

Failure to submit a non-collusion and debarment certification will result in the prequalified bidder's bid being considered non-responsive.

EXPLANATION:

=====

Award Limits on Multiple Projects

By answering YES to this statement, the bidder acknowledges that they are using the award limits on multiple projects? **Yes** **No**

A bidder who desires to bid on more than one project on which bids are to be opened on the same date, and who also desires to avoid receiving an award of more projects than he is equipped to handle, may bid on any number of projects but may limit the total amount of work awarded to him on selected projects by completing the AWARD LIMITS ON MULTIPLE PROJECTS.

The Award Limits on Multiple Projects must be filled in on each project bid for which the Bidder desires protection.

It is the desire of the Bidder to be awarded contracts, the value of which will not exceed a total of for those projects indicated herein, for which bids will be opened on (MM/DD/YY)

The Award Limits shall apply to the following projects:

Contract Number
County

Contract Number
County

Contract Number
County

Contract Number
County

Contract Number
County

Contract Number
County

It is agreed that if I am (we are) the low Bidder(s) on indicated projects, the total value of which is more than the above stipulated award limits, the Board of Transportation will award me (us) projects from among those indicated

that have a total value not to exceed the award limit and will result in the lowest total bids to the Department of Transportation.

DBE List Summary

Project: 0070245

Bidder ID: 3655

Bid Total: 11,657,111.76

Business Name: Blythe Construction Inc.

Goal: 3.00% (349,713.35)

Total Entered: 3.22% (375,514.00)

<u>ID</u>	<u>Name</u>	<u>Is Supplier?</u>	<u>Item Count</u>	<u>Amount</u>	<u>Is Complete?</u>
11572	CRUZ BROTHERS CONCRETE, INC.	False	9	375,514.00	True

Name: CRUZ BROTHERS CONCRETE, INC. ID: 11572

Address: 1572 PAYNE ROAD LOT 75 GRAHAM, NC 27253

Used As: SubContractor DBE Items Total:\$375,514.00

Items for CRUZ BROTHERS CONCRETE, INC.

0001				
ROADWAY ITEMS				
0035	1891000000-E	78.000 SY	\$118.0000	\$9,204.00
	GENERIC PAVING ITEM 6" CONCRETE TRUCK APRON			
0056	2542000000-E	170.000 LF	\$21.0000	\$3,570.00
	1'-6" CONCRETE CURB & GUTTER			
0057	2549000000-E	4230.000 LF	\$30.2500	\$127,957.50
	2'-6" CONCRETE CURB & GUTTER			
0058	2570000000-N	1.000 EA	\$1,900.0000	\$1,900.00
	MODIFIED CONCRETE FLUME			
0059	2591000000-E	1630.000 SY	\$55.0000	\$89,650.00
	4" CONCRETE SIDEWALK			
0060	2605000000-N	27.000 EA	\$2,500.0000	\$67,500.00
	CONCRETE CURB RAMPS			
0061	2612000000-E	310.000 SY	\$91.2500	\$28,287.50
	6" CONCRETE DRIVEWAY			
0062	2619000000-E	200.000 SY	\$162.0000	\$32,400.00
	4" CONCRETE PAVED DITCH			
0063	2655000000-E	170.000 SY	\$88.5000	\$15,045.00
	5" MONOLITHIC CONCRETE ISLANDS (KEYED IN)			
Section 0001 Total				\$375,514.00
Item Total				\$375,514.00

THIS PROPOSAL CONTAINS THE FOLLOWING ERRORS/WARNINGS (IF ANY)

This Bid contains 0 amendment files

Electronic Bid Submission

By submitting this bid electronically, I hereby acknowledge that all requirements included in the hard copy proposal, addendum, amendments, plans, standard specifications, supplemental specifications and special provisions are part of the bid and contract. Further, I acknowledge that I have read, understand, accept, acknowledge and agree to comply with all statements in this electronic bid.

I hereby certify that I have the authority to submit this bid.

Signature _____

Agency _____

Date _____

Signature _____

Agency _____

Date _____

Signature _____

Agency _____

Date _____

Attachments

Failure to complete and attach the Fuel Usage Factor Adjustment Form will result in using 2.90 gallons per ton as the Fuel Usage Factor for Diesel for the asphalt items included on the form. The contractor will not be permitted to change the option after the bids are submitted.

NOTE: The maximum upload limit is 5 MB.

Verify

Line #	ItemNumber	Sec #	Description	Quantity Unit	Unit Bid Price	Amount Bid
ROADWAY ITEMS						
0001	0000100000-N	800	MOBILIZATION	LUMP SUM	550,000.00	550,000.00
0002	0000400000-N	801	CONSTRUCTION SURVEYING	LUMP SUM	120,000.00	120,000.00
0003	0043000000-N	226	GRADING	LUMP SUM	1,455,000.00	1,455,000.00
0004	0050000000-E	226	SUPPLEMENTARY CLEARING & GRUBBING	1 ACR	10,000.00	10,000.00
0005	0057000000-E	226	UNDERCUT EXCAVATION	400 CY	18.00	7,200.00
0006	0195000000-E	265	SELECT GRANULAR MATERIAL	400 CY	61.00	24,400.00
0007	0196000000-E	270	GEOTEXTILE FOR SOIL STABILIZATION	500 SY	5.50	2,750.00
0008	0199000000-E	SP	TEMPORARY SHORING	3,900 SF	200.00	780,000.00
0009	0248000000-N	SP	GENERIC GRADING ITEM TYPE 2 BRIDGE APPROACH FILL, STA 22+71.80 -L-	LUMP SUM	65,000.00	65,000.00
0010	0255000000-E	SP	GENERIC GRADING ITEM HAULING AND DISPOSAL OF PETROLEUM CONTAMINATED SOIL.	50 TON	260.00	13,000.00
0011	0318000000-E	300	FOUNDATION CONDITIONING MATERIAL, MINOR STRUCTURES	621 TON	50.00	31,050.00
0012	0321000000-E	300	FOUNDATION CONDITIONING GEOTEXTILE	3,446 SY	3.00	10,338.00
0013	0335200000-E	305	15" DRAINAGE PIPE	1,180 LF	65.00	76,700.00
0014	0335300000-E	305	18" DRAINAGE PIPE	272 LF	75.00	20,400.00
0015	0335400000-E	305	24" DRAINAGE PIPE	552 LF	90.00	49,680.00
0016	0354000000-E	310	**** RC PIPE CULVERTS, CLASS **** (18", V)	440 LF	85.00	37,400.00
0017	0448200000-E	310	15" RC PIPE CULVERTS, CLASS IV	1,768 LF	75.00	132,600.00
0018	0448300000-E	310	18" RC PIPE CULVERTS, CLASS IV	160 LF	95.00	15,200.00
0019	0448400000-E	310	24" RC PIPE CULVERTS, CLASS IV	64 LF	115.00	7,360.00
0020	0582000000-E	310	15" CS PIPE CULVERTS, 0.064" THICK	132 LF	110.00	14,520.00
0021	0636000000-E	310	*** CS PIPE ELBOWS, ***** THICK (15", 0.064")	8 EA	500.00	4,000.00

Line #	ItemNumber	Sec #	Description	Quantity Unit	Unit Bid Price	Amount Bid
0022	0995000000-E	340	PIPE REMOVAL	1,241 LF	28.00	34,748.00
0023	1099500000-E	505	SHALLOW UNDERCUT	200 CY	25.00	5,000.00
0024	1099700000-E	505	CLASS IV SUBGRADE STABILIZATION	400 TON	39.00	15,600.00
0025	1112000000-E	505	GEOTEXTILE FOR SUBGRADE STABILIZATION	600 SY	4.00	2,400.00
0026	1121000000-E	520	AGGREGATE BASE COURSE	32 TON	120.00	3,840.00
0027	1220000000-E	545	INCIDENTAL STONE BASE	150 TON	47.00	7,050.00
0028	1330000000-E	607	INCIDENTAL MILLING	2,750 SY	9.00	24,750.00
0029	1491000000-E	610	ASPHALT CONC BASE COURSE, TYPE B25.0C	3,270 TON	74.00	241,980.00
0030	1503000000-E	610	ASPHALT CONC INTERMEDIATE COURSE, TYPE I19.0C	2,330 TON	76.00	177,080.00
0031	1519000000-E	610	ASPHALT CONC SURFACE COURSE, TYPE S9.5B	1,680 TON	80.00	134,400.00
0032	1523000000-E	610	ASPHALT CONC SURFACE COURSE, TYPE S9.5C	1,350 TON	84.00	113,400.00
0033	1575000000-E	620	ASPHALT BINDER FOR PLANT MIX	450 TON	640.00	288,000.00
0034	1693000000-E	654	ASPHALT PLANT MIX, PAVEMENT REPAIR	315 TON	250.00	78,750.00
0035	1891000000-E	SP	GENERIC PAVING ITEM 6" CONCRETE TRUCK APRON	78 SY	118.00	9,204.00
0036	2000000000-N	806	RIGHT-OF-WAY MARKERS	4 EA	250.00	1,000.00
0037	2020000000-N	806	CONTROL-OF-ACCESS MARKERS	14 EA	250.00	3,500.00
0038	2022000000-E	815	SUBDRAIN EXCAVATION	369.6 CY	35.00	12,936.00
0039	2026000000-E	815	GEOTEXTILE FOR SUBSURFACE DRAINS	2,200 SY	10.00	22,000.00
0040	2036000000-E	815	SUBDRAIN COARSE AGGREGATE	369.6 CY	75.00	27,720.00
0041	2044000000-E	815	6" PERFORATED SUBDRAIN PIPE	2,200 LF	16.00	35,200.00
0042	2070000000-N	815	SUBDRAIN PIPE OUTLET	5 EA	400.00	2,000.00
0043	2077000000-E	815	6" OUTLET PIPE	30 LF	35.00	1,050.00
0044	2275000000-E	SP	FLOWABLE FILL	5 CY	460.00	2,300.00

Line #	ItemNumber	Sec #	Description	Quantity Unit	Unit Bid Price	Amount Bid
0045	2286000000-N	840	MASONRY DRAINAGE STRUCTURES	49 EA	3,300.00	161,700.00
0046	2308000000-E	840	MASONRY DRAINAGE STRUCTURES	4.8 LF	650.00	3,120.00
0047	2364000000-N	840	FRAME WITH TWO GRATES, STD 840.16	1 EA	1,000.00	1,000.00
0048	2364200000-N	840	FRAME WITH TWO GRATES, STD 840.20	4 EA	1,000.00	4,000.00
0049	2365000000-N	840	FRAME WITH TWO GRATES, STD 840.22	5 EA	1,000.00	5,000.00
0050	2366000000-N	840	FRAME WITH TWO GRATES, STD 840.24	9 EA	1,000.00	9,000.00
0051	2374000000-N	840	FRAME WITH GRATE & HOOD, STD 840.03, TYPE ** (E)	3 EA	1,100.00	3,300.00
0052	2374000000-N	840	FRAME WITH GRATE & HOOD, STD 840.03, TYPE ** (F)	10 EA	1,100.00	11,000.00
0053	2374000000-N	840	FRAME WITH GRATE & HOOD, STD 840.03, TYPE ** (G)	14 EA	1,100.00	15,400.00
0054	2396000000-N	840	FRAME WITH COVER, STD 840.54	6 EA	1,000.00	6,000.00
0055	2407000000-N	840	STEEL FRAME WITH TWO GRATES, STD 840.37	1 EA	2,800.00	2,800.00
0056	2542000000-E	846	1'-6" CONCRETE CURB & GUTTER	170 LF	21.00	3,570.00
0057	2549000000-E	846	2'-6" CONCRETE CURB & GUTTER	4,230 LF	30.25	127,957.50
0058	2570000000-N	SP	MODIFIED CONCRETE FLUME	1 EA	1,900.00	1,900.00
0059	2591000000-E	848	4" CONCRETE SIDEWALK	1,630 SY	55.00	89,650.00
0060	2605000000-N	848	CONCRETE CURB RAMPS	27 EA	2,500.00	67,500.00
0061	2612000000-E	848	6" CONCRETE DRIVEWAY	310 SY	91.25	28,287.50
0062	2619000000-E	850	4" CONCRETE PAVED DITCH	200 SY	162.00	32,400.00
0063	2655000000-E	852	5" MONOLITHIC CONCRETE ISLANDS (KEYED IN)	170 SY	88.50	15,045.00
0064	2724000000-E	857	PRECAST REINFORCED CONCRETE BARRIER, SINGLE FACED	580 LF	126.36	73,288.80
0065	2938000000-N	859	CONVERT EXISTING DROP INLET TO JUNCTION BOX WITH MANHOLE	1 EA	1,167.21	1,167.21

Line #	ItemNumber	Sec #	Description	Quantity Unit	Unit Bid Price	Amount Bid
0066	3001000000-N	SP	IMPACT ATTENUATOR UNITS, TYPE TL-3	2 EA	28,460.00	56,920.00
0067	3030000000-E	862	STEEL BEAM GUARDRAIL	300 LF	23.00	6,900.00
0068	3045000000-E	862	STEEL BEAM GUARDRAIL, SHOP CURVED	25 LF	24.00	600.00
0069	3105000000-N	862	STEEL BEAM GUARDRAIL TERMINAL SECTIONS (TES)	2 EA	90.00	180.00
0070	3215000000-N	862	GUARDRAIL ANCHOR UNITS, TYPE III	2 EA	2,350.00	4,700.00
0071	3288000000-N	862	GUARDRAIL END UNITS, TYPE TL-2	2 EA	3,250.00	6,500.00
0072	3317000000-N	862	GUARDRAIL ANCHOR UNITS, TYPE B-77	4 EA	2,600.00	10,400.00
0073	3500000000-E	866	WOVEN WIRE FENCE, **** FABRIC (48")	370 LF	7.00	2,590.00
0074	3506000000-E	866	4" TIMBER FENCE POSTS, ***** LONG (48")	27 EA	55.00	1,485.00
0075	3649000000-E	876	RIP RAP, CLASS B	30 TON	60.00	1,800.00
0076	3656000000-E	876	GEOTEXTILE FOR DRAINAGE	620 SY	4.00	2,480.00
0077	4054000000-E	902	PLAIN CONCRETE SIGN FOUNDATIONS	1 CY	10.00	10.00
0078	4060000000-E	903	SUPPORTS, BREAKAWAY STEEL BEAM	449 LB	22.00	9,878.00
0079	4072000000-E	903	SUPPORTS, 3-LB STEEL U-CHANNEL	860 LF	15.00	12,900.00
0080	4096000000-N	904	SIGN ERECTION, TYPE D	6 EA	200.00	1,200.00
0081	4102000000-N	904	SIGN ERECTION, TYPE E	25 EA	100.00	2,500.00
0082	4108000000-N	904	SIGN ERECTION, TYPE F	10 EA	200.00	2,000.00
0083	4110000000-N	904	SIGN ERECTION, TYPE *** (GROUND MOUNTED) (B)	3 EA	750.00	2,250.00
0084	4116100000-N	904	SIGN ERECTION, RELOCATE TYPE **** (GROUND MOUNTED) (D)	1 EA	300.00	300.00
0085	4155000000-N	907	DISPOSAL OF SIGN SYSTEM, U-CHANNEL	51 EA	1.00	51.00
0086	4400000000-E	1110	WORK ZONE SIGNS (STATIONARY)	1,011 SF	12.00	12,132.00

Line #	ItemNumber	Sec #	Description	Quantity Unit	Unit Bid Price	Amount Bid
0087	4405000000-E	1110	WORK ZONE SIGNS (PORTABLE)	172 SF	10.00	1,720.00
0088	4410000000-E	1110	WORK ZONE SIGNS (BARRICADE MOUNTED)	95 SF	7.00	665.00
0089	4415000000-N	1115	FLASHING ARROW BOARD	2 EA	4,995.00	9,990.00
0090	4420000000-N	1120	PORTABLE CHANGEABLE MESSAGE SIGN	4 EA	18,950.00	75,800.00
0091	4430000000-N	1130	DRUMS	120 EA	45.00	5,400.00
0092	4435000000-N	1135	CONES	60 EA	27.00	1,620.00
0093	4445000000-E	1145	BARRICADES (TYPE III)	264 LF	25.00	6,600.00
0094	4455000000-N	1150	FLAGGER	360 DAY	274.00	98,640.00
0095	4465000000-N	1160	TEMPORARY CRASH CUSHIONS	4 EA	9,250.00	37,000.00
0096	4480000000-N	1165	TMA	2 EA	6,800.00	13,600.00
0097	4485000000-E	1170	PORTABLE CONCRETE BARRIER	1,530 LF	41.65	63,724.50
0098	4490000000-E	1170	PORTABLE CONCRETE BARRIER (ANCHORED)	950 LF	62.90	59,755.00
0099	4505000000-E	1170	REMOVE & RESET PORTABLE CONCRETE BARRIER (ANCHORED)	520 LF	27.65	14,378.00
0100	4510000000-N	1190	LAW ENFORCEMENT	160 HR	65.00	10,400.00
0101	4516000000-N	1180	SKINNY DRUM	40 EA	36.00	1,440.00
0102	4650000000-N	1251	TEMPORARY RAISED PAVEMENT MARKERS	115 EA	8.00	920.00
0103	4695000000-E	1205	THERMOPLASTIC PAVEMENT MARKING LINES (8", 90 MILS)	832 LF	3.00	2,496.00
0104	4709000000-E	1205	THERMOPLASTIC PAVEMENT MARKING LINES (24", 90 MILS)	200 LF	15.00	3,000.00
0105	4720000000-E	1205	THERMOPLASTIC PAVEMENT MARKING CHARACTER (90 MILS)	4 EA	125.00	500.00
0106	4725000000-E	1205	THERMOPLASTIC PAVEMENT MARKING SYMBOL (90 MILS)	19 EA	150.00	2,850.00
0107	4770000000-E	1205	COLD APPLIED PLASTIC PAVEMENT MARKING LINES, TYPE ** (4") (IV)	555 LF	3.00	1,665.00
0108	4810000000-E	1205	PAINT PAVEMENT MARKING LINES (4")	29,917 LF	0.60	17,950.20

Line #	ItemNumber	Sec #	Description	Quantity Unit	Unit Bid Price	Amount Bid
0109	4820000000-E	1205	PAINT PAVEMENT MARKING LINES (8")	156 LF	1.00	156.00
0110	4835000000-E	1205	PAINT PAVEMENT MARKING LINES (24")	80 LF	10.00	800.00
0111	4845000000-N	1205	PAINT PAVEMENT MARKING SYMBOL	3 EA	100.00	300.00
0112	4846000000-E	1205	POLYUREA PAVEMENT MARKING LINES (***, *** MILS) (4", 20 MILS)	9,894 LF	2.10	20,777.40
0113	4846000000-E	1205	POLYUREA PAVEMENT MARKING LINES (***, *** MILS) (4", 30 MILS)	472 LF	2.20	1,038.40
0114	4846000000-E	1205	POLYUREA PAVEMENT MARKING LINES (***, *** MILS) (6", 20 MILS)	72 LF	2.50	180.00
0115	4846000000-E	1205	POLYUREA PAVEMENT MARKING LINES (***, *** MILS) (8", 20 MILS)	159 LF	2.75	437.25
0116	4850000000-E	1205	REMOVAL OF PAVEMENT MARKING LINES (4")	6,651 LF	1.50	9,976.50
0117	4900000000-N	1251	PERMANENT RAISED PAVEMENT MARKERS	4 EA	8.00	32.00
0118	4905100000-N	1253	NON-CAST IRON SNOWPLOWABLE PAVEMENT MARKER	157 EA	75.00	11,775.00
0119	5150000000-E	1409	ELECTRICAL DUCT, TYPE **, SIZE ***** (JA, 2")	350 LF	32.00	11,200.00
0120	5155000000-E	1409	ELECTRICAL DUCT, TYPE BD, SIZE ***** (2")	3,750 LF	13.50	50,625.00
0121	5240000000-N	1411	ELECTRICAL JUNCTION BOXES ***** (IG18)	2 EA	1,250.00	2,500.00
0122	5240000000-N	1411	ELECTRICAL JUNCTION BOXES ***** (IG30)	4 EA	2,250.00	9,000.00
0123	5255000000-N	1413	PORTABLE LIGHTING	LUMP SUM	50,000.00	50,000.00
0124	5260000000-N	SP	GENERIC LIGHTING ITEM ELECTRICAL CONDUIT SYSTEM AT STATION 22+71.80-L-	LUMP SUM	90,000.00	90,000.00
0125	5319000000-E	1505	CLASS B CONCRETE FOR ENCASING UTILITY LINES	3 CY	322.00	966.00
0126	5325600000-E	1510	6" WATER LINE	190 LF	251.00	47,690.00
0127	5325800000-E	1510	8" WATER LINE	568 LF	239.00	135,752.00

Line #	ItemNumber	Sec #	Description	Quantity Unit	Unit Bid Price	Amount Bid
0128	5326000000-E	1510	10" WATER LINE	1,706 LF	207.00	353,142.00
0129	5329000000-E	1510	DUCTILE IRON WATER PIPE FITTINGS	6,815 LB	12.00	81,780.00
0130	5540000000-E	1515	6" VALVE	6 EA	5,300.00	31,800.00
0131	5546000000-E	1515	8" VALVE	3 EA	5,350.00	16,050.00
0132	5552000000-E	1515	10" VALVE	7 EA	8,100.00	56,700.00
0133	5562000000-E	1515	*** INSERTION VALVE (10")	1 EA	34,300.00	34,300.00
0134	5562000000-E	1515	*** INSERTION VALVE (6")	2 EA	18,275.00	36,550.00
0135	5562000000-E	1515	*** INSERTION VALVE (8")	3 EA	21,200.00	63,600.00
0136	5648000000-N	1515	RELOCATE WATER METER	14 EA	1,850.00	25,900.00
0137	5666000000-N	1515	FIRE HYDRANT	3 EA	12,425.00	37,275.00
0138	5672000000-N	1515	RELOCATE FIRE HYDRANT	2 EA	5,760.00	11,520.00
0139	5673000000-E	1515	FIRE HYDRANT LEG	62 LF	315.00	19,530.00
0140	5686000000-E	1515	*** WATER SERVICE LINE (1")	363 LF	121.00	43,923.00
0141	5768000000-N	1520	SANITARY SEWER CLEAN-OUT	1 EA	2,680.00	2,680.00
0142	5768500000-E	1520	SEWER SERVICE LINE	10 LF	405.00	4,050.00
0143	5769000000-E	1520	DUCTILE IRON SEWER PIPE FITTINGS	45 LB	26.00	1,170.00
0144	5777000000-E	1525	6' DIA UTILITY MANHOLE	1 EA	18,400.00	18,400.00
0145	5783000000-E	1525	UTILITY MANHOLE WALL 6' DIA	3 LF	1,450.00	4,350.00
0146	5800000000-E	1530	ABANDON 6" UTILITY PIPE	50 LF	9.00	450.00
0147	5801000000-E	1530	ABANDON 8" UTILITY PIPE	871 LF	13.00	11,323.00
0148	5802000000-E	1530	ABANDON 10" UTILITY PIPE	1,622 LF	17.00	27,574.00
0149	5815000000-N	1530	REMOVE WATER METER	4 EA	670.00	2,680.00
0150	5828000000-N	1530	REMOVE UTILITY MANHOLE	3 EA	2,260.00	6,780.00

Line #	ItemNumber	Sec #	Description	Quantity Unit	Unit Bid Price	Amount Bid
0151	5835700000-E	1540	16" ENCASEMENT PIPE	20 LF	430.00	8,600.00
0152	5835900000-E	1540	20" ENCASEMENT PIPE	164 LF	225.00	36,900.00
0153	5872500000-E	1550	BORE AND JACK OF *** (20")	164 LF	721.00	118,244.00
0154	6000000000-E	1605	TEMPORARY SILT FENCE	4,820 LF	3.00	14,460.00
0155	6006000000-E	1610	STONE FOR EROSION CONTROL, CLASS A	630 TON	64.00	40,320.00
0156	6009000000-E	1610	STONE FOR EROSION CONTROL, CLASS B	335 TON	62.00	20,770.00
0157	6012000000-E	1610	SEDIMENT CONTROL STONE	775 TON	51.00	39,525.00
0158	6015000000-E	1615	TEMPORARY MULCHING	9 ACR	1,600.00	14,400.00
0159	6018000000-E	1620	SEED FOR TEMPORARY SEEDING	600 LB	5.00	3,000.00
0160	6021000000-E	1620	FERTILIZER FOR TEMPORARY SEEDING	4 TON	1,000.00	4,000.00
0161	6024000000-E	1622	TEMPORARY SLOPE DRAINS	200 LF	21.00	4,200.00
0162	6029000000-E	SP	SAFETY FENCE	440 LF	2.00	880.00
0163	6030000000-E	1630	SILT EXCAVATION	1,040 CY	9.00	9,360.00
0164	6036000000-E	1631	MATTING FOR EROSION CONTROL	11,700 SY	2.00	23,400.00
0165	6037000000-E	1629	COIR FIBER MAT	100 SY	5.00	500.00
0166	6042000000-E	1632	1/4" HARDWARE CLOTH	1,160 LF	0.30	348.00
0167	6043000000-E	1644	LOW PERMEABILITY GEOTEXTILE	100 SY	7.00	700.00
0168	6070000000-N	1639	SPECIAL STILLING BASINS	1 EA	800.00	800.00
0169	6071002000-E	1642	FLOCCULANT	220 LB	8.00	1,760.00
0170	6071012000-E	1642	COIR FIBER WATTLE	650 LF	13.00	8,450.00
0171	6071030000-E	1640	COIR FIBER BAFFLE	75 LF	7.00	525.00
0172	6071050000-E	1644	*** SKIMMER (1-1/2")	1 EA	1,800.00	1,800.00
0173	6084000000-E	1660	SEEDING & MULCHING	9 ACR	2,600.00	23,400.00

Line #	ItemNumber	Sec #	Description	Quantity Unit	Unit Bid Price	Amount Bid
0174	6087000000-E	1660	MOWING	4.5 ACR	175.00	787.50
0175	6090000000-E	1661	SEED FOR REPAIR SEEDING	100 LB	7.00	700.00
0176	6093000000-E	1661	FERTILIZER FOR REPAIR SEEDING	0.25 TON	1,175.00	293.75
0177	6096000000-E	1662	SEED FOR SUPPLEMENTAL SEEDING	175 LB	7.00	1,225.00
0178	6108000000-E	1665	FERTILIZER TOPDRESSING	5.25 TON	1,175.00	6,168.75
0179	6114500000-N	1667	SPECIALIZED HAND MOWING	10 MHR	45.00	450.00
0180	6114800000-N	SP	MANUAL LITTER REMOVAL	4 MHR	145.00	580.00
0181	6114900000-E	SP	LITTER DISPOSAL	1 TON	750.00	750.00
0182	6117000000-N	1675	RESPONSE FOR EROSION CONTROL	18 EA	300.00	5,400.00
0183	6117500000-N	SP	CONCRETE WASHOUT STRUCTURE	2 EA	1,000.00	2,000.00
0184	6132000000-N	SP	GENERIC EROSION CONTROL ITEM FABRIC INSERT INLET PROTECTION - (TYPE 2)	3 EA	100.00	300.00
0185	6132000000-N	SP	GENERIC EROSION CONTROL ITEM FABRIC INSERT INLET PROTECTION CLEANOUT	6 EA	300.00	1,800.00
0186	7048500000-E	1705	PEDESTRIAN SIGNAL HEAD (16", 1 SECTION W/COUNTDOWN)	10 EA	1,340.00	13,400.00
0187	7060000000-E	1705	SIGNAL CABLE	3,510 LF	4.00	14,040.00
0188	7120000000-E	1705	VEHICLE SIGNAL HEAD (12", 3 SECTION)	22 EA	1,150.00	25,300.00
0189	7132000000-E	1705	VEHICLE SIGNAL HEAD (12", 4 SECTION)	1 EA	1,300.00	1,300.00
0190	7264000000-E	1710	MESSENGER CABLE (3/8")	500 LF	10.00	5,000.00
0191	7288000000-E	1715	PAVED TRENCHING (***** (1, 2")	25 LF	55.00	1,375.00
0192	7300000000-E	1715	UNPAVED TRENCHING (***** (1, 2")	760 LF	13.50	10,260.00
0193	7300000000-E	1715	UNPAVED TRENCHING (***** (2, 2")	150 LF	20.00	3,000.00
0194	7300000000-E	1715	UNPAVED TRENCHING (***** (3, 2")	50 LF	30.00	1,500.00
0195	7301000000-E	1715	DIRECTIONAL DRILL (***** (2, 2")	1,425 LF	42.00	59,850.00

Line #	ItemNumber	Sec #	Description	Quantity Unit	Unit Bid Price	Amount Bid
0196	7324000000-N	1716	JUNCTION BOX (STANDARD SIZE)	11 EA	625.00	6,875.00
0197	7348000000-N	1716	JUNCTION BOX (OVER-SIZED, HEAVY DUTY)	8 EA	1,275.00	10,200.00
0198	7360000000-N	1720	WOOD POLE	4 EA	1,350.00	5,400.00
0199	7372000000-N	1721	GUY ASSEMBLY	16 EA	800.00	12,800.00
0200	7408000000-E	1722	1" RISER WITH WEATHERHEAD	1 EA	500.00	500.00
0201	7420000000-E	1722	2" RISER WITH WEATHERHEAD	3 EA	1,000.00	3,000.00
0202	7432000000-E	1722	2" RISER WITH HEAT SHRINK TUBING	1 EA	1,500.00	1,500.00
0203	7444000000-E	1725	INDUCTIVE LOOP SAWCUT	1,100 LF	12.50	13,750.00
0204	7456100000-E	1726	LEAD-IN CABLE (14-2)	3,350 LF	2.00	6,700.00
0205	7516000000-E	1730	COMMUNICATIONS CABLE (** FIBER) (12)	260 LF	5.00	1,300.00
0206	7516000000-E	1730	COMMUNICATIONS CABLE (** FIBER) (24)	700 LF	4.50	3,150.00
0207	7528000000-E	1730	DROP CABLE	200 LF	4.50	900.00
0208	7540000000-N	1731	SPLICE ENCLOSURE	1 EA	1,950.00	1,950.00
0209	7541000000-N	1731	MODIFY SPLICE ENCLOSURE	1 EA	1,400.00	1,400.00
0210	7552000000-N	1731	INTERCONNECT CENTER	1 EA	2,500.00	2,500.00
0211	7566000000-N	1733	DELINEATOR MARKER	1 EA	200.00	200.00
0212	7588000000-N	SP	METAL POLE WITH SINGLE MAST ARM	6 EA	22,220.00	133,320.00
0213	7613000000-N	SP	SOIL TEST	6 EA	1,350.00	8,100.00
0214	7614100000-E	SP	DRILLED PIER FOUNDATION	36 CY	1,500.00	54,000.00
0215	7631000000-N	SP	MAST ARM WITH METAL POLE DESIGN	6 EA	25.00	150.00
0216	7636000000-N	1745	SIGN FOR SIGNALS	4 EA	325.00	1,300.00
0217	7642100000-N	1743	TYPE I POST WITH FOUNDATION	3 EA	2,600.00	7,800.00
0218	7642200000-N	1743	TYPE II PEDESTAL WITH FOUNDATION	5 EA	3,200.00	16,000.00

Line #	ItemNumber	Sec #	Description	Quantity Unit	Unit Bid Price	Amount Bid
0219	7684000000-N	1750	SIGNAL CABINET FOUNDATION	2 EA	3,200.00	6,400.00
0220	7696000000-N	1751	CONTROLLERS WITH CABINET (***** (TYPE 2070LX, BASE MOUNTED)	2 EA	26,500.00	53,000.00
0221	7744000000-N	1751	DETECTOR CARD (TYPE 170)	8 EA	275.00	2,200.00
0222	7901000000-N	1753	CABINET BASE EXTENDER	2 EA	800.00	1,600.00
0223	7980000000-N	SP	GENERIC SIGNAL ITEM ETHERNET EDGE SWITCH	1 EA	4,500.00	4,500.00
0224	7980000000-N	SP	GENERIC SIGNAL ITEM MICROWAVE VEHICLE DETECTION SYSTEM - MULTIPLE ZONES	1 EA	37,500.00	37,500.00
0225	7980000000-N	SP	GENERIC SIGNAL ITEM MODIFY EXISTING VEHICLE SIGNALHEAD	4 EA	150.00	600.00

Contract Item Sheets For C204410

Line #	ItemNumber	Sec #	Description	Quantity Unit	Unit Bid Price	Amount Bid
WALL ITEMS						
0226	8801000000-E	SP	MSE RETAINING WALL NO **** (W1)	2,300 SF	150.00	345,000.00
0227	8801000000-E	SP	MSE RETAINING WALL NO **** (W2)	7,300 SF	100.00	730,000.00
0228	8847000000-E	SP	GENERIC RETAINING WALL ITEM ARCHITECTURAL CONCRETE SURFACE TREATMENT	7,750 SF	12.00	93,000.00

Line #	ItemNumber	Sec #	Description	Quantity Unit	Unit Bid Price	Amount Bid
STRUCTURE ITEMS						
0229	8035000000-N	402	REMOVAL OF EXISTING STRUCTURE AT STATION ***** (22+71.80 -L-)	LUMP SUM	150,000.00	150,000.00
0230	8065000000-N	SP	ASBESTOS ASSESSMENT	LUMP SUM	1,400.00	1,400.00
0231	8091000000-N	410	FOUNDATION EXCAVATION FOR BENT NO ** AT STATION ***** (22+71.80 -L-)	LUMP SUM	2,500.00	2,500.00
0232	8121000000-N	412	UNCLASSIFIED STRUCTURE EXCAVATION AT STATION ***** (22+71.80 -L-)	LUMP SUM	35,000.00	35,000.00
0233	8147000000-E	420	REINFORCED CONCRETE DECK SLAB	10,341 SF	60.00	620,460.00
0234	8161000000-E	420	GROOVING BRIDGE FLOORS	9,425 SF	1.50	14,137.50
0235	8182000000-E	420	CLASS A CONCRETE (BRIDGE)	266.9 CY	1,200.00	320,280.00
0236	8210000000-N	422	BRIDGE APPROACH SLABS, STATION ***** (22+71.80 -L-)	LUMP SUM	120,000.00	120,000.00
0237	8217000000-E	425	REINFORCING STEEL (BRIDGE)	38,558 LB	2.00	77,116.00
0238	8238000000-E	425	SPIRAL COLUMN REINFORCING STEEL (BRIDGE)	2,047 LB	3.00	6,141.00
0239	8265000000-E	430	54" PRESTRESSED CONCRETE GIRDERS	1,247.17 LF	400.00	498,868.00
0240	8328200000-E	450	PILE DRIVING EQUIPMENT SETUP FOR *** STEEL PILES (HP 12 X 53)	46 EA	650.00	29,900.00
0241	8364000000-E	450	HP 12 X 53 STEEL PILES	3,145 LF	50.00	157,250.00
0242	8391000000-N	450	STEEL PILE POINTS	24 EA	150.00	3,600.00
0243	8393000000-N	450	PILE REDRIVES	24 EA	500.00	12,000.00
0244	8394000000-N	450	DYNAMIC PILE TESTING	1 EA	3,000.00	3,000.00
0245	8531000000-E	462	4" SLOPE PROTECTION	118.2 SY	140.00	16,548.00
0246	8657000000-N	430	ELASTOMERIC BEARINGS	LUMP SUM	10,000.00	10,000.00
0247	8860000000-N	SP	GENERIC STRUCTURE ITEM STRIP SEAL EXPANSION JOINTS	LUMP SUM	100,000.00	100,000.00
0248	8867000000-E	SP	GENERIC STRUCTURE ITEM CLASSIC CONCRETE BRIDGE RAIL	360.7 LF	400.00	144,280.00

Line #	ItemNumber	Sec #	Description	Quantity Unit	Unit Bid Price	Amount Bid
TOTAL AMOUNT OF BID FOR ENTIRE PROJECT						\$11,657,111.76

1421/Apr24/Q233910.97/D1203860894000/E248

Contract No. C204410
County Wake

Rev. 1-16-18

**EXECUTION OF CONTRACT
NON-COLLUSION, DEBARMENT AND GIFT BAN CERTIFICATION**

CORPORATION

The Contractor declares (or certifies, verifies, or states) under penalty of perjury under the laws of the United States that neither he, nor any official, agent or employee has entered into any agreement, participated in any collusion, or otherwise taken any action which is in restraint of free competitive bidding in connection with this Contract, that the Contractor has not been convicted of violating *N.C.G.S. § 133-24* within the last three years, and that the Contractor intends to do the work with its own bona fide employees or subcontractors and did not bid for the benefit of another contractor.

By submitting this Execution of Contract, Non-Collusion and Debarment Certification, the Contractor is certifying his status under penalty of perjury under the laws of the United States in accordance with the Debarment Certification attached, provided that the Debarment Certification also includes any required statements concerning exceptions that are applicable.

N.C.G.S. § 133-32 and Executive Order 24 prohibit the offer to, or acceptance by, any State Employee of any gift from anyone with a contract with the State, or from any person seeking to do business with the State. By execution of any response in this procurement, you attest, for your entire organization and its employees or agents, that you are not aware that any such gift has been offered, accepted, or promised by any employees of your organization.

SIGNATURE OF CONTRACTOR

Blythe Construction, Inc.

Full name of Corporation

PO Box 31635, Charlotte, North Carolina 28231

Address as Prequalified

Attest



Secretary/Assistant Secretary
Select appropriate title

By

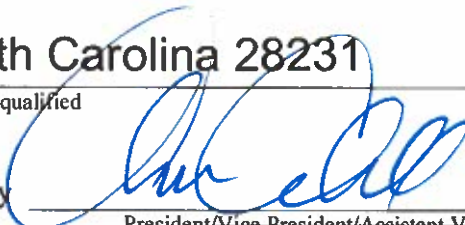

President/Vice President/Assistant Vice
President Select appropriate title

Lawrence G. Schmidt, II

Print or type Signer's name

Alan Cahill

Print or type Signer's name

CORPORATE SEAL



DEBARMENT CERTIFICATION

Conditions for certification:

1. The prequalified bidder shall provide immediate written notice to the Department if at any time the bidder learns that his certification was erroneous when he submitted his debarment certification or explanation filed with the Department, or has become erroneous because of changed circumstances.
2. The terms *covered transaction, debarred, suspended, ineligible, lower tier covered transaction, participant, person, primary covered transaction, principal, proposal, and voluntarily excluded*, as used in this provision, have the meanings set out in the Definitions and Coverage sections of the rules implementing Executive Order 12549. A copy of the Federal Rules requiring this certification and detailing the definitions and coverages may be obtained from the Contract Officer of the Department.
3. The prequalified bidder agrees by submitting this form, that he will not knowingly enter into any lower tier covered transaction with a person who is debarred, suspended, declared ineligible, or voluntarily excluded from participation in NCDOT contracts, unless authorized by the Department.
4. For Federal Aid projects, the prequalified bidder further agrees that by submitting this form he will include the Federal-Aid Provision titled *Required Contract Provisions Federal-Aid Construction Contract (Form FHWA PR 1273)* provided by the Department, without subsequent modification, in all lower tier covered transactions.
5. The prequalified bidder may rely upon a certification of a participant in a lower tier covered transaction that he is not debarred, suspended, ineligible, or voluntarily excluded from the covered transaction, unless he knows that the certification is erroneous. The bidder may decide the method and frequency by which he will determine the eligibility of his subcontractors.
6. Nothing contained in the foregoing shall be construed to require establishment of a system of records in order to render in good faith the certification required by this provision. The knowledge and information of a participant is not required to exceed that which is normally possessed by a prudent person in the ordinary course of business dealings.
7. Except as authorized in paragraph 6 herein, the Department may terminate any contract if the bidder knowingly enters into a lower tier covered transaction with a person who is suspended, debarred, ineligible, or voluntarily excluded from participation in this transaction, in addition to other remedies available by the Federal Government.

DEBARMENT CERTIFICATION

The prequalified bidder certifies to the best of his knowledge and belief, that he and his principals:

- a. Are not presently debarred, suspended, proposed for debarment, declared ineligible, or voluntarily excluded from covered transactions by any Federal department or agency;
- b. Have not within a three-year period preceding this proposal been convicted of or had a civil judgment rendered against them for commission of fraud or a criminal offense in connection with obtaining, attempting to obtain, or performing a public (Federal, State or local) transaction or contract under a public transaction; violation of Federal or State antitrust statutes or commission of embezzlement, theft, forgery, bribery, falsification or destruction of records; making false statements; or receiving stolen property;
- c. Are not presently indicted for or otherwise criminally or civilly charged by a governmental entity (Federal, State or local) with commission of any of the offenses enumerated in paragraph b. of this certification; and
- d. Have not within a three-year period preceding this proposal had one or more public transactions (Federal, State or local) terminated for cause or default.
- e. Will submit a revised Debarment Certification immediately if his status changes and will show in his bid proposal an explanation for the change in status.

If the prequalified bidder cannot certify that he is not debarred, he shall provide an explanation with this submittal. An explanation will not necessarily result in denial of participation in a contract.

Failure to submit a non-collusion and debarment certification will result in the prequalified bidder's bid being considered non-responsive.

Check here if an explanation is attached to this certification.

Contract No. **C204410**

County (ies): **Wake**

ACCEPTED BY THE
DEPARTMENT OF TRANSPORTATION

DocuSigned by:

Ronald E. Davenport, Jr.

52C46046381F443...

Contract Officer

05/08/2024

Date

Execution of Contract and Bonds
Approved as to Form:

DocuSigned by:

Justin Bradley

B211A5422113486...

Attorney General

05/08/2024

Date

Signature Sheet (Bid - Acceptance by Department)

Contract No. C204410
County Wake

Rev 5-17-11

Bond No. 016243933

CONTRACT PAYMENT BOND

Date of Payment Bond Execution 4/30/2024

Name of Principal Contractor BLYTHE CONSTRUCTION, INC.
P.O. Box 31635, Charlotte, NC, 28231

Name of Surety: LIBERTY MUTUAL INSURANCE COMPANY
175 Berkeley Street, Boston, MA, 02116

Name of Contracting Body: North Carolina Department of Transportation
Raleigh, North Carolina

Amount of Bond: \$11,657,111.76

Contract ID No.: C204410

County Name: Wake

KNOW ALL MEN BY THESE PRESENTS, That we, the PRINCIPAL CONTRACTOR (hereafter, PRINCIPAL) and SURETY above named, are held and firmly bound unto the above named Contracting Body, hereinafter called the Contracting Body, in the penal sum of the amount stated above for the payment of which sum well and truly to be made, we bind ourselves, our heirs, executors, administrators, and successors, jointly and severally, firmly by these presents.

THE CONDITION OF THIS OBLIGATION IS SUCH, that whereas the principal entered into a certain contract with the Contracting Body, numbered as shown above and hereto attached:

NOW THEREFORE, if the principal shall promptly make payment to all persons supplying labor and material in the prosecution of the work provided for in said contract, and any and all duly authorized modifications of said contract that may hereafter be made, notice of which modifications to the surety being hereby waived, then this obligation to be void; otherwise to remain in full force and virtue.

IN WITNESS WHEREOF, the above-bound parties have executed this instrument under their several seals on the date indicated above, the name and corporate seal of each corporate party being hereto affixed and these presents duly signed by its undersigned representative, pursuant to authority of its governing body.

Contract No. C204410
County Wake

Rev 5-17-11

CONTRACT PAYMENT BOND

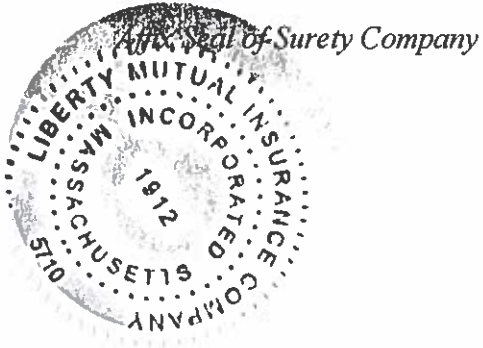

LIBERTY MUTUAL INSURANCE COMPANY
Print or type Surety Company Name

By Sandra Diaz
Print, stamp or type name of Attorney-in-Fact

Signature of Attorney-in-Fact

Signature of Witness

Grace Laterza
Print or type Signer's name

175 Berkeley Street, Boston, MA, 02116
Address of Attorney-in-Fact

Contract No. C204410
County Wake

Rev 5-17-11

CONTRACT PAYMENT BOND

CORPORATION

SIGNATURE OF CONTRACTOR (Principal)

BLYTHE CONSTRUCTION, INC.
Full name of Corporation

P.O. Box 31635, Charlotte, NC28231
Address as prequalified

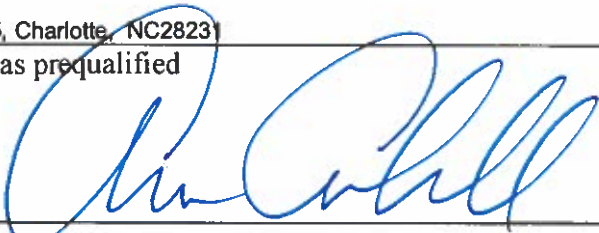
By 
Signature of President, ~~Vice President, Assistant Vice President~~
Select appropriate title

Alan M. Cahill, President & CEO
Print or type Signer's name

Affix Corporate Seal



Attest 
Signature of ~~Secretary~~, Assistant Secretary
Select appropriate title

Lawrence G. Schmidt, II, Asst. Sec.
Print or type Signer's name

Contract No. C204410
County Wake

Rev 5-17-11

Bond No. 016243933

CONTRACT PERFORMANCE BOND

Date of Performance Bond Execution: 4/30/2024

Name of Principal Contractor: BLYTHE CONSTRUCTION, INC.
P.O. Box 31635, Charlotte, NC, 28231

Name of Surety: LIBERTY MUTUAL INSURANCE COMPANY
175 Berkeley Street, Boston, MA, 02116

Name of Contracting Body: North Carolina Department of Transportation
Raleigh, North Carolina

Amount of Bond: \$11,657,111.76

Contract ID No.: C204410

County Name: Wake

KNOW ALL MEN BY THESE PRESENTS, That we, the PRINCIPAL CONTRACTOR (hereafter, PRINCIPAL) and SURETY above named, are held and firmly bound unto the above named Contracting Body, hereinafter called the Contracting Body, in the penal sum of the amount stated above for the payment of which sum well and truly to be made, we bind ourselves, our heirs, executors, administrators, and successors, jointly and severally, firmly by these presents.

THE CONDITION OF THIS OBLIGATION IS SUCH, that whereas the principal entered into a certain contract with the Contracting Body, numbered as shown above and hereto attached:

NOW THEREFORE, if the principal shall well and truly perform and fulfill all the undertakings, covenants, terms, conditions, and agreements of said contract during the original term of said contract and any extensions thereof that may be granted by the Contracting Body, with or without notice to the Surety, and during the life of any guaranty required under the contract, and shall also well and truly perform and fulfill all the undertakings, covenants, terms, conditions, and agreements of any and all duly authorized modifications of said contract that may hereafter be made, notice of which modifications to the surety being hereby waived, then this obligation to be void; otherwise to remain in full force and virtue.

IN WITNESS WHEREOF, the above-bound parties have executed this instrument under their several seals on the date indicated above, the name and corporate seal of each corporate party being hereto affixed and these presents duly signed by its undersigned representative, pursuant to authority of its governing body.

Contract No. C204410
County Wake

Rev 5-17-11

CONTRACT PERFORMANCE BOND

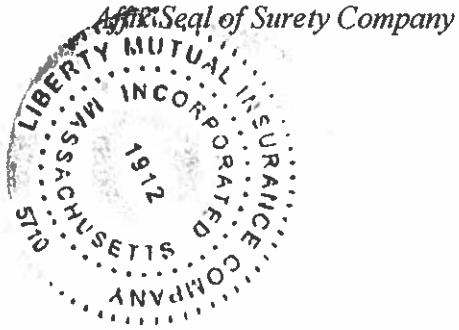

LIBERTY MUTUAL INSURANCE COMPANY
Print or type Surety Company Name

By Sandra Diaz
Print, stamp or type name of Attorney-in-Fact

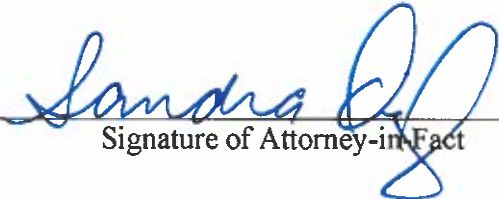
Signature of Attorney-in-Fact

Signature of Witness

Grace Laterza
Print or type Signer's name

175 Berkeley Street, Boston, MA, 02116
Address of Attorney-in-Fact

CONTRACT PERFORMANCE BOND

CORPORATION

SIGNATURE OF CONTRACTOR (Principal)

BLYTHE CONSTRUCTION, INC.

Full name of Corporation

P.O. Box 31635, Charlotte, NC28231

Address as prequalified

By 

Signature of President, ~~Vice President~~, Assistant ~~Vice President~~
Select appropriate title

Alan M. Cahill, President & CEO

Print or type Signer's name

Affix Corporate Seal



Attest



Signature of ~~Secretary~~, Assistant Secretary
Select appropriate title

Lawrence G. Schmidt, II, Asst. Sec.

Print or type Signer's name



This Power of Attorney limits the acts of those named herein, and they have no authority to bind the Company except in the manner and to the extent herein stated.

Liberty Mutual Insurance Company
The Ohio Casualty Insurance Company
West American Insurance Company

Certificate No: 8210937- 015009

POWER OF ATTORNEY

KNOWN ALL PERSONS BY THESE PRESENTS: That The Ohio Casualty Insurance Company is a corporation duly organized under the laws of the State of New Hampshire, that Liberty Mutual Insurance Company is a corporation duly organized under the laws of the State of Massachusetts, and West American Insurance Company is a corporation duly organized under the laws of the State of Indiana (herein collectively called the "Companies"), pursuant to and by authority herein set forth, does hereby name, constitute and appoint, Debra A. Deming, Sandra Diaz, Vilma Gonzalez, Peter Healy, Pablo Garcia Horcajo, Jennifer L. Jakaitis, Francesca Kazmierczak, Aklima Noorhassan, Anne Potter, Frances Rodriguez, Valorie Spates, Susan A. Welsh, Beverly A. Woolford

all of the city of New York state of NY each individually if there be more than one named, its true and lawful attorney-in-fact to make, execute, seal, acknowledge and deliver, for and on its behalf as surety and as its act and deed, any and all undertakings, bonds, recognizances and other surety obligations, in pursuance of these presents and shall be as binding upon the Companies as if they have been duly signed by the president and attested by the secretary of the Companies in their own proper persons

IN WITNESS WHEREOF, this Power of Attorney has been subscribed by an authorized officer or official of the Companies and the corporate seals of the Companies have been affixed thereto this 6th day of November, 2023



Liberty Mutual Insurance Company
The Ohio Casualty Insurance Company
West American Insurance Company

By: David M. Carey
David M. Carey, Assistant Secretary

Not valid for mortgage, note, loan, letter of credit, currency rate, interest rate or residual value guarantees.

State of PENNSYLVANIA ss
County of MONTGOMERY

On this 6th day of November, 2023 before me personally appeared David M. Carey, who acknowledged himself to be the Assistant Secretary of Liberty Mutual Insurance Company, The Ohio Casualty Company, and West American Insurance Company, and that he, as such, being authorized so to do, execute the foregoing instrument for the purposes therein contained by signing on behalf of the corporations by himself as a duly authorized officer.

IN WITNESS WHEREOF, I have hereunto subscribed my name and affixed my notarial seal at Plymouth Meeting, Pennsylvania, on the day and year first above written.



Commonwealth of Pennsylvania - Notary Seal
Teresa Pastella, Notary Public
Montgomery County
My commission expires March 28, 2025
Commission number 1126044
Member, Pennsylvania Association of Notaries

By: Teresa Pastella
Teresa Pastella, Notary Public

This Power of Attorney is made and executed pursuant to and by authority of the following By-laws and Authorizations of The Ohio Casualty Insurance Company, Liberty Mutual Insurance Company, and West American Insurance Company which resolutions are now in full force and effect reading as follows:

ARTICLE IV - OFFICERS: Section 12. Power of Attorney.

Any officer or other official of the Corporation authorized for that purpose in writing by the Chairman or the President, and subject to such limitation as the Chairman or the President may prescribe, shall appoint such attorneys-in-fact, as may be necessary to act in behalf of the Corporation to make, execute, seal, acknowledge and deliver as surety any and all undertakings, bonds, recognizances and other surety obligations. Such attorneys-in-fact, subject to the limitations set forth in their respective powers of attorney, shall have full power to bind the Corporation by their signature and execution of any such instruments and to attach thereto the seal of the Corporation. When so executed, such instruments shall be as binding as if signed by the President and attested to by the Secretary. Any power or authority granted to any representative or attorney-in-fact under the provisions of this article may be revoked at any time by the Board, the Chairman, the President or by the officer or officers granting such power or authority.

ARTICLE XIII - Execution of Contracts: Section 5. Surety Bonds and Undertakings.

Any officer of the Company authorized for that purpose in writing by the chairman or the president, and subject to such limitations as the chairman or the president may prescribe, shall appoint such attorneys-in-fact, as may be necessary to act in behalf of the Company to make, execute, seal, acknowledge and deliver as surety any and all undertakings, bonds, recognizances and other surety obligations. Such attorneys-in-fact subject to the limitations set forth in their respective powers of attorney, shall have full power to bind the Company by their signature and execution of any such instruments and to attach thereto the seal of the Company. When so executed such instruments shall be as binding as if signed by the president and attested by the secretary.

Certificate of Designation - The President of the Company, acting pursuant to the Bylaws of the Company, authorizes David M. Carey, Assistant Secretary to appoint such attorneys-in-fact as may be necessary to act on behalf of the Company to make, execute, seal, acknowledge and deliver as surety any and all undertakings, bonds, recognizances and other surety obligations.

Authorization - By unanimous consent of the Company's Board of Directors, the Company consents that facsimile or mechanically reproduced signature of any assistant secretary of the Company, wherever appearing upon a certified copy of any power of attorney issued by the Company in connection with surety bonds, shall be valid and binding upon the Company with the same force and effect as though made in person.

I, Renee C. Llewellyn, the undersigned Assistant Secretary, The Ohio Casualty Insurance Company, Liberty Mutual Insurance Company, and West American Insurance Company do hereby certify that the original power of attorney of which the foregoing is a full, true and correct copy of the Power of Attorney executed by said Companies, is in full force and effect and has not been revoked.

IN TESTIMONY WHEREOF, I have hereunto set my hand and affixed the seals of said Companies this 30th day of April, 2024.



By: Renee C. Llewellyn
Renee C. Llewellyn, Assistant Secretary

For bond and/or Power of Attorney (POA) verification inquiries, please call 610-832-8240 or email HOSUR@libertymutual.com.